

First Steps Towards a Symplectic Dynamics

B. Bramham and H. Hofer

CONTENTS

1. What Should Symplectic Dynamics be?	127
2. Holomorphic Curves	130
2.1. Contact Forms and Holomorphic Curves	131
2.2. Notions of Energy	133
2.3. Global Systems of Surfaces of Section	135
3. Holomorphic Curves and Disk Maps	141
3.1. Reeb-like Mapping Tori	142
3.2. Notions of Rotation Number	144
3.3. Finite Energy Foliations for Mapping Tori	146
3.4. A Proof of the Poincaré-Birkhoff Fixed Point Theorem	153
3.5. A Proof of a Theorem of Franks and Handel	157
4. Asymptotic Foliations for Disk Maps	163
4.1. Detecting Invariant Circles	164
4.2. Speculations on Pseudo-Rotations	169
4.3. Questions about the Asymptotic Behavior of Finite Energy Foliations and Disk Maps	172
Acknowledgment	173
References	174

1. What Should Symplectic Dynamics be?

Many interesting physical systems have mathematical descriptions as finite-dimensional or infinite-dimensional Hamiltonian systems. According to A. Weinstein, [76], Lagrange was the first to notice that the dynamical systems occurring in the mathematical description of the motion of the planets can be written in a particular form, which we call today a Hamiltonian system. Poincaré who started the modern theory of dynamical systems and symplectic geometry developed a particular viewpoint combining geometric and dynamical systems ideas in the study of Hamiltonian systems. After

Poincaré the field of dynamical systems and the field of symplectic geometry developed separately. Both fields have rich theories and the time seems ripe to develop the common core with highly integrated ideas from both fields. Given the state of both fields this looks like a promising undertaking. Though it is difficult to predict what “Symplectic Dynamics” ultimately will be, it is not difficult to give examples which show how dynamical systems questions and symplectic ideas come together in a nontrivial way.

Assume we have a cylinder, where the flow on the boundary is standard. The flow-lines enter in a standard way on the left and leave in a standard way on the right, see Figure 1. Here is the question: What must happen in the tube, assuming there are no rest points, so that not all flow-lines entering on the left will leave on the right?

It is easy to modify the flow by introducing a pair of periodic orbits with the desired properties, see Figure 2.

One could ask next whether we can achieve the desired effect without periodic orbits. That turns out to be a very hard question and is closely related to the Seifert conjecture, [71]. It was solved in the category of smooth vector fields by K. Kuperberg in 1993, [54]. One can modify the flow smoothly (even real analytically), without rest points and periodic orbits, so that not all orbits go through. In the category of volume-preserving flows, G. Kuperberg, [53], showed that the same holds on the C^1 -level. Modulo the question of whether G. Kuperberg’s example can be made smooth it seems that there cannot be any interesting additional contribution. However, it is precisely here where things become even more interesting and where we obtain a first glimpse of a “Symplectic Dynamics”.

Fix on a compact three-manifold M (perhaps with boundary) a volume form Ω . A vector field X is volume preserving provided $L_X\Omega = 0$. By the Cartan homotopy formula this means that

$$0 = i_X d\Omega + di_X\Omega = d(i_X\Omega).$$

Let us assume for the moment that $H^1(M) = H^2(M) = 0$. Then we find a 1-form Γ_0 with

$$i_X\Omega = d\Gamma_0$$

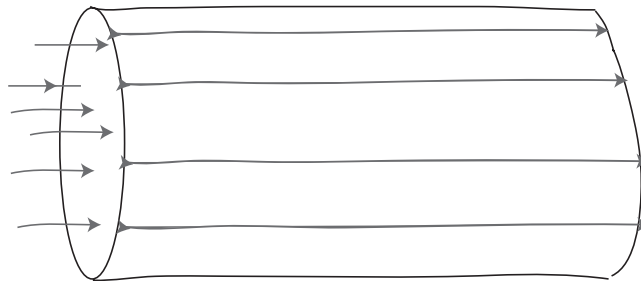

FIGURE 1. A flow tube with a flow being standard at the boundary.

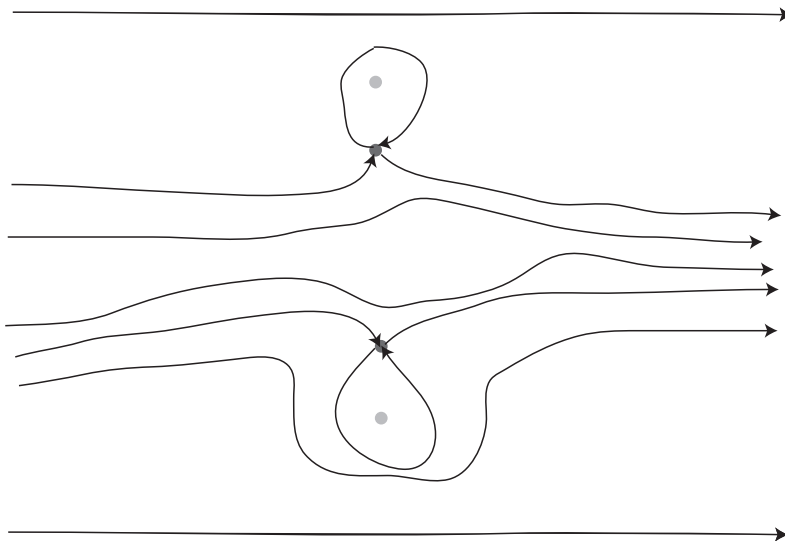

FIGURE 2. Two periodic orbits are introduced in order to have a flow without rest points, but not all flow lines entering left leave on the right.

and any 1-form Γ with that property can be written as

$$\Gamma = \Gamma_0 + dh$$

for a smooth map h .

Consider the collection \mathcal{V} of all smooth nowhere vanishing Ω -preserving vector fields. Among these there is the interesting subset \mathcal{V}^* consisting of those vector fields X for which there exists a Γ with $d\Gamma = i_X\Omega$, and so that $\Gamma(X) > 0$. Observe that if $X' \in \mathcal{V}$ is close to X we still have that $i_{X'}\Omega = d\Gamma'$ for a Γ' close to Γ and consequently $\Gamma'(X') > 0$ (by the compactness of M). So we see that \mathcal{V}^* is open in \mathcal{V} , in for example the C^1 -topology, provided $H^1(M) = H^2(M) = 0$.

DEFINITION 1.1. Let (M, Ω) be a closed three-manifold equipped with a volume form. An Ω -preserving vector field X is called *Reeb-like* provided there exist a one-form Γ satisfying $d\Gamma = i_X\Omega$ and $\Gamma(X) > 0$ at all points of M .

Assume that X is Reeb-like, so that $\Gamma(X) > 0$ for some Γ with $d\Gamma = i_X\Omega$. Note that this implies that $\Gamma \wedge d\Gamma$ is a volume form. In other words Γ is a contact form.

Define a positive function f by

$$f = \frac{1}{\Gamma(X)}.$$

Then $Y = fX$ satisfies $\Gamma(Y) = 1$ and $d\Gamma(Y, \cdot) = i_Y d\Gamma = fi_X i_X \Omega = 0$. In particular

$$L_Y(\Gamma \wedge d\Gamma) = 0.$$

So Y is Reeb-like for the modified volume form $\Gamma \wedge d\Gamma$, but satisfies the stronger condition $\Gamma(Y) = 1$. Observe that Y and X have the same unparameterized flow lines. So for many questions one can study Y rather than X .

DEFINITION 1.2. Let M be a compact three-manifold. A *Reeb vector field* on M is a vector field for which there exists a contact form λ with $\lambda(X) = 1$ and $d\lambda(X, \cdot) = 0$.

In [23] it was shown that if for a Reeb-like vector field not all orbits pass through, then there exists a periodic orbit. More precisely the method of proof in this paper shows the following result, where D is the closed unit disk in \mathbb{R}^2 .

THEOREM 1.3 (Eliashberg-Hofer). *Let $Z = [0, 1] \times D$ with coordinates (z, x, y) equipped with a contact form λ which near $z = 0$ or $z = 1$ and $x^2 + y^2 = 1$ has the form $dz + xdy$, so that close to the boundary the associated Reeb vector field is given by $(1, 0, 0)$. Then, if not all entering orbits go through, there has to be a periodic orbit inside Z .*

In other words, complicated Reeb dynamics produces periodic orbits. But even much more is true as we shall see. There is a holomorphic curve theory, in the spirit of [36], related to the dynamics of Reeb-like vector fields, see [41]. The holomorphic curves allow to quantify the complexity of the dynamics in terms of periodic orbits and relations between them. The latter are again expressed in terms of holomorphic curves. Symplectic field theory (SFT), [22], uses the same ingredients to derive contact and symplectic invariants. However, it is possible to shift the focus onto the dynamical aspects. The already strongly developed SFT gives an idea of the possible richness of the theory one might expect. This is precisely the key observation which indicates that there should be a field accurately described as ‘‘Symplectic Dynamics’’ with ideas and techniques based on the close relationship between dynamics and associated holomorphic curve theories, as they occur in symplectic geometry and topology. Our paper describes some of the observations.

2. Holomorphic Curves

In the first subsection we introduce the holomorphic curve theory associated to a contact form on a three-dimensional manifold. This can also be done in higher dimensions. However, we shall restrict ourselves to low dimensions. Here the results which can be obtained look the strongest.

2.1. Contact Forms and Holomorphic Curves. Consider a three-manifold M equipped with a contact form λ . The Reeb vector field associated to λ is denoted by X and, as previously explained, defined by

$$i_X \lambda = 1 \quad \text{and} \quad i_X d\lambda = 0.$$

There is another piece of data associated to λ . Namely the *contact structure* ξ defined as the kernel bundle associated to λ . The form $d\lambda$ defines on the fibers of $\xi \rightarrow M$ a symplectic structure. Consequently, λ gives us a canonical way to split the tangent space TM of M into a line bundle L with preferred section X and a symplectic vector bundle $(\xi, d\lambda)$:

$$TM \equiv (L, X) \oplus (\xi, d\lambda).$$

We can pick a complex structure J for ξ , so that $d\lambda(h, Jh) > 0$ for $h \neq 0$. Then we can extend J to an \mathbb{R} -invariant almost complex structure \tilde{J} on $\mathbb{R} \times M$ by requiring that the standard tangent vector $(1, 0)$ at $(a, m) \in \mathbb{R} \times M$ is mapped to $(0, X(m))$. At this point we have equipped $\mathbb{R} \times M$ with an \mathbb{R} -invariant almost complex structure that couples the Reeb vector field with the \mathbb{R} -direction. We will refer to such as an almost complex structure *compatible* with λ .

It is natural to ask about the existence of holomorphic maps from Riemann surfaces with image in $\mathbb{R} \times M$ and raise the question whether the geometry of these curves reflect in some way the dynamics of X , since \tilde{J} couples the Reeb vector field with the \mathbb{R} -direction. That in fact turns out to be true and was used by the second author to prove certain cases of the Weinstein conjecture, [41]. This approach was in part motivated by Gromov's pseudoholomorphic curve theory for symplectic manifolds. However, the extension for contact manifolds is by no means straight forward, since the compactness issues for solution spaces are tricky, see [41, 10].

The Weinstein conjecture was formulated in [75] and stipulates that on a closed manifold a Reeb vector field has a periodic orbit. The first breakthrough came in [74] followed by [27]. In [42] it was shown that this conjecture can sometimes be solved if holomorphic spheres are present and this paper was the starting point of linking the Weinstein conjecture to

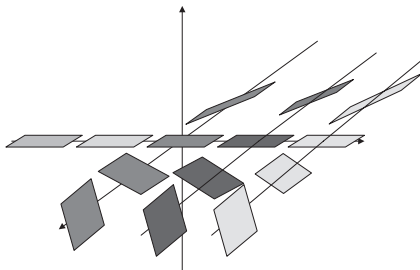

FIGURE 3. A contact structure.

Gromov-Witten theory, before it really existed, which was completed in [63]. The conjecture in dimension three was recently settled by Taubes, [73], and uses a relationship between Seiberg-Witten theory and holomorphic curve theory. The conjecture in higher dimensions is open. For example it is not known if every Reeb vector field on S^5 has a periodic orbit. The only result in higher dimensions, which proves the existence of periodic orbits for a class of Reeb vector fields on every closed manifold (which admits a Reeb vector field), is given in [2]. Let us begin with a detailed discussion of the holomorphic curve theory.

As it turns out one should study tuples $(S, j, \Gamma, \tilde{u})$ with (S, j) being a closed Riemann surface, Γ a finite set of punctures, and $\tilde{u} := (a, u) : S \setminus \Gamma \rightarrow \mathbb{R} \times M$ a smooth map with non-removable singularities at Γ satisfying the first order elliptic system

$$T\tilde{u} \circ j = \tilde{J} \circ T\tilde{u}.$$

This is a nonlinear Cauchy-Riemann-type equation. It also turns out to be useful to consider two tuples $(S, j, \Gamma, \tilde{u})$ and $(S', j', \Gamma', \tilde{u}')$ equivalent if there exists a biholomorphic map $\phi : (S, j) \rightarrow (S', j')$ with $\phi(\Gamma) = \Gamma'$ and $\tilde{u}' \circ \phi = \tilde{u}$. We denote an equivalence class by $[S, j, \Gamma, \tilde{u}]$. Note that in symplectic field theory we consider a somewhat different equivalence also incorporating the natural \mathbb{R} -action on $\mathbb{R} \times M$.

In a first step let us show that the dynamics of X can be viewed as a part of the theory. Given a solution $x : \mathbb{R} \rightarrow M$ of $\dot{x} = X(x)$ we can consider $[S^2, i, \{\infty\}, \tilde{u}]$ with $\tilde{u}(s + it) = (s, x(t))$. Here (S^2, i) is the standard Riemann sphere and $S^2 \setminus \{\infty\}$ is identified with \mathbb{C} with coordinates $s + it$. Observe that if y is another solution of $\dot{y} = X(y)$ with $y(0) = x(t_0)$, then $[S^2, i, \{\infty\}, \tilde{v}]$ with $\tilde{v}(s + it) = (s + c, y(t))$ is the same class. Indeed take $\phi(s + it) = (s + c) + i(t + t_0)$ which defines a biholomorphic map $S^2 \rightarrow S^2$ fixing ∞ . Then

$$\begin{aligned} \tilde{u} \circ \phi(s + it) &= \tilde{u}((s + c) + i(t + t_0)) = (s + c, x(t + t_0)) \\ &= (s + c, y(t)) = \tilde{v}(s + it). \end{aligned}$$

Hence

$$[S^2, i, \{\infty\}, \tilde{v}] = [S^2, i, \{\infty\}, \tilde{u}].$$

We call this particular type of class an *orbit plane*, or a *plane over a Reeb orbit*.

If an orbit x is periodic, say $x(t + T) = x(t)$, then it also gives us the class

$$[S^2, i, \{0, \infty\}, \tilde{u}]$$

where $S^2 \setminus \{0, \infty\}$ can be identified with $\mathbb{R} \times (\mathbb{R}/\mathbb{Z})$, and

$$\tilde{u}(s, [t]) = (Ts, x(Tt)).$$

We call this an *orbit cylinder*, or a *cylinder over a periodic Reeb orbit*.

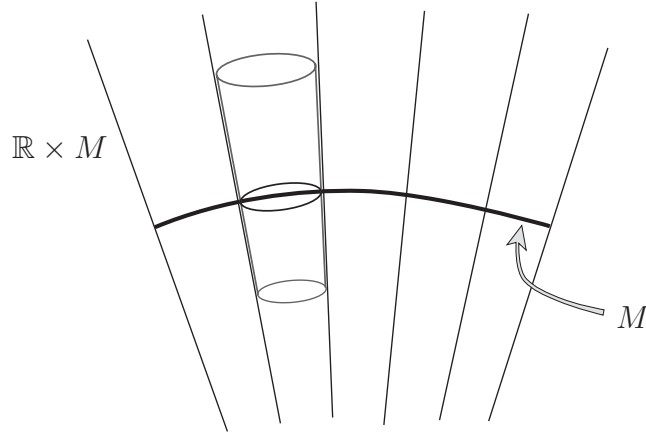

FIGURE 4. A cylinder over a periodic orbit.

That there is an interesting theory, which still has to be explored much further, comes from the fact that there are many holomorphic curves which interrelate these simple building blocks. When M is compact, these are the curves satisfying a finite energy condition.

2.2. Notions of Energy. Let us introduce two important quantities, which are certain energy measurements.

DEFINITION 2.1. Let $[S, j, \Gamma, \tilde{u}]$ be a pseudoholomorphic curve. We assume that the punctures are non-removable. Then we say it is a *finite energy curve* provided

$$E(\tilde{u}) := \sup_{\varphi} \int_{S \setminus \Gamma} \tilde{u}^* d(\varphi \lambda) < \infty.$$

Here the supremum is taken over the collection Σ of all smooth maps $\varphi : \mathbb{R} \rightarrow [0, 1]$ with $\varphi'(s) \geq 0$.

If we compute the energy E of a cylinder over a T -periodic orbit we obtain the identity

$$E = T.$$

However, for the energy of a plane over a Reeb orbit we find

$$E = \infty.$$

There is another useful energy which can be introduced.

DEFINITION 2.2. The $d\lambda$ -energy is defined by

$$E_{d\lambda}(\tilde{u}) = \int_{S \setminus \Gamma} u^* d\lambda.$$

This energy turns out to be 0 in both the previous cases. However, there are in general many interesting holomorphic curves which have a positive $d\lambda$ -energy. These are in fact the curves used to establish relations between the periodic orbits. The easiest examples are finite energy planes.

DEFINITION 2.3. A *finite energy plane* is an equivalence class $[S^2, j, \{\infty\}, \tilde{u}]$ for which ∞ is (as usual) not removable and $0 < E < \infty$.

We will see in Theorem 2.5 that finite energy planes behave very differently to the (infinite) energy planes over orbits that we just encountered. Interesting properties of finite energy planes were used in [41] to prove cases of the Weinstein conjecture, [75].

It takes some analysis to show that if $\tilde{u} = (a, u) : \mathbb{C} \rightarrow \mathbb{R} \times M$ represents a finite energy plane, then its \mathbb{R} -component a is proper. That means that $a(z) \rightarrow \infty$ for $|z| \rightarrow \infty$. Then, as a consequence of Stokes' theorem one easily verifies

LEMMA 2.4. *For a finite energy plane \tilde{u} we have the equality*

$$E(\tilde{u}) = E_{d\lambda}(\tilde{u}).$$

The finite energy planes have some nice properties. For example they detect contractible periodic orbits of the Reeb vector field.

THEOREM 2.5. *Assume that $\tilde{u} := (a, u) : \mathbb{C} \rightarrow \mathbb{R} \times M$ is smooth and satisfies the differential equation*

$$T\tilde{u} \circ i = \tilde{J} \circ T\tilde{u}.$$

Assume further that \tilde{u} is nonconstant and $E(\tilde{u}) < \infty$. Then $T := E(\tilde{u}) \in (0, \infty)$ and for every sequence $r_k \rightarrow \infty$ there exists a subsequence r_{k_j} and a solution $x : \mathbb{R} \rightarrow M$ of

$$\dot{x} = X(x) \quad \text{and} \quad x(0) = x(T)$$

so that in addition

$$\lim_{j \rightarrow \infty} u(r_{k_j} \cdot e^{2\pi i t}) = x(Tt) \quad \text{in } C^\infty(\mathbb{R}/\mathbb{Z}, M).$$

In other words, non-constant solutions on the 1-punctured Riemann sphere are related to periodic orbits for the Reeb vector field. The period in fact being the quantity

$$T = \int_{\mathbb{C}} u^* d\lambda = E_{d\lambda}(\tilde{u}).$$

The main idea in [41] was to show that for the nonlinear Cauchy-Riemann problem associated to the Reeb vector field of an overtwisted contact form there always exists a finite energy plane, showing the existence of a periodic orbit.

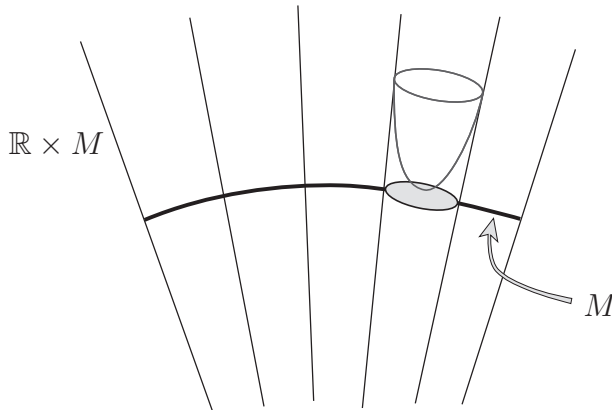

FIGURE 5. A finite energy plane asymptotic to a cylinder over a periodic orbit, and the projected disk in the contact manifold.

2.3. Global Systems of Surfaces of Section. Assume that λ is a contact form on the closed three-manifold M . Suppose we have fixed a compatible almost complex structure \tilde{J} on $\mathbb{R} \times M$ as described before. If $[S, j, \Gamma, \tilde{u}]$ is an equivalence class of solutions associated to the nonlinear Cauchy-Riemann equation, we can associate to it its *image* F defined by

$$F_{[S, j, \Gamma, \tilde{u}]} = \tilde{u}(S \setminus \Gamma).$$

This definition does not depend on the representative we have picked. We call $[S, j, \Gamma, \tilde{u}]$ an *embedded solution* provided the map

$$\tilde{u} : S \setminus \Gamma \rightarrow \mathbb{R} \times M$$

is an embedding. Let us also observe that for a given solution $[S, j, \Gamma, \tilde{u}]$ and real constant $c \in \mathbb{R}$ we obtain another solution $[S, j, \Gamma, \tilde{u}]_c$ defined by

$$[S, j, \Gamma, \tilde{u}]_c := [S, j, \Gamma, \tilde{u}_c],$$

where $(a, u)_c = (a + c, u)$ and $\tilde{u} = (a, u)$. Observe that the image of $[S, j, M, \tilde{u}]_c$ is the image of $[S, j, \Gamma, \tilde{u}]$ shifted by c via the obvious \mathbb{R} -action on $\mathbb{R} \times M$.

DEFINITION 2.6. Let λ be a contact form on the three-manifold M and \tilde{J} a compatible almost complex structure. A *finite energy foliation* $\tilde{\mathcal{F}}$ associated to this data is a smooth foliation of $\mathbb{R} \times M$ by the images of embedded curves, having finite energy, with the property that if F is a leaf, each F_c is also a leaf*.

*We will sometimes emphasize this last property by referring to a finite energy foliation as being “ \mathbb{R} -invariant”. In this article we will not consider finite energy foliations without this invariance under the \mathbb{R} -translations.

Let us observe that if we drop the requirement of finite energy we always have the following object.

DEFINITION 2.7. Let λ be a contact form on the three-manifold M . The *vertical foliation* $\tilde{\mathcal{F}}^\nu(M, \lambda)$ is defined to be the foliation of $\mathbb{R} \times M$ whose leaves take the form $\mathbb{R} \times \phi(\mathbb{R})$ over all Reeb trajectories $\phi : \mathbb{R} \rightarrow M$.

Note that the leaves of the vertical foliation are pseudoholomorphic for any almost complex structure compatible with λ , and they are invariant under \mathbb{R} -translations. However, the vertical foliation is only a finite energy foliation when every Reeb orbit is periodic. This simple observation will be crucial in Section 3.5.

Finite energy foliations, when they exist, have important consequences for the Reeb flow. Recall that a *surface of section*^{*} for a flow on a three-manifold is an embedded surface, possibly with boundary, with the property that the flow is transverse to the interior of the surface while each boundary circle is a periodic orbit, called a binding or spanning orbit. Poincaré used this notion to great effect, constructing such surfaces locally “by hand”. It was observed in [44] that a finite energy foliation gives rise to a filling of the entire three-manifold by surfaces of section, simply by projecting the leaves down via the projection map

$$\text{pr} : \mathbb{R} \times M \rightarrow M.$$

The resulting filling \mathcal{F} of the three-manifold was therefore called in [44, 45] a global system of surfaces of section, which we loosely define as follows.

DEFINITION 2.8. Let M be a three-manifold with a nowhere vanishing vector field X having a globally defined flow. A *global system of surfaces of section* for this data is a finite collection of periodic orbits \mathcal{P} of the flow, called the spanning orbits, and a smooth foliation of the complement

$$M \setminus \mathcal{P}$$

by embedded punctured Riemann surfaces \mathcal{S} , such that each leaf in \mathcal{S} converges to a spanning orbit at each of its punctures, and such that the closure of each leaf in M is a surface of section for the flow.

An adapted open book associated to a contact three-manifold [35] provides a familiar example of a global system of surfaces of section, but in contrast to the situation we describe here, one only knows *there exists* a Reeb flow making the leaves surfaces of section. A further distinction, is that in an open book all leaves lie in a single S^1 family, in particular they all have the same collection of spanning orbits.

^{*}Contrast this definition with that of a global surface of section which has the additional property that every orbit, other than the bindings or spanning orbits, hits the surface in forward and backward time.

PROPOSITION 2.9 (Hofer-Wysocki-Zehnder,[46, 45]). *Suppose that a three-manifold M equipped with a contact form λ admits an associated finite energy foliation $\tilde{\mathcal{F}}$ (with respect to some almost complex structure compatible with λ). Then the projection of the leaves down to M is a singular foliation*

$$\mathcal{F} := \{ \text{pr}(F) \mid F \in \tilde{\mathcal{F}} \}$$

with the structure of a global system of surfaces of section for the Reeb flow.

Note that in this context, where the dynamics comes from a Reeb vector field, each surface of section in \mathcal{F} comes naturally equipped with an area form of finite volume, preserved by the flow. Indeed, that the Reeb vector field is transverse to the interior of a surface $S \in \mathcal{F}$ implies that $d\lambda$ restricts to a non-degenerate 2-form on S , while the embeddedness of the leaf up to the boundary yields that the total volume, i.e. the $d\lambda$ -energy of the corresponding holomorphic curve, is finite. In fact, by Stokes theorem the area of each leaf is equal to the sum of the periods of the positive punctures minus the sum of the periods of the negative punctures.

Proposition 2.9 can be seen as follows. If F is a leaf in $\tilde{\mathcal{F}}$, then either F is a cylinder over a periodic orbit, or it is disjoint from each of its \mathbb{R} -translates, F_c , $c \neq 0$. In the former case the projection of F down to M is just the periodic orbit it spans. In the latter case, the leaf F must be nowhere tangent to $(1, 0)$ in $T(\mathbb{R} \times M)$, and since $(1, 0)$ is coupled by \tilde{J} with the Reeb vector field X , the leaf is transverse to the complex line $\mathbb{R}(1, 0) \oplus \mathbb{R}X$. This amounts to the projection of the leaf being transverse to X in M . A variety of necessary and sufficient conditions for the projection of a curve to be embedded are given in [72].

A global system of surfaces of section \mathcal{F} inherits a certain amount of other structure from the finite energy foliation $\tilde{\mathcal{F}}$. In particular, if the contact form has only non-degenerate periodic orbits, there are only two possibilities for the local behavior near each spanning orbit, depending on the parity of its Conley-Zehnder index. Local cross-sections are illustrated in Figure 6*.

For a global illustration of a global system of surfaces of section on S^3 see Figures 7 and 8, and on a solid torus see 10, 11, 12, 13.

It is not clear at all if in any given situation a finite energy foliation exists. However, it turns out, that quite often they do. The first such result appeared in [44] and was generalized further in [46]. These papers study tight Reeb flows on S^3 . According to a classification result every positive tight contact form λ on S^3 is, after a smooth change of coordinates, of the form $f\lambda_0$, where $f : S^3 \rightarrow (0, \infty)$ is a smooth map and $\lambda_0 = \frac{1}{2}[q \cdot dp - p \cdot dq]$ is the standard contact form on S^3 whose associated contact structure is the

*In general, the picture on the left of Figure 6 could happen at a spanning orbit having even parity Conley-Zehnder index if the orbit has a constraint in the form of an asymptotic “weight”. But in all the examples in this paper, there are only weights on odd index orbits so this doesn’t happen.

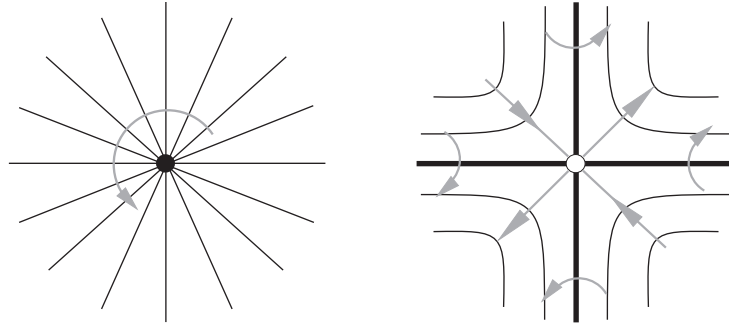

FIGURE 6. Illustrating the two forms of behavior possible in a neighborhood of a spanning orbit in a global system of surfaces of section \mathcal{F} that arises as the projection of a finite energy foliation $\tilde{\mathcal{F}}$, for a non-degenerate contact form. On the left all surfaces which enter the neighborhood converge to the spanning orbit. This occurs when the spanning orbit has odd parity Conley-Zehnder index (see also the footnote on previous page). In the second case precisely four leaves entering a neighborhood of the orbit connect to it. This occurs whenever the spanning orbit has even Conley-Zehnder index. The Reeb trajectories are transversal to the page and to the leaves in the direction of the arrows. In an open book the picture is as on the left at every spanning orbit.

line bundle of complex lines in TS^3 , where S^3 is seen as the unit sphere in \mathbb{C}^2 and $q + ip$ are the coordinates. The flow lines of X on S^3 associated to $f\lambda_0$ are conjugated to the Hamiltonian flow on the energy surface

$$N = \{\sqrt{f(z)}z \mid |z| = 1\},$$

where we indentify \mathbb{C}^2 with \mathbb{R}^4 via $q + ip \rightarrow (q_1, p_1, q_2, p_2)$, and the latter has the standard symplectic form $\omega = dq_1 \wedge dp_1 + dq_2 \wedge dp_2$. So we can formulate the results in terms of star-shaped energy surfaces in \mathbb{R}^4 , i.e. energy surfaces bounding domains which are star-shaped with respect to 0.

THEOREM 2.10 (Hofer-Wysocki-Zehnder, [44]). *Assume that N bounds a strictly convex domain containing zero and is equipped with the contact form $\lambda_0|_N$. For a generic admissible complex multiplication J on the associated contact structure there exists a finite energy foliation with precisely one leaf which is a cylinder over a periodic orbit and all other leaves are finite energy planes asymptotic to it.*

After projecting down to the 3-manifold N , each plane-like leaf gives rise to a disk-like surface of section with boundary the spanning orbit, and finite volume. The convexity implies that the generalized Conley-Zehnder

index of the spanning orbit is at least 3. This implies that the orbits nearby intersect all the leaves of the projected foliation transversally enough that all orbits, besides the spanning orbit, hit each leaf in forwards and backwards time. Thus, fixing any leaf, we obtain a well defined return map, which is an area-preserving diffeomorphism of the open disk. By an important result of Franks we obtain that the disk map, if it has at least two periodic points must have infinitely many periodic orbits. Hence we obtain the following corollary.

COROLLARY 2.11 (Hofer-Wysocki-Zehnder). *On an energy surface in \mathbb{R}^4 which bounds a strictly convex bounded domain, we have either precisely two geometrically distinct periodic orbits or infinitely many.*

We would like to emphasize that no kind of genericity is assumed.

When we go to the most general case, namely that of an energy surface bounding a starshaped domain, we in general still need some genericity

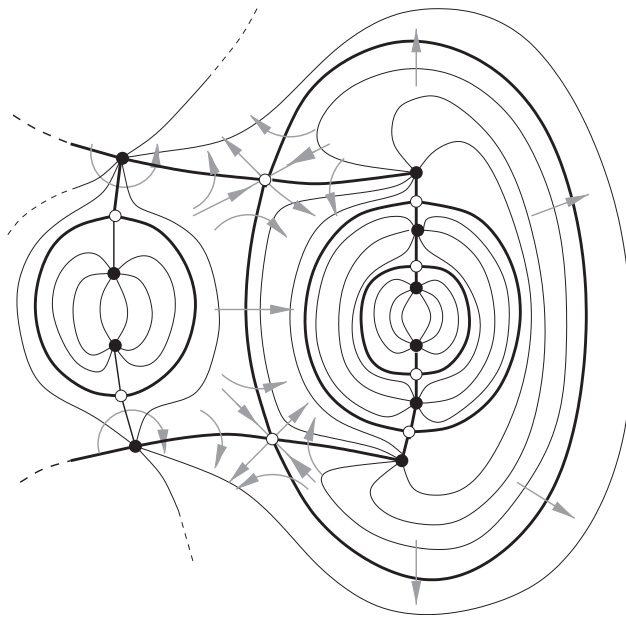

FIGURE 7. A global system of surfaces of section of S^3 , obtained as the projection of a finite energy foliation of $\mathbb{R} \times S^3$. The 3-sphere is viewed as $\mathbb{R}^3 \cup \{\infty\}$, and the figure shows the trace of the surfaces of section cut by a plane. The dots represent the spanning periodic orbits; they are perpendicular to the page and two dots belong to the same periodic orbit. The white dots represent periodic orbits of index 2 and the black dots periodic orbits of index 3. The leaves are disk-like and annuli-like. The rigid surfaces are represented by bold curves. The grey arrows indicate the Reeb flow.

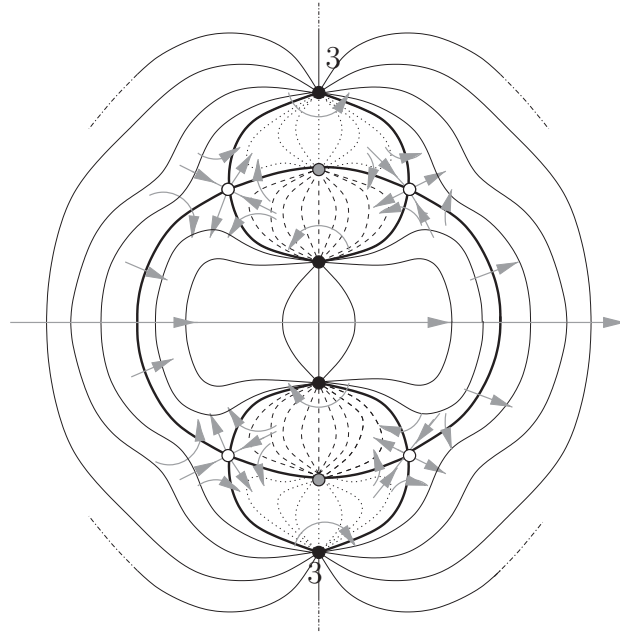

FIGURE 8. A second example, illustrating a finite energy foliation associated to S^3 . The grey dots represent a periodic orbit of index 1, the white dots periodic orbits of index 2 and the black dots periodic orbits of index 3. The leaves are again disk-like and annuli-like surfaces. The rigid surfaces are represented by bold curves. Dotted and dashed surfaces represent families of annuli-like surfaces connecting periodic orbits of index 3 with periodic orbits of index 1. Thin curves represent disk-like surfaces asymptotic to periodic orbits with index 3. The grey arrows picture the flow of the Reeb vector field.

assumption^{*}. For example assuming that all periodic orbits are non-degenerate and the stable and unstable manifolds of hyperbolic orbits are transversal where they intersect. This can always be obtained by a C^∞ -small perturbation of the energy surface. Alternatively we may consider generic contact forms $f\lambda_0$ on S^3 , so that the associated star-shaped energy surface has the previously described genericity properties.

THEOREM 2.12 (Hofer-Wysocki-Zehnder, [46]). *Let $\lambda = f\lambda_0$ be a generic contact form on S^3 . Then for a generic complex multiplication on ξ with associated \mathbb{R} -invariant almost complex structure \tilde{J} on $\mathbb{R} \times S^3$, there exists*

^{*}This is only a technical assumption and one should be able to remove it. However, it might not be so easy to draw the same conclusions about the dynamics of the Reeb vector field.

an associated finite energy foliation. Besides finitely many cylinders over periodic orbits the other leaves are parameterized by punctured finite energy spheres with precisely one positive puncture, but which can have several negative punctures. The asymptotic limits at the punctures are simply covered.

The precise result also contains some more technical information about the Conley-Zehnder indices of the periodic spanning orbits and we refer the reader to [46]. The Figures 7 and 8, taken from [45], describe some of the structure.

From this result again one can derive that there are either two or infinitely many periodic orbits, given the described genericity. We now sketch the proof of this.

If we have only one spanning orbit, then we have a *global disk-like surface of section*, meaning a surface of section, homeomorphic to the open disk, with a well defined return map, preserving a finite volume form. The assertion then follows from Franks' theorem. Assume that we have two spanning orbits. In that case we must have at least one hyperbolic spanning orbit of period T say. One can show quite easily that there exists a heteroclinic chain connecting several hyperbolic spanning orbits. Using our genericity assumption we can use symbolic dynamics to construct infinitely many periodic orbits. The heteroclinic chain follows immediately from the fact that we only have finitely many spanning orbits and that the stable and unstable manifold of a hyperbolic orbit intersect the nearby leaves of the finite energy foliation in loops which have λ -integral equal to the period T . Essentially for area reasons the assertion follows. The reader should take any of the two Figures 7 or 8 and try to carry out the argument.

In recent papers Hryniewicz and Hryniewicz-Salomoa, [47, 48, 49] have been able to give a necessary and sufficient condition for when a sphere-like energy surface possesses a global disk-like surface of section.

Recent work by Albers, Frauenfelder, van Koert and Paternain, [1] and Cieliebak, Frauenfelder and van Koert, [17] make it feasible to use finite energy foliations in the study of the classical restricted circular planar three-body problem.

Using quite different singular foliations in a symplectic setting note recent work of Pelayo and Vũ Ngọc [68, 69]. They combined symplectic and dynamical ideas to prove surprising classification results for semitoric integrable systems.

Finally let us note that finite energy foliations have important applications in contact geometry as well, see [77, 78, 79].

3. Holomorphic Curves and Disk Maps

We saw in the last section, Theorem 2.10, that finite energy foliations exist for generic Reeb flows on the tight 3-sphere. It turns out that not

just one, but many such foliations can be constructed if we replace the 3-sphere with a solid torus and restrict to generic Reeb flows which have no contractible periodic orbits.

Any area preserving diffeomorphism of the disk can be put into this framework, with different iterates giving rise to genuinely different global systems of surfaces of section. The question arises how one can profit, dynamically speaking, from this perspective. One could hope that the holomorphic curves provide a book-keeping tool for tracking the history and future of the orbits of a disk map.

As a first step in this direction, we outline how these can be used to prove the Poincaré-Birkhoff fixed point theorem, and a complementary result “Theorem” 3.20 which says that maps with two periodic orbits have some iterate which either has a “twist” or is the identity map. This latter statement might be new. Combining these one recovers, albeit currently with an additional boundary condition, a celebrated theorem of Franks [30] in the smooth category, a more recent result of Franks and Handel [32], along with sharp growth estimates on periodic orbits known to follow from results of Le Calvez [61].

These applications due to the first author depend on more recent developments [13, 14] in which it is shown how to construct finite energy foliations with a prescribed spanning orbit. See “Theorem” 3.13 for a precise statement. This is a surprising novelty, implying that in general there are many more finite energy foliations than might naively be expected. This result is labelled “theorem” as it is not completely written up. Results depending on this one are also labelled in quotation marks.

This section explains the existence statements for finite energy foliations, and outlines proofs of the mentioned dynamical applications.

3.1. Reeb-like Mapping Tori. Let $Z_\infty = \mathbb{R} \times D$ be the infinite tube equipped with coordinates $(\bar{z}, \bar{x}, \bar{y})$. There is a \mathbb{Z} -action generated by the “1-shift” automorphism $\tau(\bar{z}, \bar{x}, \bar{y}) = (\bar{z} + 1, \bar{x}, \bar{y})$. Quotienting out by some iterate τ^n gives us a solid torus Z_n of “length” n . We denote by $(z + n\mathbb{Z}, x, y)$ the induced coordinates on Z_n , and write z to mean $z + n\mathbb{Z}$ when the context is clear.

DEFINITION 3.1. For $n \in \mathbb{N}$, a *Reeb-like mapping torus* will refer to a contact form λ_n on Z_n , for which the disk slice $D_0 := \{z = 0\}$ is a global surface of section for the Reeb flow, and which lifts to a contact form λ_∞ on Z_∞ having the following properties: it is invariant under pull-back by the 1-shift automorphism, and has contact structure $\ker\{cdz + xdy - ydx\}$, some $c > 0$.

By a *global* surface of section is meant that the trajectory through any point in the solid torus passes through D_0 in forwards and backwards time, and does so transversely to D_0 . In particular, $d\lambda_n$ restricts to an area form on D_0 , and the flow induces a first return map.

From a Reeb-like mapping torus λ_n on Z_n one can lift and project to obtain a sequence of mapping tori

$$(Z_1, \lambda_1), (Z_2, \lambda_2), (Z_3, \lambda_3) \dots$$

The first return map of the flow on (Z_1, λ_1) is a diffeomorphism $\psi : D \rightarrow D$ preserving the area form $\iota^*d\lambda_1$, where $\iota : D \hookrightarrow D_0 = \{0\} \times D$ is inclusion, and the first return map on (Z_n, λ_n) is then the n -th iterate ψ^n .

In this situation, we will say that (Z_1, λ_1) *generates* the disk map ψ , and that (Z_n, λ_n) generates ψ^n .

LEMMA 3.2. *Let $\psi : D \rightarrow D$ be any orientation preserving, C^∞ -diffeomorphism preserving $dx \wedge dy$. Then there exists a Reeb-like mapping torus (Z_1, λ_1) having first return map ψ for which $\iota^*d\lambda_1 = dx \wedge dy$, the standard Euclidean volume form.*

A proof of this under the assumption that ψ restricts to a rotation on the boundary of the disk is contained in [11].

Identifying Z_n with $\mathbb{R}/n\mathbb{Z} \times D$, the product structure gives us a canonical way to assign linking numbers to pairs of homologous periodic orbits, and, along with the S^1 -symmetry of the contact structure, canonically assign Conley-Zehnder indices to individual periodic orbits. We explain this now.

There is a canonical basis of $H_1(\partial Z_n; \mathbb{Z}) \simeq \mathbb{Z} \oplus \mathbb{Z}$ we will denote by $\{L_n, [\partial D]\}$, which are the unique elements represented by closed oriented loops of the form $\mathbb{R}/n\mathbb{Z} \times \{\text{pt}\}$ and $\{\text{pt}\} \times \partial D$ respectively. We call L_n the *canonical longitude* on Z_n , and $[\partial D]$ the *canonical meridian* on Z_n . With a little elementary algebraic topology, one can show that if γ is an immersed closed loop in Z_n , disjoint from ∂Z_n , and homologous to L_n , then

$$\{L_n, [\partial D]\}$$

is also a basis for $H_1(Z_n \setminus \gamma(S^1); \mathbb{Z})$ after applying the inclusion $\partial Z_n \hookrightarrow Z_n \setminus \gamma(S^1)$. (This is not true if we replace homology groups by homotopy groups in case γ is knotted). Thus the following is well defined.

DEFINITION 3.3. Let $\gamma_1, \gamma_2 : S^1 \rightarrow Z_n$ be two continuously embedded closed loops having degree 1 after projecting onto the S^1 -factor of $Z_n = \mathbb{R}/n\mathbb{Z} \times D$. Assume that their images are disjoint from each other and from ∂Z_n . Then γ_1 determines an homology class in the complement of γ_2 . Define the *linking number* to be the unique integer $\text{lk}(\gamma_1, \gamma_2)$ such that γ_1 is homologous to

$$L_n + \text{lk}(\gamma_1, \gamma_2)[\partial D] \in H_1(Z_n \setminus \gamma_2(S^1); \mathbb{Z})$$

where $\{L_n, [\partial D]\}$ is the canonical basis, longitude and meridian, that we just defined.

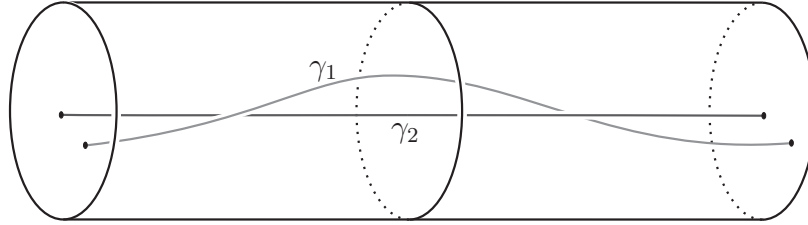

FIGURE 9. γ_1 and γ_2 represent two disjoint continuously embedded closed loops in the solid torus Z_2 . Their linking number is $\text{lk}(\gamma_1, \gamma_2) = 1$.

The linking number turns out to be symmetric, that is $\text{lk}(\gamma_1, \gamma_2) = \text{lk}(\gamma_2, \gamma_1)$. Moreover, with these conventions one has linear growth under iterates: if $\gamma_i^k : S^1 \rightarrow Z_{kn}$ represents the unique lift of γ_i to the longer mapping torus (Z_{kn}, λ_{kn}) , for $i \in \{0, 1\}$, then $\text{lk}(\gamma_1^k, \gamma_2^k) = k \cdot \text{lk}(\gamma_2, \gamma_1)$ if $k \in \mathbb{N}$.

Making use of further symmetry of the contact structure we also obtain canonical Conley-Zehnder indices for periodic orbits of the Reeb flow. Recall that usually, on a general manifold M equipped with a contact form λ , at a periodic orbit γ of the Reeb flow one requires a choice of symplectic trivialization, up to homotopy type, of the contact structure $\xi := \ker \lambda$ along γ to be able to assign a Conley-Zehnder index to γ . In the cases at hand the contact manifold Z_n is covered by $Z_\infty = \mathbb{R} \times D$ on which the contact structure $\xi := \ker \lambda_\infty$ is invariant under the \mathbb{R} -action $c \cdot (\bar{z}, \bar{x}, \bar{y}) = (\bar{z} + c, \bar{x}, \bar{y})$ (and hence also globally trivializable). This descends to a circle action $c \cdot (z, x, y) = (z + c, x, y)$ on Z_n . There is a unique homotopy class of trivializations on Z_n admitting a representative which is invariant under this circle action.

DEFINITION 3.4. Let γ be a periodic orbit of the Reeb flow of (Z_n, λ_n) . Then we take the *Conley-Zehnder index* of γ to be with respect to the unique homotopy class of global trivializations of the contact structure which admit an S^1 -invariant representative. We will denote this by

$$\mu(\gamma) \in \mathbb{Z}.$$

3.2. Notions of Rotation Number. For a more sophisticated approach to rotation numbers of surface maps see [30, 31, 32, 60], in which the area preserving property of the map is used to make sense of the rate at which *almost all* orbits rotate about a given fixed point, via the Birkhoff ergodic theorem.

For our discussion it will suffice to talk of the *total* rotation number of a smooth area preserving diffeomorphism of the disk associated to its restriction to the boundary circle and associated to a periodic point, in the latter intuitively describing the infinitesimal rate at which points nearby rotate

around the periodic orbit. By total, we mean that the rotation numbers are real valued, as opposed to merely circle valued*.

Recall that any orientation preserving homeomorphism of the circle has a well defined value in \mathbb{R}/\mathbb{Z} called its rotation number. Any choice of lift to a homeomorphism of the real line can be assigned a real valued rotation number, but this depends on the choice of lift. Similarly, any choice of homotopy of the circle map to the identity determines a unique lift and thus allows to assign a real valued rotation number. Indeed, if $F : [0, 1] \times S^1 \rightarrow S^1$, is a homotopy from $\text{id} = F(0, \cdot)$ to $f = F(1, \cdot)$, there is a unique lift $\bar{F} : [0, 1] \times \mathbb{R} \rightarrow \mathbb{R}$ of F satisfying $\bar{F}(0, \cdot) = \text{id}_{\mathbb{R}}$, giving us a canonical lift $\bar{F}(1, \cdot)$ of f .

More generally, if one has a diffeomorphism of a surface one can assign a circle valued rotation number to the restriction to any boundary component, and to each fixed point via the differential at the fixed point. But we can obtain the more useful real valued rotation numbers if the map is isotopic to the identity and we choose such an isotopy class. Moreover, this gives a canonical way to assign integer valued linking numbers to pairs of periodic orbits of the same period.

In the framework we are working with here, we are always in the situation of having a diffeomorphism of the disk for which we have chosen a mapping torus generating it as the first return map. This is similar to fixing an isotopy class from the disk map to the identity, and indeed, the choice of a mapping torus allows us to define real valued rotation numbers (and linking numbers as we already saw). Although for all of this it is unnecessary that the map be area preserving, we will nevertheless make use of this to make a short route to a workable definition.

Consider a Reeb-like mapping torus (Z_1, λ_1) generating a disk map $\psi : D \rightarrow D$. Let $f : \partial D \rightarrow \partial D$ denote the restriction of ψ to the boundary. The choice of mapping torus gives us a canonical lift $\bar{f} : \mathbb{R} \rightarrow \mathbb{R}$ of f as follows.

Restricting the Reeb-flow to the boundary of the disk slice $D_0 = \{0\} \times D \subset Z_1$, gives us a smooth map $\phi : \mathbb{R} \times \partial D_0 \rightarrow \partial Z_1$. Reparameterising if necessary, we may assume that all points in ∂D_0 have first return time 1. Then ϕ restricts to a map $\phi : [0, 1] \times \partial D_0 \rightarrow \partial Z_1$ whose projection onto the ∂D factor of $\partial Z_1 = \mathbb{R}/\mathbb{Z} \times \partial D$ gives us a homotopy

$$F : [0, 1] \times \partial D \rightarrow \partial D$$

from $F(0, \cdot) = \text{id}$ to $F(1, \cdot) = f$. As described above, F has a unique lift to a homotopy of \mathbb{R} starting at the identity and ending at a lift of f , which we take to be \bar{f} .

*What we refer to here as *total rotation numbers* are perhaps better described as *translation numbers*. The difference between this concept and *rotation number* is explained nicely in Franks [33] for example.

DEFINITION 3.5. For each $n \in \mathbb{N}$ define the *total rotation number of ψ^n on the boundary* to be the real number

$$\text{Rot}_{\psi^n}(\partial D) := \text{Rot}(\bar{\psi}_n),$$

where $\bar{\psi}_n : \mathbb{R} \rightarrow \mathbb{R}$ is the canonical lift, just described, of $\psi^n : \partial D \rightarrow \partial D$ induced by the flow on the boundary of Z_n .

It is easy to show that for each $n \in \mathbb{N}$, $\text{Rot}_{\psi^n}(\partial D) = n \text{Rot}_{\psi}(\partial D)$.

DEFINITION 3.6. Let $n \in \mathbb{N}$. For $p \in \text{Fix}(\psi^n)$ we define the *infinitesimal rotation number of ψ^n at p* to be

$$\text{Rot}_{\psi^n}(p) := \frac{1}{2} \lim_{k \rightarrow \infty} \frac{\mu(\gamma_p^k)}{k}$$

where $\gamma_p : S^1 \rightarrow Z_n$ is the periodic orbit passing through the disk slice D_0 at the point p , and $\mu(\gamma)$ denotes the Conley-Zehnder index of γ as described in 3.4.

Again, it is easy to show that for each $k \in \mathbb{N}$, $\text{Rot}_{\psi^{kn}}(p) = k \text{Rot}_{\psi^n}(p)$.

DEFINITION 3.7. Let $p \in \text{Fix}(\psi^n)$ be an interior fixed point. Define the *twist interval* of p , as a fixed point of ψ^n , to be the open interval of real numbers

$$\text{twist}_{\psi^n}(p) := \left(\min\{\text{Rot}_{\psi^n}(p), \text{Rot}_{\psi^n}(\partial D)\}, \max\{\text{Rot}_{\psi^n}(\partial D), \text{Rot}_{\psi^n}(p)\} \right).$$

This interval could be empty.

We emphasize, that all three definitions above are implicitly *with respect to a choice of data* (Z_1, λ_1) , that is, a Reeb-like mapping torus generating the disk map ψ .

3.3. Finite Energy Foliations for Mapping Tori. In our discussion here of finite energy foliations associated to Reeb-like mapping tori, as opposed to more general three-manifolds (see definition 2.6), the leaves will come in only two forms; cylinders and half cylinders.

Consider a Reeb-like mapping torus (Z_n, λ_n) . Let \tilde{J}_n be an almost complex structure on $\mathbb{R} \times Z_n$ that is compatible with λ_n in the sense described in Section 2.1.

REMARK 3.8. It is possible to do everything that follows under the additional assumption that \tilde{J}_n is the lift of an almost complex structure \tilde{J}_1 on $\mathbb{R} \times Z_1$ that is compatible with λ_1 . In other words, that the lift \tilde{J}_∞ to $\mathbb{R} \times Z_\infty$ is invariant under the 1-shift automorphism, or deck transformation, $(a, \bar{z}, \bar{x}, \bar{y}) \mapsto (a, \bar{z} + 1, \bar{x}, \bar{y})$. This is potentially a very useful symmetry, giving us positivity of intersections between leaves of foliations associated to different iterates. But we do not use this for any of the arguments or applications in this paper except for Theorem 4.1.

A *cylinder* will refer to a finite energy pseudoholomorphic curve of the form

$$[S^2, i, \{0, \infty\}, \tilde{u}],$$

so called because $S^2 \setminus \{0, \infty\}$ can be identified with $\mathbb{R} \times S^1$. In other words, a cylindrical leaf in a finite energy foliation $\tilde{\mathcal{F}}$ associated to a Reeb-like mapping torus (Z_n, λ_n) with compatible almost complex structure \tilde{J}_n , will mean the image of an embedded solution $\tilde{u} : \mathbb{R} \times S^1 \rightarrow \mathbb{R} \times Z_n$ to the non-linear Cauchy-Riemann equation, having finite E -energy.

A *half cylinder* leaf in $\tilde{\mathcal{F}}$ will refer to a finite energy pseudoholomorphic curve (with boundary) of the form

$$[D, i, \{0\}, \tilde{v}]$$

where $D = \{z \in \mathbb{C} \mid |z| \leq 1\}$, because $D \setminus \{0\}$ can be holomorphically identified with the half infinite cylinder $[0, \infty) \times S^1$. As this is our first reference to pseudoholomorphic curves with boundary, let us be more precise. Any representative of a half cylinder leaf can be identified with an embedded solution

$$\tilde{v} = (b, v) : [0, \infty) \times S^1 \rightarrow \mathbb{R} \times Z_n$$

to the differential equation $T\tilde{v} \circ i = \tilde{J}_n \circ T\tilde{v}$, having finite energy, and satisfying the following boundary condition, that there exists a constant $c \in \mathbb{R}$ such that

$$\tilde{v}(\{0\} \times S^1) \subset \{c\} \times \partial Z_n.$$

The constant c depends on the leaf. Indeed, if $F = \tilde{v}([0, \infty) \times S^1)$ is a leaf with boundary in $\{c\} \times \partial Z_n$, then translation in the \mathbb{R} -direction to $F_{c'}$ is a leaf with boundary in $\{c + c'\} \times \partial Z_n$.

For the elliptic theory to work well, a pseudoholomorphic curve with boundary is typically required to have each boundary component lie in a prescribed surface in $\mathbb{R} \times M$ having suitable properties. For example surfaces of the form $\{\text{const}\} \times L$ where λ restricts to a closed form on L , is one possibility. This is the situation we work with here, where $L = \partial Z_n$.

A finite energy foliation $\tilde{\mathcal{F}}$ associated to a Reeb-like mapping torus (Z_n, λ_n) , must have a non-empty collection of half cylinder leaves. These determine a unique element in $H_1(\partial Z; \mathbb{Z})$. That is, if $\tilde{v} = (b, v) : [0, \infty) \times S^1 \rightarrow \mathbb{R} \times Z_n$ represents a leaf, then the restriction $v(0, \cdot) : S^1 \rightarrow \partial Z_n$ is a closed loop representing an homology class that is the same for all leaves in $\tilde{\mathcal{F}}$. This homology class we will refer to as the *boundary condition* of $\tilde{\mathcal{F}}$.

We can visualize the finite energy foliations of a Reeb-like mapping torus as in Figures 10 and 11.

The boundary condition can be described more succinctly in terms of a single integer.

DEFINITION 3.9. Let $\tilde{\mathcal{F}}$ be a finite energy foliation associated to a Reeb-like mapping torus (Z_n, λ_n) . We will say that $\tilde{\mathcal{F}}$ has *boundary condition*

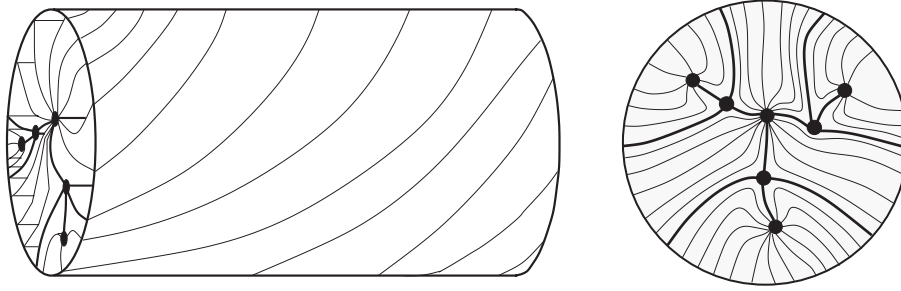

FIGURE 10. A global system of surfaces of section of a Reeb-like mapping torus. On the right a disk-like cross-section, where the spanning orbits are the dots. This can be compared with Figures 7 and 8, although here each spanning orbit corresponds to a single dot rather than a pair.

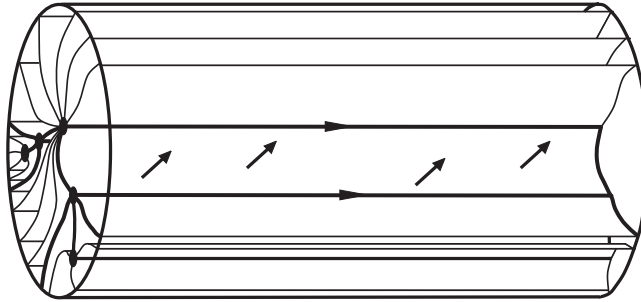

FIGURE 11. An opened out view of a global system of surfaces of section of a mapping torus. Inside, we see that the closure of each leaf is an embedded copy of $S^1 \times [0, 1]$. The flow is transversal to the interior of each leaf, and tangent to those components of the boundary which lie in the interior of the solid torus. These are the spanning orbits.

$k \in \mathbb{Z}$ if every half cylinder leaf $F \in \tilde{\mathcal{F}}$ has boundary representing the homology class

$$L_n + k[\partial D] \in H_1(\partial Z_n; \mathbb{Z})$$

where L_n and $[\partial D]$ are the canonical longitude and meridian introduced earlier.

A variety of boundary conditions are illustrated in Figure 12.

REMARK 3.10. The projected leaves from the finite energy foliations always intersect the disk-slice

$$D_0 = \{0\} \times D \in Z_1,$$

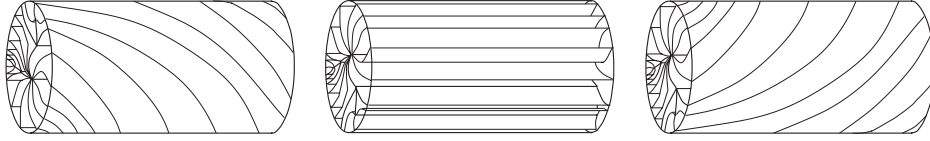

FIGURE 12. From left to right, the boundary condition is represented by the integers -1 , 0 , and 1 respectively. The winding of the leaves is measured relative to the canonical longitude $L_n \in H_1(\partial Z_n; \mathbb{Z})$.

transversally in the solid torus. Hence the nice cross-sectional pictures in the figures. We justify this now.

It is a simple matter to prescribe the almost complex structure J_1 on a neighborhood of D_0 , without losing the necessary genericity. This way one can arrange that there exists an embedded pseudoholomorphic disk $\tilde{v} : D \rightarrow \mathbb{R} \times Z_1$ with boundary $\tilde{v}(\partial D) = \{0\} \times \partial D_0 \subset \{0\} \times Z_1 \subset \mathbb{R} \times Z_1$, such that the projection of \tilde{v} to Z_1 is a parameterization of the disk slice D_0 . By taking \mathbb{R} -translates of \tilde{v} we foliate the whole hypersurface $\mathbb{R} \times D_0 \subset \mathbb{R} \times Z_1$ by a 1-parameter family of embedded holomorphic disks \mathcal{D} .

Let $\tilde{F} \in \tilde{\mathcal{F}}$ be a leaf in a finite energy foliation. Let $F = \text{pr}(\tilde{F})$ denote the projection down to Z_1 . We claim that F is transverse to D_0 . Indeed, \tilde{F} has topological intersection number 1 with each leaf in \mathcal{D} , so by positivity of intersections must also intersect each such leaf transversally in $\mathbb{R} \times Z_1$ and at a unique point. The upshot is that \tilde{F} intersects the hypersurface $\mathbb{R} \times D_0$ transversally in $\mathbb{R} \times Z_1$, and so the projection $F = \text{pr}(\tilde{F}) \subset Z_1$ intersects D_0 transversally in Z_1 . So $F \cap D_0$ is in each case a connected, compact, non-empty, zero or 1-dimensional embedded submanifold of D_0 .

The following was proven in [11].

THEOREM 3.11 (Bramham). *Let (Z_1, λ_1) be a Reeb-like mapping torus generating a non-degenerate disk map ψ , which coincides with an irrational rotation on the boundary of D . Let $\beta \in \mathbb{R}$ denote the total rotation number of ψ on the boundary, as determined by the mapping torus. For each $n \in \mathbb{N}$ let $k_n, k_n + 1$ be the two closest integers to $n\beta$. Then there exists an almost complex structure \tilde{J}_1 compatible with λ_1 , such that for each $n \in \mathbb{N}$, there exist two finite energy foliations, we will denote by $\tilde{\mathcal{F}}_n^{k_n}$ and $\tilde{\mathcal{F}}_n^{k_n+1}$, associated to $(Z_n, \lambda_n, \tilde{J}_n)$, where \tilde{J}_n is the lift of \tilde{J}_1 , which have the following properties:*

- (1) **Spanning orbits:** *They share a unique spanning orbit. That is, $|\mathcal{P}(\tilde{\mathcal{F}}_n^{k_n}) \cap \mathcal{P}(\tilde{\mathcal{F}}_n^{k_n+1})| = 1$. The shared orbit has odd Conley-Zehnder index $2k_n + 1$.*
- (2) **Boundary conditions:** *The boundary condition for the leaves in $\tilde{\mathcal{F}}_n^j$, for $j \in \{k_n, k_n + 1\}$, is precisely the integer j .*

The following is a basic observation.

LEMMA 3.12. *Any two distinct spanning orbits γ_1, γ_2 of a finite energy foliation $\tilde{\mathcal{F}}$ have linking number $\text{lk}(\gamma_1, \gamma_2) = k$ where k is the integer representing the boundary condition of $\tilde{\mathcal{F}}$.*

The next existence result is far more useful, although it already assumes the existence of a periodic orbit. For the following, note that the orbit γ having odd Conley-Zehnder index, is equivalent to a fixed point of the iterate ψ^n that is either elliptic, or is hyperbolic with unorientable stable and unstable manifolds.

“THEOREM” 3.13 (Bramham). *Let (Z_1, λ_1) be a Reeb-like mapping torus generating a non-degenerate disk map ψ , which coincides with an irrational rotation on the boundary of D^* . Then there exists an almost complex structure \tilde{J}_1 compatible with λ_1 , such that for each $n \in \mathbb{N}$, the data $(Z_n, \lambda_n, \tilde{J}_n)$ admits “many” finite energy foliations, where \tilde{J}_n is the lift of \tilde{J}_1 : Let γ be any periodic orbit in (Z_n, λ_n) homologous to the longitude L_n , and having odd parity Conley-Zehnder index. Then for each $k \in \mathbb{Z}$, there exists a finite energy foliation $\tilde{\mathcal{F}}^k(\gamma)$ associated to $(Z_n, \lambda_n, \tilde{J}_n)$ with the following two properties.*

- (1) **Spanning orbits:** γ is a spanning orbit. Equivalently $\mathbb{R} \times \gamma$ is a leaf.
- (2) **Boundary conditions:** The boundary condition for the leaves in $\tilde{\mathcal{F}}^k(\gamma)$ is the chosen integer k .

The strength of this statement is that it allows to choose a spanning orbit. Additional subtleties enter the proof when the boundary condition $k \in \mathbb{Z}$ lies in the twist interval of the pre-selected periodic orbit γ , which will appear in [14]. In this case it seems that the only way around certain difficulties is to use a refinement of contact homology developed by Momin [65, 66]. The simpler boundary conditions will be covered in [13].

Here is a simple way to see that Theorem 3.13 really does produce many different finite energy foliations, even with the same boundary conditions, provided there exist enough periodic orbits. Suppose that γ_1 and γ_2 are two distinct periodic orbits in (Z_n, λ_n) that are homologous to the longitude L_n . They have a linking number $\text{lk}(\gamma_1, \gamma_2) \in \mathbb{Z}$. Now, by Lemma 3.12, for any integer $k \in \mathbb{Z}$ not equal to $\text{lk}(\gamma_1, \gamma_2)$, any finite energy foliation associated to (Z_n, λ_n) that contains γ_1 as a spanning orbit cannot contain γ_2 , unless the boundary condition is equal to $\text{lk}(\gamma_1, \gamma_2)$. Thus if $\tilde{\mathcal{F}}^k(\gamma_1)$ and $\tilde{\mathcal{F}}^k(\gamma_2)$ are finite energy foliations with boundary condition $k \in \mathbb{Z}$ where k is not equal to $\text{lk}(\gamma_1, \gamma_2)$, and having γ_1 and γ_2 as spanning orbits respectively, then $\tilde{\mathcal{F}}^k(\gamma_1) \neq \tilde{\mathcal{F}}^k(\gamma_2)$.

The discussion of integrable disk maps in Section 4.1 makes it clear in certain situations what kinds of different finite energy foliations one can

*Added in proof: all boundary assumptions in this result, and hence in all the applications here now appear to be unnecessary.

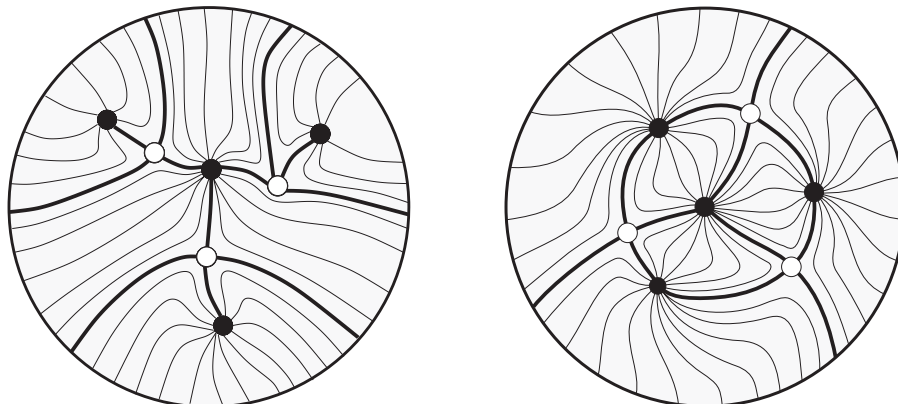

FIGURE 13. On the left a *simple* finite energy foliation. On the right the center spanning orbit is not connected directly to the boundary of the mapping torus by any leaf, so this example is not simple.

expect to find. For example, a finite energy foliation for a given (Z_n, λ_n) is in general not uniquely determined by its boundary condition and a single spanning orbit alone.

For the proofs in the next section it seems useful to distinguish the following feature for finite energy foliations of a Reeb-like mapping torus.

DEFINITION 3.14. Suppose that $\tilde{\mathcal{F}}$ is a finite energy foliation associated to a Reeb-like mapping torus on Z_n . We will say that $\tilde{\mathcal{F}}$ is *simple* if every spanning orbit is connected directly to the boundary of Z_n by a leaf in $\tilde{\mathcal{F}}$.

The following are equivalent characterizations of simple:

- The projection down to Z_n of the rigid leaves intersects the disk slice D_0 in a tree-like graph. Refer also to remark 3.10.
- There are no closed “cycles” of leaves.
- There are no Fredholm index-2 whole cylinders.

Perhaps the simplest example of a situation where one finds a non-simple finite energy foliation is the following.

Figure 14 depicts the flow lines of some autonomous smooth Hamiltonian $H : A \rightarrow \mathbb{R}$ on the closed annulus $A = \mathbb{R}/\mathbb{Z} \times [0, 1]$. The time- T map of the flow, for $T > 0$, is an area preserving twist map ϕ in the sense of Poincaré and Birkhoff. In fact for $T > 0$ sufficiently small ϕ is a monotone twist map, meaning that $\phi = (\phi_1, \phi_2) : A \rightarrow A$ where $\frac{\partial \phi_1}{\partial x_2} > 0$ in coordinates (x_1, x_2) .

Let us now consider the disk map $\psi : \tilde{D} \rightarrow D$ which one obtains by shrinking the inner circle to a point, which then corresponds to an elliptic fixed point of ψ at the origin. Let (Z_1, λ_1) be a Reeb-like mapping torus generating ψ , chosen so that the induced total rotation number on the boundary lies in the interval $(0, 1)$. Let us denote by γ_0 the periodic orbit corresponding to the fixed point $0 \in D$. Then a finite energy foliation $\tilde{\mathcal{F}}$ associated

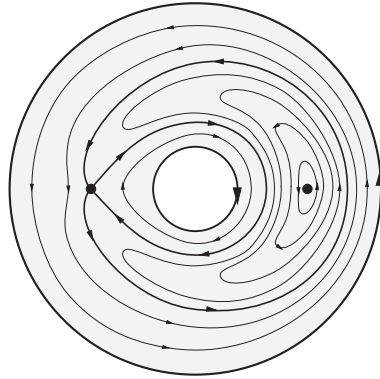

FIGURE 14

to (Z_1, λ_1) that has γ_0 as a spanning orbit, and has boundary condition 0, would, it turns out, have to look as in Figure 15, which is a non-simple foliation.

The property of $\tilde{\mathcal{F}}$ having a chain of rigid leaves surrounding the spanning orbit γ_0 and the “twisting” property going on about the fixed point 0 relative to the boundary behavior, are not coincidental. In the following precise sense there is a twist fixed point if and only if there is a non-simple finite energy foliation.

LEMMA 3.15. *Suppose that $\tilde{\mathcal{F}}$ is a finite energy foliation associated to a Reeb-like mapping torus (Z_n, λ_n) . Let $k \in \mathbb{Z}$ be the boundary condition for $\tilde{\mathcal{F}}$. Then:*

- (1) *If there exists a spanning orbit that is not connected directly to the boundary of Z_n by a leaf in $\tilde{\mathcal{F}}$ (i.e. if $\tilde{\mathcal{F}}$ is not simple), then there*

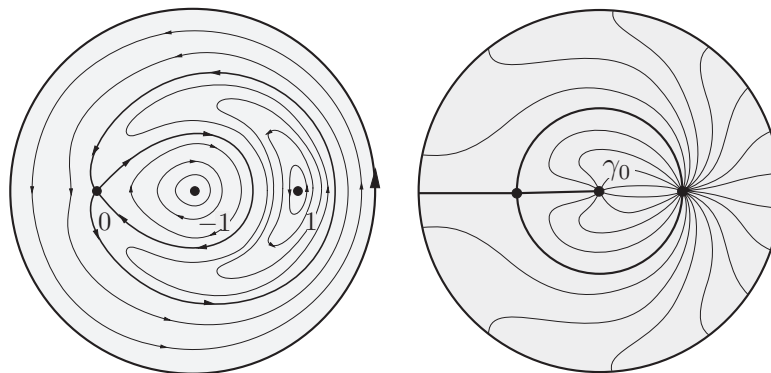

FIGURE 15. In a simple example. On the left the dynamics, with Conley-Zehnder indices, on the right one of the corresponding finite energy foliations.

exists a spanning orbit, not necessarily the same one, having $k \in \mathbb{Z}$ in its twist interval.

- (2) Every spanning orbit in $\tilde{\mathcal{F}}$ that is connected directly to the boundary of Z_n by at least one leaf, corresponds to a fixed point of ψ^n that does not have $k \in \mathbb{Z}$ in its twist interval. In particular, this implies the converse to (1).

PROOF. (Of part (2) by pictures) Suppose that there exists a spanning orbit γ which has k in its twist interval. We will argue there cannot be a leaf in $\tilde{\mathcal{F}}$ which connects γ directly to the boundary of Z .

Due to the twist, the infinitesimal rotation number of γ lies on the opposite side of the value k to the rotation number describing the boundary behavior. The behavior of the leaves and the flow near γ and near the boundary are as in the figure.

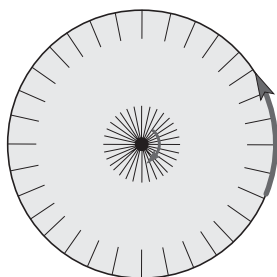

There is no way to complete the picture by connecting a leaf from the spanning orbit γ to the boundary without contradicting the transversality of the flow to the leaf; near the spanning orbit the flow winds around slower than the leaves, while the flow winds faster than the leaves near the boundary. ■

The example in Figure 15 is just a special case of the integrable maps which are discussed in generality in Section 4.1.

3.4. A Proof of the Poincaré-Birkhoff Fixed Point Theorem.

In 1913 Birkhoff in [8] proved the following conjecture of Poincaré* known as the Poincaré-Birkhoff fixed point theorem. See also [9]. Here A denotes the closed annulus $\mathbb{R}/\mathbb{Z} \times [0, 1]$ and \tilde{A} the universal covering $\mathbb{R} \times [0, 1]$ with respect to the projection map $\pi(x, y) = ([x], y)$.

THEOREM 3.16 (Birkhoff). *Let $\psi : A \rightarrow A$ be an area preserving, orientation preserving, homeomorphism of the closed annulus with the following “twist” condition. There exists a lift $\tilde{\psi} = (\tilde{\psi}_1, \tilde{\psi}_2) : \tilde{A} \rightarrow \tilde{A}$ such that for all $x \in \mathbb{R}$,*

$$\tilde{\psi}_1(x, 0) > x \quad \text{and} \quad \tilde{\psi}_1(x, 1) < x.$$

Then ψ has at least two fixed points which also lift to fixed points of $\tilde{\psi}$.

*Allegedly the effort cost Birkhoff 30 pounds in weight [5].

In our framework we consider a smooth disk map $\psi : D \rightarrow D$ represented as the first return map of a Reeb-like mapping torus (Z_1, λ_1) . We observed in Section 3.2 that the choice of a mapping torus allows us to assign canonical twist intervals to each fixed point of ψ , and an integer to pairs of distinct fixed points, called the linking number. Recall that the twist interval of ψ at a fixed point p was defined as the open interval of real numbers bounded by the (real valued) rotation number of ψ on the boundary of D and the (real valued) infinitesimal rotation number of ψ at p .

We will prove the following reformulation of Theorem 3.16.

THEOREM 3.17. *Suppose that $\psi : D \rightarrow D$ is a C^∞ -smooth orientation preserving, area preserving, diffeomorphism. Let (Z_1, λ_1) be a Reeb-like mapping torus generating ψ . If ψ has an interior fixed point $p \in D$, for which there exists an integer $k \in \mathbb{Z}$ such that*

$$k \in \text{twist}_\psi(p),$$

then ψ has at least two fixed points x_1, x_2 , distinct from p , such that the corresponding periodic orbits $\gamma_1, \gamma_2 : S^1 \rightarrow Z_1$ have linking numbers $\text{lk}(\gamma_1, \gamma_p) = \text{lk}(\gamma_2, \gamma_p) = k$. (In fact one also finds that $\text{lk}(\gamma_1, \gamma_2) = k$.)

The Poincaré-Birkhoff theorem, also in more general formulations than the statement in Theorem 3.16, has a long and beautiful history. We mention just a few references [16, 19, 20, 21, 28, 29, 37, 38, 52, 62, 67, 70]. It is perhaps not surprising that a variational approach in the spirit of Floer or Conley and Zehnder should produce a proof in the smooth category. Indeed we recall that this statement led Arnol'd to make his famous conjecture.

Nevertheless, we present now a proof by the first author of Theorem 3.17 using finite energy foliations, which is vaguely reminiscent of the simple argument that applies only to monotone twist maps. The existence of a *second* fixed point arises in a surprising way^{*}, and not by using indices of fixed points.

PROOF. (Of Theorem 3.17) We wish to apply Theorem 3.13 which gives us the existence of certain finite energy foliations. Currently to use this result requires that the behavior of the disk map be a rigid (irrational) rotation on the boundary circle. So we first make an elementary argument to reduce the general case to this one. The reader who wishes to skip this should jump to step 1.

We are given a C^∞ -smooth orientation preserving, area preserving, diffeomorphism $\psi : D \rightarrow D$ with an interior fixed point p , and an integer k lying in the twist interval of p . Observe that on any ε -neighborhood of the boundary of D we can modify ψ to obtain a new map ψ' with the following

^{*}We later learned that there is some similarity in this part of the argument with that of Cotton-Clay [20] in his proof of a generalization of the Poincaré-Birkhoff theorem that uses symplectic Floer homology.

properties. ψ' agrees with ψ outside of the boundary strip, is a rigid rotation on the boundary of D , and is still a C^∞ -smooth orientation preserving, area preserving, diffeomorphism. For example by composing ψ with a suitable Hamiltonian diffeomorphism for a Hamiltonian that is constant outside of the ε -neighborhood of ∂D . Moreover, one can do this in such a way that on the open ε -neighborhood ψ' sends points around in one direction further, in an angular sense, than ψ does, and “speeding up” as you approach the boundary circle. Pick this direction so as to enlarge the twist interval. If one does this for $\varepsilon > 0$ sufficiently small, one can arrange that ψ' has the property that any fixed points within the ε -neighborhood of the boundary have linking number with p different from k . To say all this rigorously one should of course work with a lift, on the complement of p , to the universal covering, but the idea is simple. Thus, it suffices to prove the assertion for this modified map ψ' , because the two fixed points we find will automatically be fixed points of the unmodified map ψ .

Similarly, to apply the existence Theorem 3.13 it will be convenient to assume that the fixed point p is elliptic. A similar argument to the one just described allows to modify the disk map ψ on an ε -punctured-neighborhood of the fixed point p , this time so as to send points around p faster in the opposite direction, in an angular sense, increasing the twist interval still further. This way we can arrange that for the new map the eigenvalues of the linearization $D\psi'(p)$ lie on the unit circle, so that p is elliptic. The upshot is that without loss of generality we can assume that our disk map is a rigid rotation on the boundary of the disk (with any rotation number, in particular we may take it to be irrational), and that the fixed point p is elliptic. For the rest of the argument we will make these assumptions on ψ .

Pick a Reeb-like mapping torus (Z_1, λ_1) generating the disk map ψ . Let $\gamma_p : S^1 \rightarrow Z_1$ be the simply covered periodic orbit corresponding to the fixed point p . Since p is elliptic, γ_p has odd parity Conley-Zehnder index.

Step 1 The non-degenerate case: If the disk map, equivalently the Reeb flow, is non-degenerate, then the existence Theorem 3.13 applies immediately and provides a finite energy foliation $\tilde{\mathcal{F}}$ associated to (Z_1, λ_1) which has the odd index orbit γ_p for a spanning orbit, and has boundary condition the integer k .

By part (2) of Lemma 3.15 γ_p cannot be connected to the boundary of Z_1 by a leaf in $\tilde{\mathcal{F}}$ because $k \in \text{twist}_\psi(p)$. Thus γ_p is “enclosed” by a chain of rigid leaves, as for example in Figure 16.

Note that the chain of rigid leaves has to include at least two spanning orbits, else the enclosed region has the property that points move in only one direction normal to its boundary, which would contradict the area preserving property of ψ .

Any two spanning orbits besides γ_p have linking number k with γ_p because this is the boundary condition for the foliation $\tilde{\mathcal{F}}$. Thus the theorem is proven provided ψ is non-degenerate.

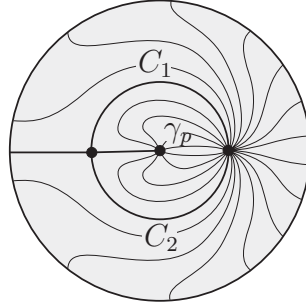

FIGURE 16. A chain of rigid leaves C_1 and C_2 enclosing γ_p .

Step 2 It is not immediately obvious how to complete the proof to the degenerate case while retaining *two* new fixed points. This part really uses compactness of the holomorphic curves, and not merely positivity of intersections.

Suppose ψ has possibly degenerate fixed points. Carrying out the above argument for a sequence of non-degenerate perturbations of ψ , keeping p fixed, we obtain a sequence of finite energy foliations $\{\tilde{\mathcal{F}}_j\}_{j \in \mathbb{N}}$ having γ_p as a spanning orbit and boundary condition k . By the argument in step 1 each $\tilde{\mathcal{F}}_j$ has at least two spanning orbits besides γ_p . These have uniformly bounded period, so as j goes to infinity they must converge to periodic orbits for the unperturbed mapping torus (Z_1, λ_1) that correspond to fixed points for ψ . The only concern is that all the spanning orbits might collapse onto a single limiting orbit, when the theorem requires two.

We argue as follows. Figure 17 illustrates the key idea. Suppose that indeed all spanning orbits from the sequence $\tilde{\mathcal{F}}_j$, besides γ_p , converge to a single periodic orbit σ in the limit as $j \rightarrow \infty$. Note first that the twist condition prevents σ from coinciding with γ_p . Indeed, the sequence of binding orbits which converge to σ have linking number k with γ_p , and this prevents them entering a small neighborhood of γ_p on which all points rotate either much faster or much slower than k depending on the direction of the infinitesimal twisting at p . So $\sigma \neq \gamma_p$.

For each j there exists a closed cycle of rigid leaves in $\tilde{\mathcal{F}}_j$, surrounding γ_p . Let S_j denote the intersection of such a closed cycle with the disk slice D_0 . Each S_j is a continuously embedded closed loop in D_0 , see remark 3.10. In particular each is non-empty, compact and connected. Taking a subsequence, we may assume that the sequence of sets S_j converges in the Hausdorff metric sense, to a non-empty compact set $S_\infty \subset D$. Each S_j is connected implies that S_∞ is connected. (Although the path connectedness need not pass to the limit.) Moreover, if S_∞ is disjoint from p and from ∂D , it is not hard to see that p and ∂D must both lie in different components of $D \setminus S_\infty$. We will establish that $S_\infty \cap (\{p\} \cup \partial D) = \emptyset$ in a moment.

As $j \rightarrow \infty$ the spanning orbits corresponding to fixed points in S_j converge to σ . This means that all their periods converge to that of σ . Which

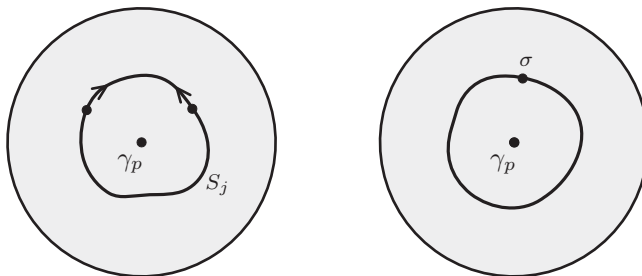

FIGURE 17. Illustrating the worst case scenario when the only two spanning orbits, besides the twist orbit γ_p , collapse onto a single orbit σ when taking a limit of a sequence of non-degenerate perturbations.

means, by Stokes' theorem, that the $d\lambda_j$ -energy of the leaves in the S_j cycles converge uniformly to zero as $j \rightarrow \infty$. Thus if $F_j \in \tilde{\mathcal{F}}_j$ is any sequence of leaves for which the projection $\text{pr}(F_j)$ meets D_0 in a point in S_j , then any convergent subsequence gives in the limit a pseudoholomorphic whole cylinder C having zero $d\lambda$ -energy, and finite E -energy. Such a solution C is either constant or is a spanning cylinder for a periodic orbit (even though the periodic orbits are not necessarily non-degenerate). From the homology class of C we find that it is non-constant, and moreover that its spanning orbit corresponds to a fixed point of ψ .

Applying this idea to various \mathbb{R} -translates of such leaves $F_j \in S_j$, we can achieve every point in the set S_∞ as such a limiting fixed point. It follows that every point $q \in S_\infty$ is a fixed point of ψ and satisfies the following two alternatives: either $q = p$, or if $q \neq p$ then it must have linking number k with p . The twist condition implies that on a small punctured neighborhood of p there are no fixed points having this linking number k with p , and so S_∞ is disjoint from some punctured neighborhood of p . Moreover, S_∞ contains at least one point distinct from p because it contains the periodic orbit σ . It follows, since S_∞ is connected, that it is also disjoint from p . Similar arguments show that S_∞ is disjoint from the boundary of D .

Thus, as mentioned above, since p and ∂D are disjoint from S_∞ , they lie in different components of the complement $D \setminus S_\infty$. The set S_∞ must therefore have infinitely many points. In particular at least two points. These are fixed points with the desired linking number k . ■

3.5. A Proof of a Theorem of Franks and Handel. We could summarize the last section by saying loosely that if an area preserving disk map has “twisting” in a suitable sense, then one can find periodic orbits and distinguish them by topological means, namely by their linking numbers.

To make this precise, let us say that a diffeomorphism $\psi : D \rightarrow D$ has “twisting” if, after making a choice that allows to define real valued rotation numbers, for example an isotopy to the identity, or a generating mapping

torus, there exists an interior fixed point $z \in D$ such that

$$(1) \quad \text{Rot}_\psi(z) \neq \text{Rot}_\psi(\partial D),$$

where the left hand side is the total infinitesimal rotation number of ψ at z , and the right hand side is the total rotation number of ψ on the boundary of D . One way to define these is described in Section 3.2, both real valued numbers.

An equivalent way of saying this is that the twist interval of the fixed point z is non-empty. The twist interval grows linearly with iterates, so that for a high enough iterate it contains an integer,

$$\text{twist}_{\psi^n}(z) \cap \mathbb{Z} \neq \emptyset.$$

In this situation the Poincaré-Birkhoff fixed point theorem, as stated in Theorem 3.17, applies to ψ^n and we find that for each integer $k \in \text{twist}_{\psi^n}(z)$, there exists a fixed point $x \in \text{Fix}(\psi^n)$ (actually two fixed points) which has linking number k with z , $\text{lk}_{\psi^n}(x, z) = k$.

It is a simple matter to work with an unbounded sequence of iterates ψ^{n_j} , and pick integers k_j in the twist interval $\text{twist}_{\psi^{n_j}}(z)$ to be primes, and so obtain a sequence of fixed points x_j for which the average linking numbers with z ,

$$\frac{\text{lk}_{\psi^{n_j}}(x_j, z)}{n_j} = \frac{k_j}{n_j},$$

are already in lowest form as fractions and are therefore pairwise distinct. Thus the sequence $(x_j)_j \in \mathbb{N}$ is a sequence of periodic points of ψ , lying on pairwise distinct orbits. Moreover, x_j has minimal period n_j , with $n_j \rightarrow \infty$ as $j \rightarrow \infty$. Thus, a disk map having a twist, or some iterate with a twist, has infinitely many periodic orbits, and moreover periodic orbits of unbounded minimal period.

In [67] the argument is pushed as far as possible. If ψ has a fixed point with non-empty twist interval (a, b) , $a, b \in \mathbb{R}$, then for each $N \in \mathbb{N}$, the number $\mu_\psi(N)$ of periodic orbits of ψ having minimal period less than or equal to N grows like $|b - a|N^2$. Indeed, for each rational number $p/q \in \mathbb{Q}$ in (a, b) the argument above gives us a periodic point of ψ having average linking number p/q . So $\mu_\psi(N)$ is at least the number of rationals in (a, b) having denominator at most N when written in lowest form. This is equivalent to counting lattice points in a triangle, having relatively prime coordinates,

$$\mu_\psi(N) \geq |\{(p, q) \in \mathbb{Z} \times \mathbb{Z} \mid Na < p < Nb, 1 \leq q \leq N \text{ and } \gcd(p, q) = 1\}|.$$

A little number theory, see [67, 40], tells us precisely what the limit of the quotient of the right hand side with N^2 is, leading to the following asymptotic estimate from below

$$(2) \quad \lim_{N \rightarrow \infty} \frac{\mu_\psi(N)}{N^2} \geq \frac{3|b - a|}{\pi^2}.$$

To summarize: a disk map with a twist has at least quadratic growth of periodic orbits. Although one might generically expect a far higher growth rate, quadratic is the best possible for general twist maps, see examples in [67].

Birkhoff himself applied these ideas to the problem of finding infinitely many closed geodesics on 2-spheres. In many cases he showed that the dynamics can be related to that of an area preserving diffeomorphism of an annulus, possibly without boundary. This holds for example whenever the metric has everywhere positive curvature. When the so called Birkhoff map has a twist he could apply his fixed point theorem as above to complete the argument.

But in the absence of a twist the problem of detecting infinitely many periodic orbits becomes much subtler. Indeed, a twist allows to conclude periodic orbits of unbounded period and to detect them by topological means. But this clearly does not work for example on the identity map of the disk which has infinitely many periodic orbits but which are indistinguishable by linking numbers. It was an open problem for some time, whether every smooth Riemannian metric on S^2 admits infinitely many distinct (prime) closed geodesics.

In 1992 John Franks proved the following celebrated result, [30] originally stated for annulus maps.

THEOREM 3.18 (Franks). *Let ψ be any area preserving, orientation preserving, homeomorphism of the open or closed unit disk in the plane. If ψ has 2 fixed points then it has infinitely many interior periodic orbits.*

A remarkable aspect of this statement is that no twisting type of condition is required. Let us point out that by imposing seemingly mild extra assumptions one can unwittingly introduce a twist into the system, thereby allowing much simpler arguments which miss the whole point of this theorem. Two examples which fall into this category, the first of which is a familiar one for symplectic geometers, are the assumption of non-degeneracy of periodic orbits, or that the rotation number on the boundary of the disk is irrational.

Franks' theorem completed the proof of the conjecture regarding closed geodesics on the two-sphere, in the cases where Birkhoff's annulus map is well defined. At the same time Bangert found a clever way to handle the cases where the Birkhoff map is not defined, [4]. Let us also note that shortly thereafter Hingston found another route to the closed geodesics question, using equivariant Morse homology [40], bypassing the part of the argument that required Theorem 3.18.*

An interesting strengthening of Franks' theorem is the following result due to Franks and Handel [32] in 2003. In fact much more generally, they

*Added in proof: recently a proof of the S^2 -version of Theorem 3.18, in the smooth category, using Floer homology, has been announced by Collier, Kerman, Reiniger, Turmunkh, and Zimmer [18].

proved analogous statements for Hamiltonian diffeomorphisms on general closed oriented surfaces.

We would also like to mention that the Franks-Handel result was extended to the C^0 -case by Le Calvez [59] using very different techniques. Indeed the approach taken by Le Calvez involved a surprising generalization of the Brouwer plane translation theorem [57, 58]. Given a surface homeomorphism isotopic to the identity (not assumed to be area preserving), he constructs a 1-dimensional foliation of the surface that in a certain sense is transverse to the dynamics. It is striking that he achieves this without any recourse to PDE's, or variational principle. Le Calvez' theory is also nicely outlined in the survey [60].

THEOREM 3.19 (Franks-Handel). *For a C^∞ -smooth Hamiltonian diffeomorphism $\psi : S^2 \rightarrow S^2$ having at least three fixed points, either there is no bound on the minimal period of its periodic orbits, or ψ is the identity map.*

In the case when the map is not the identity, they obtain in [32] the following lower bound on the growth rate of periodic orbits. There exists a constant $c > 0$, depending on ψ , such that the number of periodic orbits $\mu_\psi(N)$ with period less than or equal to $N \in \mathbb{N}$ satisfies

$$\mu_\psi(N) \geq cN$$

for all $N \in \mathbb{N}$. A significant improvement on this growth rate estimate follows from work by Le Calvez [61]. The main result in [61] can be combined with the Franks-Handel theorem or [59], to conclude at least quadratic growth of periodic orbits. Namely, that there exists $c > 0$ such that $\mu_\psi(N) \geq cN^2$ for all $N \in \mathbb{N}$.

Since this is exactly the growth rate well known for twist maps, described in (2) above, it raises the following question:

Suppose that ψ is an area preserving, orientation preserving, diffeomorphism of the disk with at least two fixed points. If ψ is not the identity, is some iterate of it actually a twist map?

Recall that we said that a disk map ψ is a *twist map* if it has the following property: that there exists an interior fixed point $p \in D \setminus \partial D$ of ψ , such that the annulus map

$$\psi : D \setminus \{p\} \rightarrow D \setminus \{p\}$$

has a twist in the following sense. Namely, that it admits a lift to a map on the infinite strip $F = (F_1, F_2) : \mathbb{R} \times (0, 1] \rightarrow \mathbb{R} \times (0, 1]$ satisfying the Poincaré-Birkhoff-like twist condition that the component F_1 is uniformly strictly positive on a neighborhood of the line $\mathbb{R} \times \{0\}$, and strictly negative on $\mathbb{R} \times \{1\}$ (or vice versa). Alternatively the twist interval of p , as in definition 3.7, contains an integer. Note that the question only asks for some *iterate* to be a twist map. As far as the authors are aware, the following is new.

“THEOREM” 3.20 (Bramham). *Let $\psi : D \rightarrow D$ be a C^∞ -smooth, area preserving, orientation preserving, diffeomorphism having at least two fixed points, and coinciding with a rigid rotation on the boundary of the disk^{*}. Then either ψ is the identity map, or there exists $n \in \mathbb{N}$ for which ψ^n is a twist map in the sense just described above.*

The quotation marks are because it relies on the unpublished “Theorem” 3.13.

Notice that this statement combined with the Poincaré-Birkhoff fixed point theorem gives us the analogous result of Franks and Handel, Theorem 3.19, but for disk maps instead of maps on S^2 . By the discussion above it also implies the sharp quadratic growth lower bound on periodic orbits. Moreover, it allows to partition the set of area preserving diffeomorphisms of the disk into the following three disjoint subsets:

- (1) **Pseudo-rotations:** those maps with a single periodic orbit.
- (2) **Roots of unity:** those maps for which some iterate is the identity.
- (3) **Twist maps:** those maps for which some iterate has an interior fixed point on whose complement we have the “twist” behavior just described above.

The following proof will appear in [12].

PROOF. (Of Theorem 3.20) Suppose that ψ has two fixed points, and that for all $n \in \mathbb{N}$, ψ^n has no twisting. In other words, every interior fixed point, of every iterate, has empty twist interval. Then we will show that $\psi(z) = z$ for all $z \in D$, by showing that the vertical foliation (definition 2.7) is a finite energy foliation.

Pick a suitable Reeb-like mapping torus (Z_1, λ_1) generating ψ . This gives us for each $n \in \mathbb{N}$ a mapping torus (Z_n, λ_n) generating the iterate ψ^n . With respect to these choices we associate real valued rotation numbers to ψ and its iterates at each fixed point and to the boundary of D . We proceed in three steps.

Step 1: The (real valued) rotation number of ψ on the boundary is an integer.

Suppose not. Then we may assume that ψ has only non-degenerate fixed points (because a degenerate fixed point has integer infinitesimal rotation number), and then the condition of no twisting would imply that the rotation number on the boundary is also an integer and we would be done.

Using that ψ has at least two fixed points one can show, using the foliations for example, or even just the Lefschetz fixed point formula, that there must be a hyperbolic fixed point with orientable stable and unstable manifolds. Since such a hyperbolic fixed point has integer infinitesimal rotation number the lack of twisting implies that the rotation number on the boundary is an integer.

^{*}Added in proof: it now appears that no assumptions on the boundary are required.

Let us say that a fixed point is *odd* if the eigenvalues of the linearization lie either on the unit circle or the negative real line. Equivalently, the corresponding periodic Reeb orbit is either degenerate or is non-degenerate and has odd parity Conley-Zehnder index.

Step 2: In this step we show that all odd fixed points have the same λ_1 -action, where we define the λ_1 -action of a fixed point $x \in D$ to be the value

$$\mathcal{A}(x) = \int_{S^1} \gamma^* \lambda_1$$

where $\gamma : S^1 \rightarrow Z_1$ is the periodic orbit corresponding to x .

Let $k \in \mathbb{Z}$ be the total rotation number of ψ on the boundary. Being an integer ψ has at least one fixed point on the boundary of D . Let $a_0 > 0$ denote the λ_1 -action of any of these boundary fixed points. It suffices to show that every interior odd fixed point of ψ has λ_1 -action equal to a_0 .

Fix any interior odd fixed point x . Let $\varepsilon > 0$. We will show that

$$|\mathcal{A}(x) - a_0| < \varepsilon.$$

Let $\gamma_x : S^1 \rightarrow Z_1$ be the corresponding closed Reeb orbit. Pick $n \in \mathbb{N}$ large enough that $\text{Area}_{d\lambda_1}(D)/n < \varepsilon$. Take a sequence of non-degenerate perturbations λ_1^j of λ_1 for which γ_x is a closed Reeb orbit for each λ_1^j also, with action converging to $\mathcal{A}(x)$. Since x is an odd fixed point of ψ , we may do this in such a way that γ_x has odd Conley-Zehnder index with respect to λ_1^j . Assume that we also perturbed near the boundary of Z_1 so that the first return map ψ_j is a rotation on the boundary of D with rotation number $k + \delta_j$, where for each j , $\delta_j \in (0, 1)$ is irrational.

By assumption ψ^n has no twist fixed points. Thus every twist interval has length zero, and $\text{Rot}_{\psi^n}(p) = \text{Rot}_{\psi^n}(\partial D) = nk$ for all $p \in \text{Fix}(\psi^n)$. Thus for sufficiently small perturbations, that is for j sufficiently large, we may assume that for each fixed point p of ψ_j^n , its twist interval is in a neighborhood of kn . For example we may assume that

$$\text{twist}_{\psi_j^n}(p) \subset \left(kn - \frac{1}{2}, kn + \frac{1}{2} \right).$$

Recall, by part (2) of Lemma 3.15, that any finite energy foliation with boundary condition outside of the twist interval of each of its spanning orbits is simple. Using ‘‘Theorem’’ 3.13 there exists a finite energy foliation $\tilde{\mathcal{F}}_j$ associated to λ_j on Z_n , having γ_x^n as a spanning orbit and any boundary condition we choose. Let us take the boundary condition to be $kn + 1$. As this is outside of every twist interval $\tilde{\mathcal{F}}_j$ must be simple.

It follows that there exists a half cylinder leaf in $\tilde{\mathcal{F}}_j$ which connects γ_x^n to the boundary. Positivity of the $d\lambda_j$ -energy of this leaf and Stokes theorem give us the following estimate:

$$\int_{S^1} (\gamma_j^n)^* \lambda_j < \int_{L_n} \lambda_j + (nk + 1) \int_{\partial D} \lambda_j$$

where L_n is any representative of the canonical longitude on ∂Z_n . Dividing by n and letting $j \rightarrow \infty$ leads to

$$\mathcal{A}(x) \leq a_0 + \frac{1}{n} \text{Area}_{d\lambda_1}(D) < a_0 + \varepsilon.$$

To complete the argument we need the lower bound $\mathcal{A}(x) > a_0 - \varepsilon$ which can be obtained in the same way by changing the boundary conditions to $nk - 1$.

Step 3: In this step we show that the vertical foliation $\tilde{\mathcal{F}}^\nu(Z_1, \lambda_1)$ is also a finite energy foliation!

See definition 2.7 to recall how we define a vertical foliation. Take any sequence of approximating data $\lambda_1^j \rightarrow \lambda_1$ with the only requirement that each be non-degenerate (for fixed points at least) and have irrational rotation number on the boundary.

Let $\tilde{\mathcal{F}}_j$ be a finite energy foliation associated to (Z_1, λ_1^j) having boundary condition k . Recall that $k \in \mathbb{Z}$ is the rotation number of ψ on the boundary. There is no need to select a spanning orbit. Then we claim that the $d\lambda$ -energies of all leaves converge to zero, that is $E_j \rightarrow 0$ where

$$E_j := \sup \left\{ \int_F d\lambda_1^j \mid F \in \tilde{\mathcal{F}}_j \right\}.$$

Roughly this is via the following argument: The value E_j must be achieved by a leaf in $\tilde{\mathcal{F}}_j$ having Fredholm index 2, since all other leaves have index 0 or 1 and lie on the boundary of a family of index-2 leaves, and the $d\lambda_1^j$ -integral is lower semi-continuous under C_{loc}^∞ -convergence. Any leaf having Fredholm index 2 has only odd index asymptotic orbits (or orbit). Any sequence of such leaves has $d\lambda_1^j$ -energy decaying to zero because in the limit the asymptotic orbits converge to odd periodic orbits of λ_1 , which by step (2) all have the same action.

It follows that the sequence $\tilde{\mathcal{F}}_j$, which has uniformly bounded E -energy, converges to the vertical foliation $\tilde{\mathcal{F}}^\nu(Z_1, \lambda_1)$ (one can also show that the limiting leaves are not constants). Thus the vertical foliation is a finite energy foliation, which means that every leaf is a cylinder over a periodic orbit. Thus the mapping torus (Z_1, λ_1) is foliated by periodic orbits. Moreover, each cylinder must be over a periodic orbit homologous to the longitude in Z_1 , thus each periodic orbit represents a fixed point of ψ . ■

4. Asymptotic Foliations for Disk Maps

In this final section we begin exploring the following broad question. What is the asymptotic behavior of the foliations associated to arbitrarily high iterates of a disk map? Do the leaves converge in a useful sense, and if so, in what way does the limit reflect anything interesting dynamically? In contrast, the applications in Section 3 only used the framework for arbitrarily high, but finite numbers of iterates.

To develop the observations we present in this section presumably requires a serious study of what one could describe as “locally-finite” energy foliations. The context is as follows.

Let (Z_1, λ_1) be a Reeb-like mapping torus, and J_1 a compatible almost complex structure on $\mathbb{R} \times Z_1$. Let $Z_\infty = \mathbb{R} \times D$ denote the universal covering space of Z_1 . The contact form and almost complex structure lift to λ_∞ and J_∞ respectively, which are invariant under the 1-shift automorphism

$$(3) \quad \begin{aligned} \tau : Z_\infty &\rightarrow Z_\infty \\ (\bar{z}, \bar{x}, \bar{y}) &\mapsto (\bar{z} + 1, \bar{x}, \bar{y}). \end{aligned}$$

One would like to take a sequence of finite energy foliations $\tilde{\mathcal{F}}_n$ associated to data (Z_n, λ_n, J_n) , as n runs over the natural numbers or some subsequence thereof, and extract a limiting object $\tilde{\mathcal{F}}_\infty$ associated to $(Z_\infty, \lambda_\infty, J_\infty)$. One would like to arrange this so that $\tilde{\mathcal{F}}_\infty$ is a foliation by leaves that are the images of properly embedded pseudoholomorphic curves, where each leaf $F \in \tilde{\mathcal{F}}_\infty$ has a parameterization that is the C_{loc}^∞ -limit of a sequence of parameterizations of leaves $F_n \in \tilde{\mathcal{F}}_n$. The foliation $\tilde{\mathcal{F}}_\infty$ would be invariant under the \mathbb{R} -action $c \cdot (a, m) \mapsto (a + c, m)$ on $\mathbb{R} \times Z_\infty$, but need not be invariant under the \mathbb{Z} -action generated by the transformation $\text{id} \times \tau$, or even a finite iterate $\text{id} \times \tau^q$.

When the contact manifold is compact it was discovered in [41] that finiteness of the E -energy picks out those holomorphic curves which do not behave too wildly, see Section 2.2. In the non-compact case $(Z_\infty, \lambda_\infty, J_\infty)$ there cannot be any non-constant curves with finite E -energy, since any such curve would pick out a periodic orbit and there are no periodic orbits in $(Z_\infty, \lambda_\infty)$. So presumably another, weaker, condition than global finiteness of the E -energy is required, perhaps some kind of averaging version of the E -energy.

Ignoring these crucial technicalities for the moment, we now outline two situations where nevertheless it is possible to see what happens asymptotically. In the first situation we will describe what happens when the disk map is integrable, the second is when the disk map has only a single periodic orbit, so called irrational pseudo-rotations which seem to have generated renewed interest in recent years [25, 24, 26, 55, 6, 7].

4.1. Detecting Invariant Circles. KAM theory guarantees the existence of closed invariant curves near a generic elliptic fixed point, or near to a given invariant circle with certain rotation number and torsion (infinitesimal twisting) conditions. In other words this is a, very successful, perturbation theory. Computer simulations indicate that generically, or often, invariant circles and quasi-periodic behavior should exist in a “global” sense, whatever this means precisely. An interesting source of pictures, numerical observations, and many questions, is MacKay’s book [64]. More evidence

for these global features arises in Aubry-Mather theory, which finds quasi-periodic behavior and invariant circles for monotone twist maps of the annulus. What about without the monotone twist assumption? Note that if one doesn't view the annulus as a cotangent bundle then the monotone twist condition is not symplectic. An argument against asking this question is of course that the so called family of standard maps $f_\tau : \mathbb{R}/\mathbb{Z} \times \mathbb{R} \rightarrow \mathbb{R}/\mathbb{Z} \times \mathbb{R}$, for parameters $\tau \in \mathbb{R}_{>0}$,

$$f_\tau(x, y) = (x + y + \tau \sin(2\pi x), y + \tau \sin(2\pi x)),$$

are all monotone twists, and still there are huge open questions regarding these very explicit examples.

In this section we do not claim any new results, or recover any known ones. We merely describe an intriguing mechanism by which finite energy foliations asymptotically pick out all the invariant circles of an integrable disk map. The circles come filtered through their rotation numbers and the elliptic periodic orbits they enclose. By integrable, we mean the time-1 map of an autonomous Hamiltonian $H : D \rightarrow \mathbb{R}$. Of course, since we are in 2-dimensions, the long term behavior of integrable Hamiltonian systems is easily understood without anything so technical as holomorphic curves. But this mechanism uses the integrability in a very weak sense that needs to be better understood, and holomorphic curves have little regard for local versus global issues. One might hope therefore that more sophisticated variations of this approach work as well in very general situations.

Let $H : D \rightarrow \mathbb{R}$ be a smooth function, constant on the boundary of D . Viewing the area form $\omega_0 := dx \wedge dy$ as a symplectic form, we have an induced, autonomous, Hamiltonian vector field X_H uniquely solving

$$-dH(x, y) = \omega_0(X_H(x, y), \cdot)$$

for all $(x, y) \in D$, and automatically X_H will vanish on the boundary of D . Let $\varphi_H^t \in \text{Diff}_{\omega_0}^t(D)$ denote the induced 1-parameter family of diffeomorphisms defined for each $t \in \mathbb{R}$, and let

$$\psi_H : D \rightarrow D$$

denote the time-1 map φ_H^1 . Then ψ_H is an area preserving and orientation preserving diffeomorphism, and its long term behavior is easily understood because its orbits remain in level curves of H .

Let us imagine that we have picked an H for which the level curves are as in Figure 18, and suppose that λ_1^H is a contact form on $Z_1 = \mathbb{R}/\mathbb{Z} \times D$ giving us a Reeb-like mapping torus for ψ_H .

Let us give names to some of the features in the figure. There are seven isolated fixed points of ψ_H , six of which lie on an "island chain" and are alternately elliptic and hyperbolic $\{h_1, e_1, h_2, e_2, h_3, e_3\}$, which in some sense enclose another elliptic fixed point e_4 .

*Added in proof: Le Calvez finds an interesting generalization of Aubry-Mather type phenomena, without any twist-like assumptions, in [56].

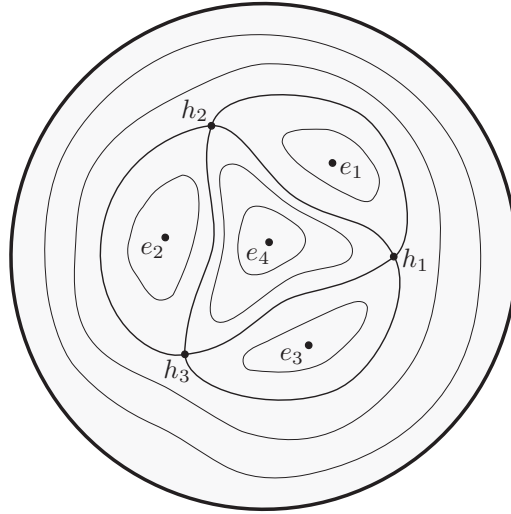

FIGURE 18. A configuration containing six fixed points which encloses an elliptic fixed point.

No matter what the flow on Z_1 is, provided it generates ψ_H as its first return map, the six fixed points on the island chain are “locked together” in the sense that any pair of them must have the same linking number. Let us assume that the flow is arranged so that this linking number is zero. In other words, for any distinct pair $x, y \in \{h_1, e_1, h_2, e_2, h_3, e_3\}$ we have $\text{lk}(x, y) = 0$, if we abbreviate $\text{lk}(x, y)$ to mean the linking number of the corresponding periodic orbits in (Z_1, λ_1^H) . Since the island chain lies “outside” of e_4 , it follows that for any $x \in \{h_1, e_1, h_2, e_2, h_3, e_3\}$ we have $\text{lk}(x, e_4) = 0$ also. So, since the linking number is a symmetric function of its entries, all seven isolated fixed points have a common linking number which is zero.

Fix any one of the isolated elliptic fixed points, e.g. e_1 . Let $\gamma_{e_1} : S^1 \rightarrow Z_1$ denote the periodic orbit in the mapping torus corresponding to the fixed point e_1 . Let k be any integer. Potentially ψ_H has other non-isolated fixed points if one of the invariant circles has rotation number an integer, in which case Theorem 3.13 only applies to a small perturbation. But to see what is going on imagine that we can nevertheless find a transversal foliation $\tilde{\mathcal{F}}^k(\gamma_{e_1})$ of Z_1 , which contains γ_{e_1} as a spanning orbit, and for which the boundary condition is the integer k . Then, by Lemma 3.12, every spanning orbit $\gamma \in \mathcal{P}(\tilde{\mathcal{F}}^k(\gamma_{e_1}))$ distinct from γ_{e_1} , (if such exists) must satisfy

$$(4) \quad \text{lk}(\gamma, \gamma_{e_1}) = k.$$

Let us denote by

$$\mathcal{P}(Z_1, \lambda^H)$$

the collection of periodic Reeb orbits in Z_1 that correspond to fixed points of ψ_H , in other words those which are homologous to the longitude L_1 . It turns out that, provided $k \neq 0$, we can characterize the subset of spanning orbits

$\mathcal{P}(\tilde{\mathcal{F}}^k(\gamma_{e_1})) \subset \mathcal{P}(Z_1, \lambda^H)$ as precisely those orbits $\gamma \in \mathcal{P}(Z_1, \lambda^H)$ which are either γ_{e_1} or which satisfy equation (4)! This is not true in general, and uses extremely weak properties of the integrability of ψ_H , and is not true for $k = 0$ without more information about ψ_H . (A more general statement along these lines, without any integrability assumptions, can be made, and may be the subject of a future paper.)

We may carry out this procedure for all iterates. The asymptotic behavior is interesting: First, fix an irrational number $\omega \in \mathbb{R}$. Now, pick any sequence of integers $k_n \in \mathbb{Z}$ such that

$$(5) \quad \lim_{n \rightarrow \infty} \frac{k_n}{n} = \omega.$$

Let $(Z_1, \lambda_1^H), (Z_2, \lambda_2^H), \dots$ be the sequence of Reeb-like mapping tori obtained by lifting (Z_1, λ_1^H) , where (Z_n, λ_n^H) generates the n -th iterate ψ_H^n . For each $n \in \mathbb{N}$, let

$$\gamma_{e_1}^n : S^1 \rightarrow Z_n$$

denote the lift of γ_{e_1} . By Theorem 3.13 we find an almost complex structure J_1 compatible with (Z_1, λ_1^H) , such that for each $n \in \mathbb{N}$ there exists a finite energy foliation $\tilde{\mathcal{F}}_n$ associated to (Z_n, λ_n^H, J_n) , where J_n denotes the lift of J_1 , with the following properties.

- $\gamma_{e_1}^n$ is a spanning orbit for $\tilde{\mathcal{F}}_n$.
- The boundary condition for $\tilde{\mathcal{F}}_n$ is the integer k_n .

Then the sequence of finite energy foliations $\tilde{\mathcal{F}}_n$ converges in a C_{loc}^∞ -sense to a locally-finite energy foliation, we will denote by $\tilde{\mathcal{F}}_\infty$, of the symplectization of the universal covering $(Z_\infty, \lambda_\infty^H, J_\infty)$, as described at the beginning of Section 4.

What do the leaves of $\tilde{\mathcal{F}}_\infty$ look like?

Let $C_1, C_2, \dots, C_m \subset D$ be those invariant circles C of the disk map ψ_H which are characterized by the following properties:

- When restricted to C , ψ_H has rotation number ω .
- C separates e_1 from the boundary of the disk. That is, e_1 and ∂D lie in different components of $D \setminus C$.

We can order these circles so that for each $j \in \{1, \dots, m-1\}$ the circle C_{j+1} is closer to the boundary than C_j . Figure 19 illustrates a possible scenario. Then it turns out that $\tilde{\mathcal{F}}_\infty$ looks something like in Figure 20.

More precisely, the leaves in $\tilde{\mathcal{F}}_\infty$ which have vanishing $d\lambda_\infty$ -energy correspond precisely to these circles and the fixed point e_1 itself. In other words, if $F \in \tilde{\mathcal{F}}_\infty$, has

$$\int_F d\lambda_\infty = 0,$$

then $F = \mathbb{R} \times \phi_z(\mathbb{R})$ is the plane over an orbit $\phi_z : \mathbb{R} \rightarrow Z_\infty$ which corresponds to the ψ -orbit of a point z in $\{e_1\} \cup C_1 \cup \dots \cup C_m$. Conversely, for every point

$$z \in \{e_1\} \cup C_1 \cup \dots \cup C_m$$

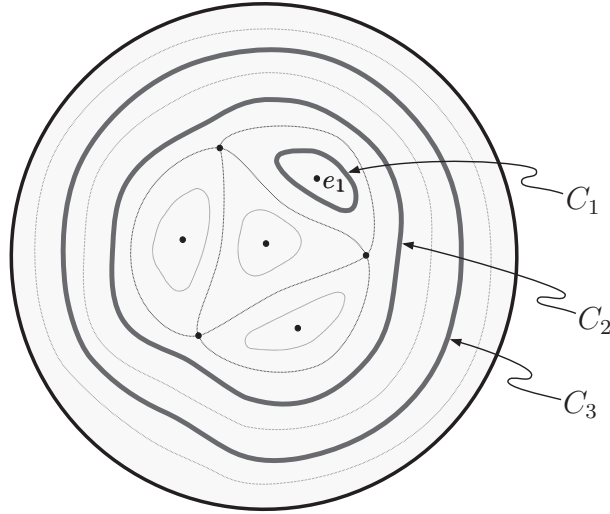

FIGURE 19.

the plane with image $\mathbb{R} \times \phi_z(\mathbb{R})$, where ϕ_z is the Reeb orbit passing through the point $(0, z) \in Z_\infty$, is a leaf in $\tilde{\mathcal{F}}_\infty$.

The remaining leaves can be described schematically as follows. Let R_1, R_2, \dots, R_m denote the open annular regions in the disk for which R_j has boundary circles C_{j-1}, C_j , for $j = 1, \dots, m$, and R_{m+1} is the remaining region between C_m and ∂D . (So R_{m+1} includes the points in the boundary of D unless $\partial D = C_m$.) For example see Figure 20. Then each leaf in $\tilde{\mathcal{F}}_\infty$ having non-zero $d\lambda_\infty$ -energy is a plane which projects down to an infinitely long open strip in the three-manifold Z_∞ . With respect to the coordinates $(\bar{z}, \bar{x}, \bar{y})$ on $Z_\infty = \mathbb{R} \times D$, the strip extends to plus and minus infinity in the \bar{z} -direction. The two boundary components of the closure of the strip are embedded copies of \mathbb{R} . Indeed, each is the image of a Reeb orbit; one corresponding to a point in some C_j or e_1 , and the other corresponding to a point in C_{j+1} or C_1 . Hence, each leaf with non-zero $d\lambda_\infty$ -energy is in some sense asymptotic to a quasi-periodic orbit of ψ_H , with rotation number ω about the chosen fixed point e_1 .

To summarize. A number of interesting issues arise when attempting to generalize this approach to finding invariant circles or quasi-periodic behavior. There are compactness issues when taking a limit of a sequence of finite energy foliations because the E -energy must blow up. Before one even takes a limit, there are questions regarding the symmetry of finite energy foliations that also seem important. For example, on the one hand it is much easier to understand symmetry of a foliation with respect to the \mathbb{Z} -action described in equation (3) when the map is integrable. On the another hand, the integrability is largely irrelevant.

With the success of KAM results in mind, one knows that Diophantine properties must play a role. It is conceivable that local KAM techniques

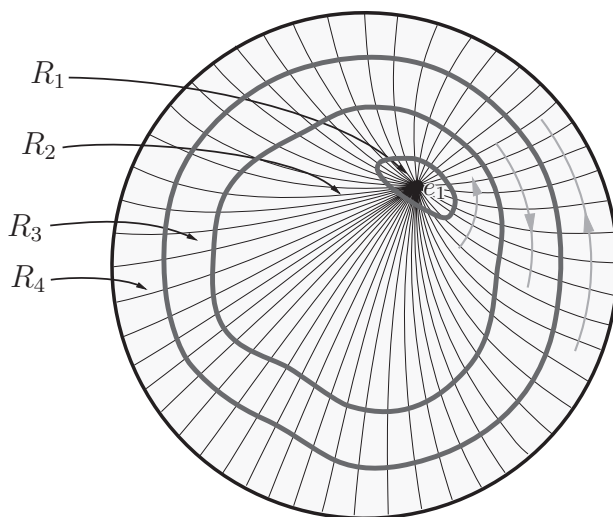

FIGURE 20. A limiting foliation for the integrable disk map ψ_H from Figure 18. The leaves with vanishing $d\lambda$ -energy correspond to the quasi-periodic orbits in the invariant circles which have the chosen rotation number ω and which surround the chosen elliptic fixed point e_1 . Each leaf with non-zero $d\lambda$ -energy is a strip connecting two such orbits on neighboring circles. The flow is transverse to these strips in alternating directions as one passes through a circle, as indicated by the grey arrows.

enter the analysis and become combined with the pseudoholomorphic curves in this framework. In the next section we describe a more concrete situation where this may be a possibility.

4.2. Speculations on Pseudo-Rotations. Pseudo-rotations (also called irrational pseudo-rotations) can be defined as smooth, orientation preserving, area preserving diffeomorphisms of the unit disk which have a single fixed point and no other periodic points. Obvious examples are rigid rotations with irrational rotation number, and smooth conjugacies of these. The question arises whether these are the only examples.

As early as 1970 Anosov and Katok constructed “exotic” examples of pseudo-rotations which are ergodic [3] and which therefore cannot be conjugated to a rotation. In all their examples the rotation number on the boundary is a Liouville number - an irrational number well approximated by rationals. Later work of Fayad and Saprykina [26] established examples for any Liouville rotation number on the boundary. Their examples are not only ergodic but weak mixing. Meanwhile, unpublished work of Herman precluded such ergodic pseudo-rotations when the rotation number on the boundary is Diophantine - those irrationals which are not Liouvillean.

This seems to have led Herman to raise the following question at his ICM address in '98: is every pseudo-rotation with Diophantine rotation number on the boundary C^∞ -smoothly conjugate to a rigid rotation? (That this is even true for circle diffeomorphisms is a deep result of his from '79 [39]).

An important step was recently taken in this direction. Fayad and Krikorian [25] proved a beautiful result, that in particular answered affirmatively a local version of Herman's question. Their approach, using KAM methods, was apparently to some degree based on ideas of Herman, and they referred to the result as "Herman's Last Geometric Theorem". They showed, that any pseudo-rotation that has Diophantine rotation number α on the boundary is C^∞ -smoothly conjugate to the rigid rotation R_α , provided the disk map is already globally sufficiently close to R_α in some C^k -topology, where k is finite and depends on α .

The global question is apparently still open. Holomorphic curves, when one has them, have proven successful at handling global problems in symplectic geometry. Placing pseudo-rotations in the framework of this paper, there are plenty of holomorphic curves available, and we speculate that there might be something new to be gained from this angle. We briefly describe where first observations lead.

Let $\psi : D \rightarrow D$ be a pseudo-rotation, which on the boundary is a genuine rotation with rotation number α . Fix a Reeb-like mapping torus (Z_1, λ_1) generating ψ as its first return map. Let $\gamma : S^1 \rightarrow Z_1$ be the unique, simply covered, periodic orbit of the Reeb flow. For each $n \in \mathbb{N}$ we have the "longer" mapping torus (Z_n, λ_n) generating ψ^n , and the unique simply covered periodic orbit we denote by γ^n . For each such n Theorem 3.11 provides finite energy foliations $\tilde{\mathcal{F}}_n^-$ and $\tilde{\mathcal{F}}_n^+$ associated to (Z_n, λ_n) which have boundary condition $\lfloor n\alpha \rfloor$ and $\lceil n\alpha \rceil$ respectively. Each has the single spanning orbit, γ^n . A schematic picture of $\tilde{\mathcal{F}}_n^-$ and $\tilde{\mathcal{F}}_n^+$, is shown in Figure 21. In general the arcs connecting the fixed point to the boundary are not perfect radial lines of course, although depicted as such in the figure.

The \mathbb{R} -action on the foliations can be translated into an \mathbb{R} -action on the projected leaves in the three-manifold Z_n , which on the disk slice D_0 induces something akin to a "radial" coordinate on the disk.

It turns out that each finite energy foliation $\tilde{\mathcal{F}}_n^-$ and $\tilde{\mathcal{F}}_n^+$ gives rise to a smooth diffeomorphism of the disk, not necessarily area preserving,

$$\varphi_n^-, \varphi_n^+ : D \rightarrow D,$$

respectively, which fix the fixed point of ψ^n , are each n -th roots of the identity map on D , and the rotation number of φ_n^- on the boundary is $\lfloor n\alpha \rfloor/n$, while the rotation number of φ_n^+ on the boundary is $\lceil n\alpha \rceil/n$. Moreover, one has the following. A similar statement for the φ_n^+ maps holds also.

THEOREM 4.1 (Bramham). *Let $\psi : D \rightarrow D$ be a pseudo-rotation with fixed point p , and coinciding with a rigid rotation on the boundary circle. Let $\alpha \in \mathbb{R}/\mathbb{Z}$ be the rotation number on the boundary. Then for each $n \in \mathbb{N}$*

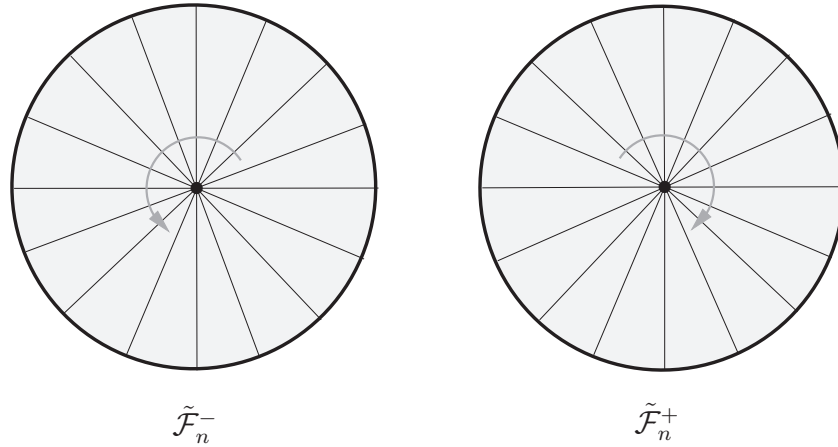

FIGURE 21. Two finite energy foliations associated to an iterate of a pseudo-rotation. On the left the trajectories pass through the leaves positively, on the right they pass through negatively.

there exists a C^∞ -diffeomorphism $\varphi_n^- : D \rightarrow D$, of finite order, which fixes the point $p \in D$, for which there exists a subsequence $\varphi_{n_j}^-$ which converges in the C^0 -topology to ψ . More precisely, $(\varphi_n^-)^n = \text{id}_D$, and the rotation number on the boundary is the projection of $[n\alpha]/n$ down to \mathbb{R}/\mathbb{Z} .

Thus each pseudo-rotation is the C^0 -limit of a sequence of maps which fill the whole disk, minus the fixed point, with smooth invariant circles. Note that no Diophantine conditions are placed on the rotation number α in this statement. Under the assumption that α is Diophantine one would like to control these circles and show that the limiting map, the pseudo-rotation being examined, also fills the disk with invariant circles.

If Herman's question is answered affirmatively, one could also ask the following question about Liouvillean pseudo-rotations. Does every pseudo-rotation with Liouvillean rotation number at least lie in the closure, perhaps in the C^∞ -topology, of the set

$$\chi = \{h \circ R_t \circ h^{-1} \mid t \in \mathbb{R}/\mathbb{Z}, h \in \text{Diff}_{\omega_0}(D)\}.$$

Here R_t denotes the rotation through angle $2\pi t$ and $\text{Diff}_{\omega_0}(D)$ refers to the smooth, area preserving, orientation preserving, diffeomorphisms. This is apparently unknown. If this were the case, it would mean that all pseudo-rotations which are conjugate to rotations lie in χ , while all those which are not lie on the boundary of χ . Theorem 4.1 suggests that the finite energy foliations might provide a way to approach this question. Both authors hope to explore these ideas in the future.

4.3. Questions about the Asymptotic Behavior of Finite Energy Foliations and Disk Maps.

QUESTION 4.2. Suppose that the area preserving disk map ψ has an elliptic fixed point $e \in D$ with irrational infinitesimal rotation number ω . See definition 3.6. Suppose moreover that ψ has a unique invariant circle, or quasi-periodic orbit, C surrounding e . If ψ is the time-1 map of an autonomous Hamiltonian then we described above a method by which a suitably chosen sequence of finite energy foliations picks out C . Does the same approach pick out C without the global integrability assumption on ψ ?

QUESTION 4.3. Can one, and if so how, recover results of Aubry-Mather theory using the foliations? That is, assume that the disk map ψ is a monotone twist map on the complement of the fixed point $0 \in D$. How do we find quasi-periodic orbits surrounding 0 for all rotation numbers in the twist interval of 0 ? Can one do this using assumptions of monotone twist maps which are symplectic, that is, which remain true under any symplectic change of coordinates? For example, using only say some inequalities on the Conley-Zehnder indices of period orbits?

Suppose that $\tilde{\mathcal{F}}_j$, over $j \in \mathbb{N}$, is a sequence of finite energy foliations associated to (Z_{n_j}, λ_{n_j}) , where (Z_1, λ_1) is a Reeb-like mapping torus generating $\psi : D \rightarrow D$, and n_j is a sequence of integers tending to $+\infty$. Let $k_j \in \mathbb{Z}$ be the boundary condition for $\tilde{\mathcal{F}}_j$.

QUESTION 4.4. Suppose that $e \in \text{Fix}(\psi)$ is an interior fixed point, let us say elliptic. Let $\gamma_e : S^1 \rightarrow Z_1$ be the corresponding periodic Reeb orbit. Suppose that for each j there exists a closed cycle C_j of rigid leaves in $\tilde{\mathcal{F}}_j$, whose projection down to Z_{n_j} separates $\gamma_e^{n_j}$ from the boundary of Z_{n_j} , and satisfies:

- (1) The sequence $E_j := \max\{E_{d\lambda_{n_j}}(F) \mid F \in C_j\}$ converges to zero.
- (2) The ratio k_j/n_j converges to some irrational number $\omega \in \mathbb{Q}^c$.
- (3) Each C_j is invariant under the automorphism $\tau : \mathbb{R} \times Z_{n_j} \rightarrow \mathbb{R} \times Z_{n_j}$ where $\tau(a, z, x, y) = (a, z + 1, x, y)$, meaning that for each leaf $F \in C_j$, we have $\tau(F) \in C_j$.

Let $S_j \subset D \setminus \{e\}$ be the unparameterized circle given by:

$$S_j := \{z \in D \mid \text{there exists } F \in C_j \text{ such that } (0, z) \in \text{pr}(F)\}$$

where $\text{pr} : \mathbb{R} \times Z_{n_j} \rightarrow Z_{n_j}$ is the projection.

The question then is: are there further conditions under which the sequence S_j of compact connected subsets of $D \setminus \{e\}$ converges in some sense to a closed ψ -invariant subset of $D \setminus \{e\}$ on which all points have rotation number ω about e ?

Recall the deck transformation $\tau : Z_\infty \rightarrow Z_\infty$ given by $\tau(\bar{z}, \bar{x}, \bar{y}) = (\bar{z} + 1, \bar{x}, \bar{y})$.

DEFINITION 4.5. For an integer $q \in \mathbb{Z}$, let us say that an \mathbb{R} -invariant foliation $\tilde{\mathcal{F}}_\infty$ by pseudoholomorphic curves associated to $(Z_\infty, \lambda_\infty, J_\infty)$ is *q-shift invariant* if for every leaf $F \in \tilde{\mathcal{F}}_\infty$ we have $\text{id} \times \tau^q(F)$ is also a leaf.

An easy observation is that if $\tilde{\mathcal{F}}_\infty$ is q -shift invariant, then the subcollection of leaves having vanishing $d\lambda_\infty$ -energy picks out a ψ^q -invariant subset of the disk. Indeed, let $\Omega \subset D$ be the set of $z \in D$ such that the plane

$$F = \mathbb{R} \times \phi_z(\mathbb{R}),$$

over the Reeb orbit $\phi_z : \mathbb{R} \rightarrow Z_\infty$ characterized by $\phi_z(0) = (0, z)$, is a leaf in $\tilde{\mathcal{F}}_\infty$. Then, since $\tau^q(\mathbb{R} \times \phi_z(\mathbb{R})) = \mathbb{R} \times \phi_{\psi^{-q}(z)}(\mathbb{R})$ is always true, then if $z \in \Omega$, then $\tau^q(F) \in \tilde{\mathcal{F}}_\infty$ implies that $\mathbb{R} \times \phi_{\psi^{-q}(z)}(\mathbb{R})$ is a leaf in $\tilde{\mathcal{F}}_\infty$, and so $\psi^{-q}(z) \in \Omega$. Thus $\psi^{-q}(\Omega) \subset \Omega$. Similarly as q -shift invariance implies $(-q)$ -shift invariance, $\psi^q(\Omega) \subset \Omega$, and so $\psi^q(\Omega) = \Omega$.

QUESTION 4.6. Is a statement along the following lines true? Consider a sequence $\tilde{\mathcal{F}}_n$ of finite energy foliations associated to Reeb-like mapping tori $(Z_1, \lambda_1), (Z_2, \lambda_2), \dots$ where (Z_1, λ_1) generates the area preserving disk map ψ . Suppose that the sequence of foliations $\tilde{\mathcal{F}}_n$ converges in a C_{loc}^∞ -sense to a foliation $\tilde{\mathcal{F}}_\infty$ associated to the universal covering $(Z_\infty, \lambda_\infty)$. Suppose that $\tilde{\mathcal{F}}_\infty$ is q -shift invariant, for some $q \in \mathbb{Z}$. Let $\Omega \subset D$ be the set of points $z \in D$ such that the plane

$$F = \mathbb{R} \times \phi_z(\mathbb{R}),$$

over the Reeb orbit $\phi_z : \mathbb{R} \rightarrow Z_\infty$ characterized by $\phi_z(0) = (0, z)$, is a leaf in $\tilde{\mathcal{F}}_\infty$. We just saw that ψ^q restricts to a map on Ω . Then the question is, are there interesting general assumptions under which ψ^q must have zero topological entropy on Ω ?

Note that in the last question one needs to rule out the vertical foliation $\tilde{\mathcal{F}}^\nu(Z_\infty, \lambda_\infty)$, as Ω for this is the whole disk regardless of the dynamics. Of course the vertical foliation is q -shift invariant for all $q \in \mathbb{Z}$, so this condition does not rule it out. This is another reason to phrase it so that $\tilde{\mathcal{F}}_\infty$ is achieved as a limit of finite energy foliations; then one could perhaps place assumptions on the sequence such as uniform bounds on some average notion of energy, or average of the boundary conditions, to rule out obtaining this trivial foliation.

Acknowledgment

This material is based upon work supported by the National Science Foundation under agreement No. DMS-0635607 (BB) and by NSF DMS-1047602 (HH). Any opinions, findings and conclusions or recommendations expressed in this material are those of the authors and do not necessarily reflect the views of the National Science Foundation.

References

- [1] P. Albers, U. Frauenfelder, O. van Koert, G. Paternain, The contact geometry of the restricted 3-body problem, arXiv:1010.2140
- [2] P. Albers and H. Hofer, On the Weinstein conjecture in higher dimensions. *Comment. Math. Helv.* 84 (2009), no. 2, 429–436.
- [3] D.V. Anosov, A.B. Katok, New examples in smooth ergodic theory. *Ergodic diffeomorphisms*. *Trans. Moscow Math. Soc.* 23 (1970), 1–35.
- [4] V. Bangert, On the existence of closed geodesics on two-spheres. *Internat. J. Math.* 4 (1993), no. 1, 1–10.
- [5] J. Barrow-Green, Poincaré and the three body problem. *History of Mathematics*, 11. American Mathematical Society, Providence, RI; London Mathematical Society, London, 1997.
- [6] F. Béguin, S. Crovisier, F. Le Roux, A Patou, Pseudo-rotations of the closed annulus: variation on a theorem of J. Kwapisz. *Nonlinearity* 17 (2004), 1427–1453.
- [7] Béguin, F., Crovisier, S., Le Roux, F., Pseudo-rotations of the open annulus. *Bull. Braz. Math. Soc. (N.S.)* 37 (2006), no. 2, 275–306.
- [8] G.D. Birkhoff, Proof of Poincaré’s geometric theorem. *Trans. Amer. Math. Soc.* 14 (1913), no. 1, 14–22.
- [9] G.D. Birkhoff, An extension of Poincaré’s last geometric theorem. *Acta Math.* 47 (1926), no. 4, 297–311.
- [10] F. Bourgeois, Y. Eliashberg, H. Hofer, K. Wysocki and E. Zehnder, Compactness Results in Symplectic Field Theory, *Geometry and Topology*, Vol. 7 (2003), pp. 799–888.
- [11] B. Bramham, Pseudoholomorphic Foliations for Area Preserving Disc Maps, Ph.D.-thesis, New York University 2008.
- [12] B. Bramham, A dynamical application of finite energy foliations to area preserving disc maps, in preparation.
- [13] B. Bramham, Finite energy foliations with chosen binding orbits, in preparation.
- [14] B. Bramham, Finite energy foliations with chosen binding orbits II, in preparation.
- [15] M. Brown and W. Neumann, Proof of the Poincaré-Birkhoff fixed point theorem. *Michigan Math. J.* 24 (1977), no. 1, 21–31.
- [16] P.H. Carter, An improvement of the Poincaré-Birkhoff fixed point theorem. *Trans. Amer. Math. Soc.* 269 (1982), no. 1, 285–299.
- [17] K. Cieliebak, U. Frauenfelder and O. van Koert, The Cartan geometry of the rotating Kepler problem, preprint.
- [18] Collier, Kerman, Reiniger, Turmunkh, Zimmer, A symplectic proof of a theorem of Franks. arXiv:1107.1282.
- [19] C. Conley and E. Zehnder, The Birkhoff-Lewis fixed point theorem and a conjecture of V. I. Arnol’d. *Invent. Math.* 73 (1983), no. 1, 33–49.
- [20] A. Cotton-Clay, A sharp bound on fixed points of surface symplectomorphisms in each mapping class, arXiv:1009.0760.
- [21] W.-Y. Ding, A generalization of the Poincaré-Birkhoff theorem. *Proc. Amer. Math. Soc.* 88 (1983), no. 2, 341–346.
- [22] Y. Eliashberg, A. Givental, H. Hofer, Introduction to Symplectic Field Theory, *Geom. Funct. Anal.* (2000), Special Volume, Part II, 560–673.
- [23] Y. Eliashberg and H. Hofer, A Hamiltonian characterization of the three-ball. *Differential Integral Equations* 7 (1994), no. 5–6, 1303–1324.
- [24] B. Fayad, A. Katok, Constructions in elliptic dynamics. *Ergodic Theory Dynam. Systems* 24 (2004), no. 5, 1477–1520.
- [25] B. Fayad, R. Krikorian, Herman’s last geometric theorem, *Ann. Sci. Ecole Norm. Sup.* 42 (2009), 193–219.

- [26] B. Fayad, M. Saprykina, Weak mixing disc and annulus diffeomorphisms with arbitrary Liouville rotation number on the boundary. *Ann. Sci. École Norm. Sup. (4)* 38 (2005), 339–364.
- [27] A. Floer, H. Hofer, C. Viterbo, The Weinstein conjecture in $P \times C^l$. *Math. Z.* 203 (1990), no. 3, 469–482.
- [28] J. Franks, Generalizations of the Poincaré-Birkhoff theorem. *Ann. of Math. (2)* 128 (1988), no. 1, 139–151.
- [29] J. Franks, A variation on the Poincaré-Birkhoff Theorem, *Contemp. Math.*, 81, Amer. Math. Soc., Providence, RI, 1988, 111–117.
- [30] J. Franks, Geodesics on S^2 and periodic points of annulus homeomorphisms. *Invent. Math.* 108 (1992), no. 2, 403–418.
- [31] J. Franks, Rotation vectors and fixed points of area preserving surface diffeomorphisms. *Trans. Amer. Math. Soc.* 348 (1996), no. 7, 2637–2662.
- [32] J. Franks and M. Handel, Periodic points of Hamiltonian surface diffeomorphisms, *Geom. Topol.* 7 (2003), 713–756.
- [33] J. Franks, Rotation and numbers and instability sets. *Bull. Amer. Math. Soc. (N.S.)* 40 (2003), no. 3, 263–279.
- [34] J. Franks and P. Le Calvez, Regions of instability for non-twist maps. *Ergodic Theory Dynam. Systems* 23 (2003), no. 1, 111–141.
- [35] H. Geiges, *An Introduction to Contact Topology*, Cambridge studies in advanced mathematics, vol. 109.
- [36] M. Gromov, Pseudoholomorphic Curves in Symplectic Geometry, *Invent. Math.* Vol. 82 (1985), 307–347.
- [37] L. Guillou, Théorème de translation plane de Brouwer et généralisations du théorème de Poincaré-Birkhoff, *Topology*, 33 (1994), 331–351.
- [38] L. Guillou, A simple proof of P. Carter’s theorem, *Proc. Amer. Math. Soc.*, 125 (1997), 1555–1559.
- [39] M. Herman, Sur la conjugaison différentiable des difféomorphismes du cercle à des rotations. (French) *Inst. Hautes Études Sci. Publ. Math.* No. 49 (1979), 5–233.
- [40] N. Hingston, On the growth of the number of closed geodesics on the two-sphere, *Internat. Math. Res. Notices* (1993), no. 9, 253–262.
- [41] H. Hofer, Pseudoholomorphic curves in symplectizations with applications to the Weinstein conjecture in dimension three. *Invent. Math.* 114 (1993), no. 3, 515–563.
- [42] H. Hofer, C. Viterbo, The Weinstein conjecture in the presence of holomorphic spheres. *Comm. Pure Appl. Math.* 45 (1992), no. 5, 583–622.
- [43] H. Hofer, K. Wysocki and E. Zehnder, Properties of pseudo-holomorphic curves in symplectisations. II. Embedding controls and algebraic invariants. *Geom. Funct. Anal.* 5 (1995), no. 2, 270–328.
- [44] H. Hofer, K. Wysocki and E. Zehnder, The dynamics on three-dimensional strictly convex energy surfaces. *Ann. of Math. (2)* 148 (1998), no. 1, 197–289.
- [45] H. Hofer, K. Wysocki and E. Zehnder, Pseudoholomorphic curves and dynamics in three dimensions. *Handbook of dynamical systems*, Vol. 1A, 1129–1188, North-Holland, Amsterdam, 2002.
- [46] H. Hofer, K. Wysocki and E. Zehnder, Finite energy foliations of tight three-spheres and Hamiltonian dynamics. *Ann. of Math. (2)* 157 (2003), no. 1, 125–255.
- [47] U. Hryniewicz, *Finite Energy Foliations for Convex Sets in \mathbb{R}^4* , Ph.D.-thesis, New York University 2008.
- [48] U. Hryniewicz, *Fast finite-energy planes in symplectizations and applications*, to appear *Transactions of the AMS*.
- [49] U. Hryniewicz and P. Salomao, On the existence of disk-like global sections for Reeb flows on the tight 3-sphere, arXiv:1006.0049.
- [50] A. Katok, Five most resistant problems in dynamics, MSRI-Evans Lecture, Berkeley September 2004.

- [51] B. Kerékjártó, Über die periodischen Transformationen der Kreisscheibe und der Kugelfläche, *Math. Ann.* 80 (1919–1920), 36–38.
- [52] B. Kerékjártó, The plane translation theorem of Brouwer and the last geometric theorem of Poincaré, *Acta Sci. Math. Szeged*, (4) (1928–1929), 86–102.
- [53] G. Kuperberg, A volume-preserving counterexample to the Seifert conjecture, *Comment. Math. Helv.* 71, no. 1:70–97, 1996.
- [54] K. Kuperberg, A smooth counter example to the Seifert conjecture in dimension three, *Annals of Mathematics*, 140:723–732, 1994.
- [55] J. Kwapisz, Combinatorics of torus diffeomorphisms. *Ergodic Theory Dynam. Systems* 23 (2003), 559–586.
- [56] P. Le Calvez, Ensembles invariants non enlacs des difféomorphismes du tore et de l’anneau. (Unlinked invariant sets of torus and annulus diffeomorphisms). *Invent. Math.* 155 (2004), no. 3, 561–603.
- [57] P. Le Calvez, Une version feuilletée du théorème de Brouwer. *Comment. Math. Helv.* 79 (2004), 229–259.
- [58] P. Le Calvez, Une version feuilletée équivariante du théorème de translation de Brouwer. *Inst. Hautes Études Sci. Publ. Math.* 102 (2006), 1–98.
- [59] P. Le Calvez, Periodic orbits of Hamiltonian homeomorphisms of surfaces. *Duke Math. J.* 133 (2006), no. 1, 125–184.
- [60] P. Le Calvez, From Brouwer theory to the study of homeomorphisms of surfaces. *International Congress of Mathematicians. Vol. III*, 77–98, Eur. Math. Soc., Zürich, 2006.
- [61] P. Le Calvez, Pourquoi les points périodiques des homeomorphismes du plan tournent-ils autour de certains points fixes?, *Ann. Sci. Ec. Norm. Super.* (4) 41 (2008), no. 1, 141–176.
- [62] P. Le Calvez and J. Wang, Some remarks on the Poincaré-Birkhoff theorem. *Proc. Amer. Math. Soc.* 138 (2010), no. 2, 703–715.
- [63] G. Liu, G. Tian, Weinstein conjecture and GW-invariants. *Commun. Contemp. Math.* 2 (2000), no. 4, 405–459.
- [64] R. S. MacKay, *Renormalisation in area-preserving maps. Advanced Series in Nonlinear Dynamics*, 6. World Scientific Publishing Co., Inc., River Edge, NJ, 1993.
- [65] A. Momin, Cylindrical Contact Homology on Complements of Reeb Orbits, arXiv:1003.3268
- [66] A. Momin, Contact Homology of Orbit Complements and Implied Existence, arXiv:1012.1386
- [67] W. Neumann, Generalizations of the Poincaré-Birkhoff fixed point theorem. *Bull. Austral. Math. Soc.* 17 (1977), no. 3, 375–389,
- [68] Á Pelayo, S. Vũ Ngọc, Semitoric integrable systems on symplectic 4-manifolds. *Invent. Math.* 177 (2009) 571–597.
- [69] Á Pelayo, S. Vũ Ngọc, Constructing integrable systems of semitoric type. *Acta Math.* 206 (2011) 93–125.
- [70] H. Poincaré, Sur un théorème de géométrie, *Rend. Circ. Mat. Palermo*, 33 (1912), 375–407.
- [71] H. Seifert, Closed integral curves in 3-space and isotopic two-dimensional deformations, *Proc. Amer. Math. Soc.*, 1 (1950), 287–302.
- [72] R. Siefring, Intersection theory of punctured pseudoholomorphic curves, arXiv:0907.0470.
- [73] C. Taubes, The Seiberg-Witten equations and the Weinstein conjecture. *Geom. Topol.* 11 (2007), 2117–2202.
- [74] C. Viterbo, A proof of Weinstein’s conjecture in \mathbb{R}^{2n} . *Ann. Inst. H. Poincaré Anal. Non Linéaire* 4 (1987), no. 4, 337–356.

- [75] A. Weinstein, On the hypotheses of Rabinowitz' periodic orbit theorems. *J. Differential Equations* 33 (1979), no. 3, 353–358.
- [76] A. Weinstein, Lectures on symplectic manifolds, Regional Conference Series in Mathematics, No. 29. American Mathematical Society, Providence, R.I., 1977. iv+48 pp.
- [77] C. Wendl, Finite Energy Foliations and Surgery on Transverse Links, Ph.D.-thesis, New York University 2005.
- [78] C. Wendl, Finite energy foliations on overtwisted contact manifolds. *Geom. Topol.* 12 (2008), no. 1, 531–616.
- [79] C. Wendl, Strongly fillable contact manifolds and J -holomorphic foliations. *Duke Math. J.* 151 (2010), no. 3, 337–384.

INSTITUTE FOR ADVANCED STUDY, PRINCETON, NJ 08540

E-mail address: bramham@ias.edu

E-mail address: hofer@ias.edu

