

Uniqueness of open/closed rational CFT with given algebra of open states

Jens Fjelstad^{1,2}, Jürgen Fuchs², Ingo Runkel³, and Christoph Schweigert⁴

¹Cardiff School of Mathematics, Cardiff University, Senghennydd Road,
GB, Cardiff CF24 4AG, UK

²Avdelning fysik, Karlstads Universitet, Universitetsgatan 5, S-651 88
Karlstad, Sweden

³Department of Mathematics, King's College London, Strand, GB, London
WC2R 2LS, UK

ingo.runkel@kcl.ac.uk

⁴Organisationseinheit Mathematik, Universität Hamburg, Schwerpunkt
Algebra und Zahlentheorie, Bundesstraße 55, D-20 146 Hamburg, Germany

Abstract

We study the sewing constraints for rational two-dimensional conformal field theory on oriented surfaces with possibly nonempty boundary. The boundary condition is taken to be the same on all segments of the boundary. The following uniqueness result is established: for a solution to the sewing constraints with nondegenerate closed state vacuum and nondegenerate two-point correlators of boundary fields on the disk and of bulk fields on the sphere, up to equivalence all correlators are uniquely determined by the one-, two- and three-point correlators on the disk.

Thus for any such theory every consistent collection of correlators can be obtained by the topological field theory approach of [1, 2]. As morphisms of the category of world sheets we include not only homeomorphisms, but also sewings; interpreting the correlators as a natural transformation then encodes covariance both under homeomorphisms and under sewings of world sheets.

CONTENTS

1.	Introduction	1285
2.	Summary	1288
3.	Open/closed sewing constraints	1292
3.1.	Oriented open/closed topological world sheets	1292
3.2.	Modular tensor categories and 3D TFT	1298
3.3.	Assigning the space of blocks to a world sheet	1302
3.4.	Correlators and sewing constraints	1311
3.5.	Equivalence of solutions to the sewing constraints	1312
4.	Frobenius algebras and solutions to the sewing constraints	1315
4.1.	Fundamental correlators	1315
4.2.	Projecting onto the closed state vacuum	1319
4.3.	From Frobenius algebras to a solution to the sewing constraints	1327
4.4.	From a solution to the sewing constraints to a Frobenius algebra	1337
4.5.	The uniqueness theorem	1346
5.	Proof of the uniqueness theorem	1348

<i>UNIQUENESS OF OPEN/CLOSED RATIONAL CFT</i>	1285
5.1. A morphism φ_{cl}^A from H_{cl} to $Z(A)$	1349
5.2. φ_{cl}^A is a monomorphism	1354
5.3. φ_{cl}^A is an epimorphism	1358
5.4. Equivalence of solutions	1361
6. CFT on world sheets with metric	1367
6.1. Conformal world sheets and conformal blocks	1367
6.2. Consistency conditions for correlation functions	1368
Acknowledgments	1371
References	1372

1 Introduction

To get a good conceptual and computational grasp on two-dimensional conformal field theory (2D CFT) has been a challenge for a long time. Several rather different aspects need to be comprehended, ranging from analytic and algebro-geometric questions to representation theoretic and combinatorial issues. Though considerable progress has been made on some of these, compare e.g., the books [3–5], it seems fair to say that at present the understanding of CFT is still not satisfactory. For example, heuristically one expects various models describing physical systems to furnish “good” CFTs, but a precise mathematical description is often missing.

One early, though not always sufficiently appreciated, insight has been that one must distinguish carefully between chiral and full CFT. For instance, in chiral CFT the central objects of study are the bundles of conformal blocks and their sections which are, in general, multivalued, while in full CFT one considers correlators which are actual functions of the locations of field insertions and of the moduli of the world sheet. It has also been commonly taken for granted that at least in the case of *rational* conformal field theory (RCFT), every full CFT can be understood with the help of a corresponding chiral CFT, e.g., any correlation function of the full CFT can be described as a specific element in the relevant space of conformal blocks

of a chiral CFT. In fact (as again realized early [6]) what is relevant to a full CFT on a world sheet X is a chiral CFT on a complex double of X , compare e.g., [7–10]. More recently, it has been established that for rational CFT this indeed leads to a clean separation of chiral and nonchiral aspects and, moreover, that the relation between chiral and full CFT can be studied entirely in a model-independent manner when taking the representation category \mathcal{C} of the chiral symmetry algebra as a starting point. More specifically, in a series of papers [1, 2, 11, 12] it was shown how to obtain a consistent set of defining quantities like field contents and operator product coefficients, from algebraic structures in the category \mathcal{C} .

At the basis of the results of [1, 2, 11, 12] lies the idea that for constructing a full CFT, in addition to chiral information only a single further datum is required, namely a simple symmetric special Frobenius algebra¹ A in \mathcal{C} . Given such an algebra A , a consistent set of combinatorial data determining all correlators, i.e., the types of field insertions, boundary conditions and defect lines, can be expressed in terms of the representation theory of A — boundary conditions are given by A -modules and defect lines by² A -bimodules, while bulk, boundary and defect fields are particular types of (bi)module morphisms. We work in the setting of rational CFT, so that the category \mathcal{C} is a modular tensor category. Exploiting the relationship [15, 16] between modular tensor categories and three-dimensional topological field theory (3D TFT), one can then specify each correlator of a full rational CFT, on a world sheet of arbitrary topology, as an element in the relevant space of conformal blocks, by representing it as the invariant of a suitable ribbon graph in a three-manifold. The correlators obtained this way can be proven [2] to satisfy all consistency conditions that the correlators of a CFT must obey. Thus, specifying the algebra A is sufficient to obtain a consistent system of correlators; in contrast, in other approaches to CFT only a restricted set of correlators and of constraints can be considered, so that only some necessary consistency conditions can be checked. Another feature of our approach is that Morita equivalent algebras give equivalent systems of correlators; it can be shown that in any modular tensor category there is only a finite number of Morita classes of simple symmetric special Frobenius algebras, so that only a finite number of distinct full CFTs can share a given chiral RCFT.

¹One must actually distinguish between full CFT on oriented and on unoriented (including in particular unorientable) world sheets. In the unoriented case the algebra A must in addition come with a reversion (a braided analogue of an involution), see [2, 13] for details. In the present paper we restrict our attention to the oriented case.

²More generally, for any pair A, B of simple symmetric special Frobenius algebras, the A - B -bimodules give defect lines separating regions in which the CFT is specified by A and B , respectively [12, 14].

It was also explained in [1] how one may extract a simple symmetric special Frobenius algebra from a given full CFT that is defined on world sheets with boundary: it is the algebra of boundary fields for a given boundary condition (different boundary conditions give rise to Morita equivalent algebras). On the other hand, what could not be shown so far is that a full CFT is already uniquely specified by this algebra; thus it was e.g., unclear whether the correlators constructed from the algebra of boundary fields in the manner described in [1, 2] coincide with those of the full CFT one started with. It is this issue that we address in the present paper. We formulate a few universal conditions that should be met in every RCFT³ and establish that under these conditions and for a given algebra of boundary fields the constraints on the system of correlators have a unique solution (see Theorem 4.26). Thus up to equivalence, the correlators must be the same as those obtained in the construction of [1, 2] from the algebra of boundary fields. In other words, we are able to show that, under reasonable conditions, *every* consistent collection of RCFT correlators can be obtained by the methods of [1, 2].

Even for RCFT, some major issues are obviously left unsettled by the approach of [1, 2, 11, 12]. While it efficiently identifies such quantities of a CFT which only depend on the topological and combinatorial data of the world sheet and the field insertions, in a complete picture the conformal structure of the world sheet plays an important role and one must even specify a concrete metric as a representative of its conformal equivalence class. In particular the relation between chiral and full CFT is described only at the level of topological surfaces, and the construction yields a correlator just as an element of an abstract vector space of conformal blocks and must be supplemented by a concrete description of the conformal blocks in terms of invariants in tensor products of modules over the chiral symmetry algebra. (Note, however, that often the latter aspects are not of primary importance. For instance, a lot of interesting information about a CFT is contained in the coefficients of partition functions and in the various types of operator product coefficients, and these can indeed be computed [11] with our methods.) To alert the reader about this limitation, below we will refer to the surfaces we consider as *topological world sheets*. But this qualification must not be confused with the corresponding term for field theories. Our approach applies to all RCFTs, not only to 2D TFTs, whose correlation functions are independent of the location of field insertions.

To go beyond the combinatorial framework studied here, one has to promote the geometric category of topological world sheets to a category of world sheets with metric and similarly for the relevant algebraic category of

³We also have to make a technical assumption concerning the values of quantum dimensions. This condition might be stronger than necessary.

vector spaces, for the relevant functors between them and for natural transformations. Some ideas on how this can be achieved concretely are presented at the end of this paper. Confidence that this approach can be successful comes from the result of [4] that the notions of a (\mathcal{C} -decorated) topological modular functor and of a (\mathcal{C} -decorated) complex-analytic modular functor are equivalent.

2 Summary

Let us briefly summarize the analysis of CFT pursued in Sections 3–5. We assume from the outset that we are given a definite modular tensor category \mathcal{C} , and we make extensive use of the 3D TFT that is associated to \mathcal{C} . Note that for our calculations we do not have to assume that \mathcal{C} is the category of representations of a suitable chiral algebra (concretely, a conformal vertex algebra). However, if we want to interpret the quantities that describe correlators in our framework as actual correlation functions of CFT on world sheets with metric, we do need an underlying chiral algebra \mathcal{V} such that $\mathcal{C} = \mathcal{R}ep(\mathcal{V})$ and such that in addition the 3D TFT associated to \mathcal{C} correctly encodes the sewing and monodromy properties of the conformal blocks (compare Section 6).

In Section 3.1 we describe the relevant geometric category \mathcal{WSh} whose objects are topological world sheets. Its morphisms do not only consist of homeomorphisms of topological world sheets, but we also introduce sewings as morphisms; \mathcal{WSh} is a symmetric monoidal category. In this paper we treat the boundary segments⁴ of a world sheet as unlabelled. In more generality, one can assign different conformal boundary conditions to different connected components (or, in the presence of boundary fields, segments) of the boundary. In the category theoretic setting, boundary conditions are labelled by modules over the relevant Frobenius algebra in \mathcal{C} , see [1, Section 4] and [2, Section 4]. Working with unlabelled boundaries corresponds to having selected one specific conformal boundary condition which we then assign to all boundaries.

In Section 3.2 we recall the definition of a modular tensor category and the way in which it gives rise to a 3D TFT, i.e., to a monoidal functor $tft_{\mathcal{C}}$ from a geometric category to the category \mathcal{Vect} of finite-dimensional complex vector spaces. The 3D TFT is then used, in Section 3.3, to construct a monoidal functor $B\ell$ from \mathcal{WSh} to \mathcal{Vect} . We also introduce a “trivial” functor $One: \mathcal{WSh} \rightarrow \mathcal{Vect}$, which assigns the ground field \mathbb{C} to every object

⁴In the terminology of Section 3.1, these are the “physical boundaries.”

and $\text{id}_{\mathcal{C}}$ to every morphism in \mathcal{WSh} . Given these two functors, we define in Section 3.4 a collection Cor of correlators as a monoidal natural transformation from One to Bl . The properties of a monoidal natural transformation furnish a convenient way to encode the consistency conditions, or sewing constraints, that a collection of correlators must satisfy (see Section 6 for a discussion). Accordingly, we will say that Cor provides a solution S to the sewing constraints. More precisely, besides Cor some other data need to be prescribed (see Section 3.4), in particular the open and closed state spaces, which are objects H_{op} of \mathcal{C} and H_{cl} of the product category $\mathcal{C} \boxtimes \overline{\mathcal{C}}$, respectively. Different solutions S and S' can describe CFTs that are physically equivalent; a corresponding notion of equivalence of solutions to the sewing constraints is introduced in Section 3.5.

Section 4.1 recalls how sewing can be used to construct any world sheet from a small collection of fundamental world sheets. To apply this idea to correlators one needs an operation of “projecting onto the closed state vacuum;” this is studied in Section 4.2.

The results of [1, 2] show in particular that any symmetric special Frobenius algebra A in \mathcal{C} gives rise to a solution $S = S(\mathcal{C}, A)$ to the sewing constraints. Together with some other background information this is reviewed briefly in Section 4.3. Afterwards, in Sections 4.4 and 4.5, we come to the main subject of this paper: we study how, conversely, a solution to the sewing constraints gives rise to a Frobenius algebra A in \mathcal{C} . The ensuing uniqueness result is stated in Theorem 4.26; it asserts that every solution S to the sewing constraints is of the form $S(\mathcal{C}, A)$, with an (up to isomorphism) uniquely determined algebra A , provided that the following conditions are fulfilled:

- (i) There is a unique “vacuum” state in H_{cl} , in the sense that the vector space $\text{Hom}_{\mathcal{C} \boxtimes \overline{\mathcal{C}}}(\mathbf{1} \times \overline{\mathbf{1}}, H_{\text{cl}})$ is one-dimensional.
- (ii) The correlator of a disk with two boundary insertions is nondegenerate.
- (iii) The correlator of a sphere with two bulk insertions is nondegenerate.
- (iv) The quantum dimension of H_{op} is nonzero, and for each subobject $U_i \times \overline{U}_j$ of the full centre of A (as defined in Section 4.3 below) the product $\dim(U_i) \dim(U_j)$ of quantum dimensions is positive.

The proof of this theorem is given in Section 5. It shows, in particular, that a solution to the sewing constraints is determined up to equivalence by the correlators assigned to disks with one, two and three boundary insertions. The conditions (i), (ii) and (iii) are necessary; if any of them is removed, one can find counterexamples, see Remark 4.27 (i). Condition (iv), on the other hand, appears to be merely a technical assumption used in our proof, and can possibly be relaxed, or dropped altogether.

Table 1: Symbols for basic quantities.

Symbol	Quantity	Introduced in
\mathcal{WSh}	Category of open/closed topological world sheets	Section 3.1
X, Y, \dots	World sheet (object of \mathcal{WSh})	Definition 3.1
\tilde{X}	Decorated double of a world sheet X	Section 3.3
$\tilde{\tilde{X}}$	Surface used in the definition of a world sheet	Definition 3.1
$b^{\text{in}}, b^{\text{out}}$	Set of in-, respectively, out-going boundary components	Definition 3.1
\mathcal{S}	Sewing of a world sheet	Definition 3.3
$\varpi = (\mathcal{S}, f)$	Morphism of \mathcal{WSh} (with f a homeomorphism)	Definition 3.4
$\text{fl}_{\mathcal{S}}(X)$	World sheet filled at \mathcal{S}	Definition 4.3
M_X	Connecting three-manifold	Equation (3.25)
$X_m, X_\eta, X_\Delta, X_\epsilon, X_{Bb}, X_{B(3)}, X_{B\eta}, X_{B\epsilon}$	Fundamental world sheets	Table 2/fig. 2
$X_p, X_{Bp}, X_{B\Delta}, X_{Bm}$	Some other simple world sheets	Table 2/fig. 3
\mathcal{C}	A modular tensor category (here, the chiral sectors)	Section 3.2
$tftc$	TFT functor from geometric category \mathcal{Gc} to \mathcal{Vect}	Section 3.2
$H_{\text{op}}, H_{\text{cl}}$	Open/closed state spaces	Section 3.3
B_l, B_r	Objects of \mathcal{C} such that H_{cl} is a retract of $B_l \times \overline{B_r}$	Section 3.3
K	Auxiliary object in \mathcal{C} appearing in the description of H_{cl} as a retract (cf. Lemma 4.12)	Section 3.3
w_K	Weighted sum of idempotents for subobjects of K	Equation (3.13) Equation (3.18)

H	Object in \mathcal{C} appearing in the description of TFT state spaces on surfaces with handles (cf. equation (3.15))	Equation (3.13)	p. 1300
$T_{\mathcal{C}}$	Canonical trivializing algebra (object in $\mathcal{C}\boxtimes\bar{\mathcal{C}}$)	Definition 4.8	p. 1327
$Z(A)$	Full centre of a symmetric special Frobenius algebra A in \mathcal{C} (object in $\mathcal{C}\boxtimes\bar{\mathcal{C}}$)	Definition 4.9	p. 1327
φ_{cl}^A	Isomorphism from H_{cl} to $Z(A)$	Equation (5.14)	p. 1353
One	Monoidal functor $\mathcal{WSh} \rightarrow \mathcal{Vect}$ with image $\mathbb{C} \xrightarrow{\text{id}_{\mathbb{C}}} \mathbb{C}$	Definition 3.6	p. 1300
Bl	Monoidal functor $\mathcal{WSh} \rightarrow \mathcal{Vect}$	Definition 3.7	p. 1305
Cor	Monoidal natural transformation from One to Bl	Section 3.4	p. 1311
\mathbb{N}	Natural isomorphism between functors of type Bl	Equation (3.42)	p. 1308
\mathbb{S}	Solution to the sewing constraints	Definition 3.14	p. 1309
$\mathbb{S}(\mathcal{C}, A)$	Tuple $(\mathcal{C}, A, Z(A), A \otimes K, K, e_Z, r_Z, Cor_A)$ furnishing a solution to the sewing constraints	Equation (4.47)	p. 1333
$A_{\mathbb{S}}$	Algebra of open states associated to \mathbb{S}	Equation (4.58)	p. 1338

Let us conclude this summary with the following two remarks. First, as already pointed out, even though in Sections 3–5 we work exclusively with topological world sheets, we do not only describe 2D topological CFTs. The reason is that the correlator Cor_X on a (topological) world sheet X is not itself a linear map between spaces of states, but rather it corresponds to a function on the moduli space of world sheets with metric (obtained as a section in a bundle of multilinear maps over the moduli space).

Second, in the framework of local quantum field theory on $1+1$ -dimensional Minkowski space a result analogous to Theorem 4.26 has been given in [17]; see Remark 4.27 (vi) below.

List of symbols. To achieve our goal we need to work with a variety of different structures. For the convenience of the reader, we collect some of them in table 1.

3 Open/closed sewing constraints

In this section we introduce the structures that we need for an algebraic formulation of the sewing constraints. These are the category \mathcal{WSh} of topological world sheets (Section 3.1), the 3D TFT obtained from a modular tensor category (Section 3.2), and a functor $B\ell$ from \mathcal{WSh} to \mathcal{Vect} which is constructed with the help of the 3D TFT (Section 3.3). The notion of sewing constraints, and of the equivalence of two solutions to these constraints, is discussed in Sections 3.4 and 3.5.

3.1 Oriented open/closed topological world sheets

We are concerned with CFT on oriented surfaces which may have empty or nonempty boundary. We call such surfaces oriented open/closed topological world sheets, or just world sheets, for short, and refer to CFT on such surfaces as *open/closed CFT*. An example of a topological world sheet is displayed in figure 1. Also recall from the introduction that when we want to describe correlators as actual functions, then we need to endow the world sheet in addition with a conformal structure and even a metric; this is discussed in Section 6.

As indicated in figure 1, a world sheet can have five types of boundary components. Four of them signify the presence of field insertions, while the fifth type describes a genuine physical boundary. These boundary types can

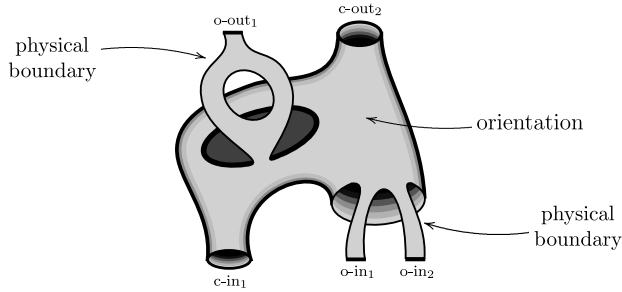

Figure 1: A topological world sheet.

be distinguished by their labelling: There are *in-going open state boundaries* (the intervals labelled $o\text{-in}_1$ and $o\text{-in}_2$ in the example given in figure 1), *out-going open state boundaries* ($o\text{-out}_1$ in the example), *in-going closed state boundaries* ($c\text{-in}_1$ in the example) and *out-going closed state boundaries* ($c\text{-out}_1$ in the example), and finally *physical boundaries*, which are unlabelled. The open and closed state boundaries are parametrized by intervals and circles, respectively. The physical boundaries are oriented, but not parametrized.

Geometrically the various boundary types can best be distinguished by describing the world sheet X as a quotient \dot{X} of a surface with boundary, \tilde{X} , by an orientation reversing involution ι . The surface shown in figure 1 is \dot{X} rather than \tilde{X} . With this description, a point p on the boundary of \dot{X} belongs to a physical boundary if its pre-image on \tilde{X} is a fixed point of ι , and otherwise to an open state boundary if its pre-images lie on a single connected component of $\partial\tilde{X}$, and to a closed state boundary if it has two pre-images on \tilde{X} lying on two distinct connected components of $\partial\tilde{X}$. We denote the number of in-going open state boundaries of X by $|o\text{-in}|$, etc. An important operation on world sheets is *sewing* [3, 18–20]: one specifies a set \mathcal{S} of pairs, consisting of an out-going and an in-going state boundary of the same type. From \mathcal{S} one can obtain a new world sheet $\mathcal{S}(X)$ by sewing, that is, by identifying, for each pair in \mathcal{S} , the two involved boundary components via the parametrization of the state boundaries. In the example in figure 1, some possible sewings are $\mathcal{S} = \{(o\text{-out}_1, o\text{-in}_1)\}$ and $\mathcal{S} = \{(c\text{-out}_1, c\text{-in}_1), (o\text{-out}_1, o\text{-in}_2)\}$.

Let us now describe these structures in a form amenable to our algebraic and combinatoric framework. To this end we introduce a symmetric strict monoidal category \mathcal{WSh} whose objects are oriented open/closed topological world sheets and whose morphisms are isomorphisms and sewings of such world sheets.

We denote by S^1 the unit circle $\{|z|=1\}$ in the complex plane, with counter-clockwise orientation. The map that assigns to a complex number its complex conjugate is denoted by $C: \mathbb{C} \rightarrow \mathbb{C}$.

Definition 3.1. An *oriented open/closed topological world sheet*, or *world sheet* for short, is a tuple

$$X \equiv (\tilde{X}, \iota_X, \delta_X, b_X^{\text{in}}, b_X^{\text{out}}, \text{or}_X) \tag{3.1}$$

consisting of:

- An oriented compact 2D topological manifold \tilde{X} . The (possibly empty) boundary $\partial\tilde{X}$ of \tilde{X} is oriented by the inward-pointing normal.
- A continuous orientation-reversing involution

$$\iota_X: \tilde{X} \rightarrow \tilde{X}. \tag{3.2}$$

- A continuous orientation-preserving map which parametrizes all boundary components of \tilde{X} , i.e., a map

$$\delta_X: \partial\tilde{X} \rightarrow S^1 \tag{3.3}$$

that is an isomorphism when restricted to a connected component of $\partial\tilde{X}$, and which treats boundary components that are mapped to each other by ι_X in a compatible manner, i.e., intertwines the involutions on \tilde{X} and \mathbb{C} , $\delta_X \circ \iota_X = C \circ \delta_X$.

- A partition of the set $\pi_0(\partial\tilde{X})$ of connected components of $\partial\tilde{X}$ into two subsets b_X^{in} and b_X^{out} (i.e., $b_X^{\text{in}} \cap b_X^{\text{out}} = \emptyset$ and $b_X^{\text{in}} \cup b_X^{\text{out}} = \pi_0(\partial\tilde{X})$). The subsets b_X^{in} and b_X^{out} are required to be fixed (as sets, not necessarily element-wise) under the involution ι_{X*} on $\pi_0(\partial\tilde{X})$ that is induced by ι_X .
- Denoting by $\tilde{\pi}_X: \tilde{X} \rightarrow \dot{X}$ the canonical projection to the quotient surface $\dot{X} := \tilde{X}/\langle \iota_X \rangle$, or_X is a global section of the bundle $\tilde{X} \xrightarrow{\tilde{\pi}_X} \dot{X}$, i.e., $\text{or}_X: \dot{X} \rightarrow \tilde{X}$ is a continuous function such that $\tilde{\pi}_X \circ \text{or}_X = \text{id}_{\dot{X}}$. In particular, a global section exists. We also demand that for a connected component c of $\partial\tilde{X}$, $\delta_X(\text{im } \text{or}_X \cap c)$ is either \emptyset , or S^1 , or the upper half circle $\{e^{i\theta} \mid 0 \leq \theta \leq \pi\}$.

Remark 3.2. (i) Since \tilde{X} is compact, the number $|\pi_0(\partial\tilde{X})|$ of connected components of $\partial\tilde{X}$ is finite. Also, the existence of a global section $\text{or}_X: \dot{X} \rightarrow \tilde{X}$ implies that \dot{X} is orientable, and in fact is provided with an orientation by demanding or_X to be orientation-preserving.

(ii) As mentioned at the beginning of this section, the boundary of the quotient surface \dot{X} can be divided into segments each of which is of one of five types. A point p on $\partial\dot{X}$ lies on a *physical boundary* iff p has a single

pre-image under $\tilde{\pi}_X$, which is hence a fixed point of ι_X . The point p lies on a *state boundary* if p has two pre-images under $\tilde{\pi}$. If both pre-images lie on the same connected component of $\partial\tilde{X}$, then p lies on an *open* state boundary, otherwise it lies on a *closed* state boundary. (Note that an open state boundary is a parametrized open interval on \tilde{X} .) Let a be a boundary component that contains a pre-image of p . If $a \in b^{\text{in}}$, then the state boundary containing p is *in-going*, otherwise it is *out-going*. Altogether we thus have five types: a region of $\partial\tilde{X}$ can be a physical boundary, or an in/out-going open, or an in/out-going closed state boundary.

World sheets are the *objects* of the category \mathcal{WSh} we wish to define. For *morphisms* we need the notion of sewing.

Definition 3.3. Let $X = (\tilde{X}, \iota, \delta, b^{\text{in}}, b^{\text{out}}, \text{or})$ be a world sheet.

- (i) *Sewing data* for X , or a *sewing* of X , is a (possibly empty) subset \mathcal{S} of $b^{\text{out}} \times b^{\text{in}}$ such that if $(a, b) \in \mathcal{S}$ then
 - \mathcal{S} does not contain any other pair of the form (a, \cdot) or (\cdot, b) ,
 - also $(\iota_*(a), \iota_*(b)) \in \mathcal{S}$,
 - the boundary component a has nonempty intersection with the image of or : $\dot{X} \rightarrow \tilde{X}$ iff the boundary component b does (i.e., \mathcal{S} preserves the orientation).
- (ii) For a sewing \mathcal{S} of X , the *sewn world sheet* $\mathcal{S}(X)$ is the tuple $\mathcal{S}(X) \equiv (\tilde{X}', \iota', \delta', b^{\text{in}'}, b^{\text{out}'}, \text{or}')$ that is obtained as follows. For $a \in \pi_0(\partial\tilde{X})$ denote by

$$\delta_a := \delta \Big|_{\partial\tilde{X}(a)} \quad (3.4)$$

the restriction of the boundary parametrization δ to the connected component a of $\partial\tilde{X}$; δ_a is an isomorphism. Then we set $\tilde{X}' := \tilde{X}/\sim$, where $\delta_a^{-1}(z) \sim \delta_b^{-1} \circ C(-z)$ for all $(a, b) \in \mathcal{S}$ and $z \in S^1$. Next, denote by $\pi_{\mathcal{S}, X}$ the projection from \tilde{X} to \tilde{X}' that takes a point of \tilde{X} to its equivalence class in \tilde{X}' . Then $\iota': \tilde{X}' \rightarrow \tilde{X}'$ is the unique involution such that $\iota' \circ \pi_{\mathcal{S}, X} = \pi_{\mathcal{S}, X} \circ \iota$. Further, δ' is the restriction of δ to $\partial\tilde{X}'$, $b^{\text{out}'} = \{a \in b^{\text{out}} \mid (a, \cdot) \notin \mathcal{S}\}$, $b^{\text{in}'} = \{b \in b^{\text{in}} \mid (\cdot, b) \notin \mathcal{S}\}$, and or' is the unique continuous section of $\tilde{X}' \xrightarrow{\tilde{\pi}_{X'}} \dot{X}'$ such that the image of or' coincides with the image of $\pi_{\mathcal{S}, X} \circ \text{or}$.

One can verify that the procedure in (ii) does indeed define a world sheet.

Definition 3.4. Let X and Y be two world sheets.

- (i) A *homeomorphism of world sheets* is a homeomorphism $f: \tilde{X} \rightarrow \tilde{Y}$ that is compatible with all chosen structures on \tilde{X} , i.e., with orientation,

involution and boundary parametrization. That is, f satisfies

$$f \circ \iota_X = \iota_Y \circ f, \quad \delta_Y \circ f = \delta_X, \quad f_* b_X^{\text{in/out}} = b_Y^{\text{in/out}} \tag{3.5}$$

(where $f_*: \pi_0(\partial\tilde{X}) \rightarrow \pi_0(\partial\tilde{Y})$ is the isomorphism induced by f), and the image of $f \circ \text{or}_X$ coincides with the image of or_Y .

- (ii) A *morphism* $\varpi: X \rightarrow Y$ is a pair $\varpi = (\mathcal{S}, f)$ where \mathcal{S} are sewing data for X and $f: \widetilde{\mathcal{S}(X)} \rightarrow \tilde{Y}$ is a homeomorphism of world sheets.
- (iii) The set of all morphisms from X to Y is denoted by $\text{Hom}(X, Y)$.

Given two morphisms $\varpi = (\mathcal{S}, f): X \rightarrow Y$ and $\varpi' = (\mathcal{S}', g): Y \rightarrow Z$, the composition $\varpi' \circ \varpi$ is defined as follows. The union $\mathcal{S}'' = \mathcal{S} \cup (f \circ \pi_{\mathcal{S}, X})^{-1}(\mathcal{S}')$ is again a sewing of X . Furthermore there exists a unique isomorphism $h: \widetilde{\mathcal{S}''(X)} \rightarrow \tilde{Z}$ such that the diagram

$$\begin{array}{ccccccc}
 \tilde{X} & \xrightarrow{\pi_{\mathcal{S}, X}} & \widetilde{\mathcal{S}(X)} & \xrightarrow{f} & \tilde{Y} & \xrightarrow{\pi_{\mathcal{S}', Y}} & \widetilde{\mathcal{S}'(Y)} & \xrightarrow{g} & \tilde{Z} \\
 \downarrow \pi_{\mathcal{S}'', X} & & & & & & & & \\
 \widetilde{\mathcal{S}''(X)} & & & & & \nearrow h & & &
 \end{array} \tag{3.6}$$

commutes. We define the composition $\circ: \text{Hom}(Y, Z) \times \text{Hom}(X, Y) \rightarrow \text{Hom}(X, Z)$ as

$$(\mathcal{S}', g) \circ (\mathcal{S}, f) = (\mathcal{S}'', h). \tag{3.7}$$

One verifies that the composition is associative. The identity morphism on X is the pair $\text{id}_X = (\emptyset, \text{id}_{\tilde{X}})$.

Finally, we define a monoidal structure on \mathcal{WSh} by taking the tensor product to be the disjoint union, both on world sheets and on morphisms, and the unit object to be the empty set. We also define the isomorphism $c_{X, Y}: X \sqcup Y \rightarrow Y \sqcup X$ to be the homeomorphism that exchanges the two factors of the disjoint union. In this way, \mathcal{WSh} becomes a symmetric strict monoidal category.

- Remark 3.5.**
- (i) The set of morphisms from $\mathbf{1}$ (the empty set) to any world sheet X with $\tilde{X} \neq \emptyset$ is empty. Thus there does not exist a duality on \mathcal{WSh} , nor is there an initial or a final object in \mathcal{WSh} .
 - (ii) What we refer to as physical boundaries of \tilde{X} are called “boundary sector boundaries” in [21], “free boundaries” in [22, 23], “coloured boundaries” in [24] and “constrained boundaries” in [25].
 - (iii) \mathcal{WSh} is different from the category of open/closed 2D cobordisms considered in the context of 2D open/closed TFT in [21–25]. There, objects are disjoint unions of circles and intervals, and morphisms are equivalence classes of cobordisms between these unions. One can also consider 2D open/closed cobordisms as a 2-category as in [26, 27].

Then objects are defined as just mentioned, 1-morphisms are surfaces embedded in \mathbb{R}^3 which have the union of circles and intervals as boundary, and 2-morphisms are homeomorphisms between these surfaces. The 1- and 2-morphisms in this definition correspond to the objects and some of the morphisms in \mathcal{WSh} , but they do not include the sewing operation.

From Section 3.3 on we will, when drawing a world sheet X , usually only draw the surface \dot{X} , give the orientation on \dot{X} and indicate the decomposition of $\partial\dot{X}$ into segments as well as the type of each segment (see Remark 3.2 (ii)). As an example, consider the surface \tilde{X} given by a sphere with six small equally spaced holes along a great circle,

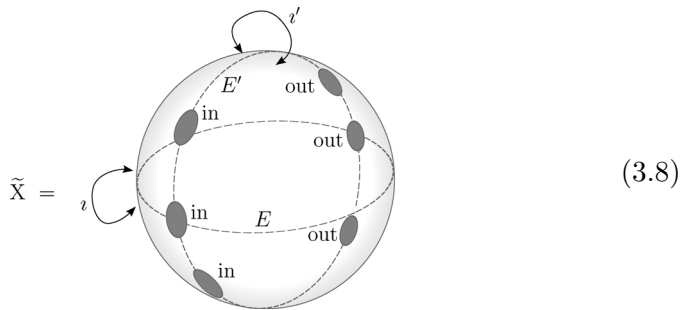

In the figure it is also indicated how $\pi_0(\partial\tilde{X})$ is partitioned into b^{in} and b^{out} . In addition two great circles E and E' are drawn. Denote by ι the reflection with respect to the plane intersecting \tilde{X} at E and ι' the reflection for the plane intersecting at E' . We obtain two world sheets X and X' which only differ in their involution and orientation,

$$X = (\tilde{X}, \iota, \delta, b^{\text{in}}, b^{\text{out}}, \text{or}) \quad \text{and} \quad X' = (\tilde{X}, \iota', \delta, b^{\text{in}}, b^{\text{out}}, \text{or}'). \tag{3.9}$$

The orientation or is fixed by requiring its image in \tilde{X} to be the half-sphere above E (say), together with E , and for or' one can take the half-sphere in front of E' . The quotients \dot{X} and \dot{X}' for these two world sheets then look as follows.

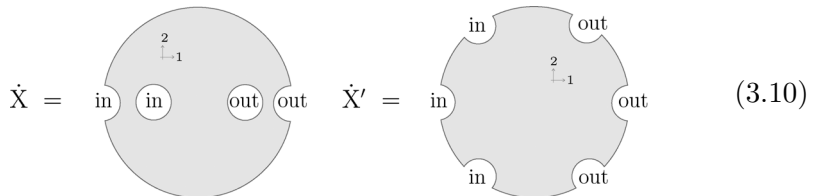

Note that \dot{X} and \dot{X}' have different topology.

3.2 Modular tensor categories and 3D TFT

The starting point of the algebraic formulation of the sewing constraints is a *modular tensor category* \mathcal{C} . By this we mean a strict monoidal category \mathcal{C} such that

- (i) The tensor unit is simple.
- (ii) \mathcal{C} is abelian, \mathbb{C} -linear and semisimple.
- (iii) \mathcal{C} is ribbon:⁵ There are families $\{c_{U,V}\}$ of braiding, $\{\theta_U\}$ of twist, and $\{d_U, b_U\}$ of evaluation and coevaluation morphisms satisfying the usual properties.
- (iv) \mathcal{C} is Artinian (or “finite”), i.e., the number of isomorphism classes of simple objects is finite.
- (v) The braiding is maximally nondegenerate: the numerical matrix s with entries

$$s_{i,j} := (d_{U_j} \otimes \tilde{d}_{U_i}) \circ [\text{id}_{U_j^\vee} \otimes (c_{U_i, U_j} \circ c_{U_j, U_i}) \otimes \text{id}_{U_i^\vee}] \circ (\tilde{b}_{U_j} \otimes b_{U_i}) \quad (3.11)$$

is invertible.

Here we denote by $\{U_i \mid i \in \mathcal{I}\}$ a (finite) set of representatives of isomorphism classes of simple objects; we also take $U_0 := \mathbf{1}$ as the representative for the class of the tensor unit. The properties we demand of a modular tensor category are slightly stronger than in the original definition in [15].

It is worth mentioning that every ribbon category is *sovereign*, i.e., besides the right duality given by $\{d_U, b_U\}$ there is also a left duality (with evaluation and coevaluation morphisms to be denoted by $\{\tilde{d}_U, \tilde{b}_U\}$), which coincides with the left duality in the sense that ${}^\vee U = U^\vee$ and ${}^\vee f = f^\vee$.

We also make use of the following notions. An *idempotent* is an endomorphism p such that $p \circ p = p$. A *retract* of an object W is a triple (V, e, r) with $e \in \text{Hom}(V, W)$, $r \in \text{Hom}(W, V)$ and $r \circ e = \text{id}_V$. Note that $e \circ r$ is an idempotent in $\text{End}(W)$. Because of property (ii) above, a modular tensor category is idempotent-complete, i.e., every idempotent is split and thus gives rise to a retract.

⁵Besides the qualifier “ribbon” [28], which emphasizes the fact that (see e.g., [29] Chapter XIV.5.1) the category of ribbons is universal for this class of categories, also the terms “tortile” [30] and “balanced rigid braided” are in use.

The *dual category* $\overline{\mathcal{C}}$ of a monoidal category (\mathcal{C}, \otimes) is the monoidal category $(\mathcal{C}^{\text{opp}}, \otimes)$. More concretely, when marking quantities in $\overline{\mathcal{C}}$ by an overline, we have

$$\begin{aligned} \text{Objects : } & \text{Obj}(\overline{\mathcal{C}}) = \overline{\text{Obj}(\mathcal{C})}, \text{ i.e., } \overline{U} \in \text{Obj}(\overline{\mathcal{C}}) \quad \text{iff} \quad U \in \overline{\text{Obj}(\mathcal{C})}, \\ \text{Morphisms : } & \overline{\text{Hom}}(\overline{U}, \overline{V}) = \overline{\text{Hom}(U, V)}, \\ \text{Composition : } & \overline{f \circ g} = \overline{g \circ f}, \\ \text{Tensor product : } & \overline{U} \otimes \overline{V} = \overline{U \otimes V}, \quad \overline{f} \otimes \overline{g} = \overline{f \otimes g}, \\ \text{Tensor unit : } & \overline{\mathbf{1}} = \mathbf{1}. \end{aligned} \tag{3.12}$$

If \mathcal{C} is in addition ribbon, then we can turn $\overline{\mathcal{C}}$ into a ribbon category by taking $\overline{c}_{\overline{U}, \overline{V}} := (\overline{c_{U, V}})^{-1}$ and $\overline{\theta}_{\overline{U}} := (\overline{\theta_U^{-1}})$ for braiding and twist, and $\overline{b}_{\overline{U}} := (\overline{b_U})$, etc., for the dualities. More details can be found e.g., in Section 6.2 of [31].

Alternatively, as in [32, Section 7] one can define a category $\widetilde{\mathcal{C}}$ identical to \mathcal{C} as a monoidal category, but with braiding and twist replaced by their inverses. As \mathcal{C} is ribbon, we have a duality compatible with braiding and twist, and it turns out that $\overline{\mathcal{C}}$ and $\widetilde{\mathcal{C}}$ are equivalent as ribbon categories. For our purposes it is more convenient to work with $\overline{\mathcal{C}}$.

Let $\mathcal{C} \boxtimes \overline{\mathcal{C}}$ be the product of \mathcal{C} and $\overline{\mathcal{C}}$ in the sense of enriched (over \mathcal{Vect}) categories, i.e., the modular tensor category obtained by idempotent completion of the category whose objects are pairs of objects of \mathcal{C} and $\overline{\mathcal{C}}$ and whose morphism spaces are tensor products over \mathbb{C} of the morphism spaces of \mathcal{C} and $\overline{\mathcal{C}}$ (see [31, Definition 6.1] for more details).

Next we briefly state our conventions for the 3D TFT that we will use; for more details, see e.g., [4, 15, 16] or Section 2 of [1].

Given a modular tensor category \mathcal{C} , the construction of [15] allows one to construct a 3D TFT, that is, a monoidal functor $tft_{\mathcal{C}}$ from a geometric category $\mathcal{G}_{\mathcal{C}}$ to \mathcal{Vect} . The geometric category is defined as follows. An object E of $\mathcal{G}_{\mathcal{C}}$ is an *extended surface*; an oriented, closed surface with a finite number of marked arcs labelled by pairs (U, ϵ) , where $U \in \text{Obj}(\mathcal{C})$ and $\epsilon \in \{+, -\}$, and with a choice of Lagrangian subspace $\lambda \subset H^1(E, \mathbb{R})$. Following [33], we define a morphism $a: E \rightarrow F$ to be one of two types:

(i) a homeomorphism of extended surfaces (a homeomorphism of the underlying surfaces preserving orientation, marked arcs and Lagrangian subspaces);

(ii) a triple (M, n, h) where M is a cobordism of extended surfaces, $h: \partial M \rightarrow \overline{E} \sqcup F$ is a homeomorphism of extended surfaces, and $n \in \mathbb{Z}$ is a weight which

is needed (see [15, Section IV.9]) to make $tft_{\mathcal{C}}$ anomaly-free. The cobordism M can contain ribbons, which are labelled by objects of \mathcal{C} and coupons, which are labelled by morphisms of \mathcal{C} . Ribbons end on coupons or on the arcs of E and F . We denote by h^- and h^+ the restrictions of h to the incoming component ∂_-M of ∂M (the pre-image of \bar{E} under h) and the out-going component ∂_+M (the pre-image of F).

Two cobordisms (M, n, h) and (M', n, h') from E to F are *equivalent* iff there exists a homeomorphism $\varphi: M \rightarrow M'$ taking ribbons and coupons of M to identically labelled ribbons and coupons of M' and obeying $h = h' \circ \varphi$. The functor $tft_{\mathcal{C}}$ is constant on equivalence classes of cobordisms.

Composition of two morphisms is defined as follows: for $f: E \rightarrow E'$ and $g: E' \rightarrow F$ both homeomorphisms, the composition is simply the composition $g \circ f: E \rightarrow F$ of maps. Morphisms $(M_1, n_1, h_1): E \rightarrow E'$ and $(M_2, n_2, h_2): E' \rightarrow F$ are composed to $(M, n, h): E \rightarrow F$, where M is the cobordism obtained by identifying points on ∂_+M_1 with points on ∂_-M_2 using the homeomorphism $(h_2^-)^{-1} \circ h_1^+$. The homeomorphism $h: \partial M \rightarrow \bar{E} \sqcup F$ is defined by $h|_{\partial_-M} := h_1^-, h|_{\partial_+M} := h_2^+$, and the integer n is computed from the two morphisms $E \rightarrow E'$ and $E' \rightarrow F$ according to an algorithm described in [15, Section IV.9]. Composition of a homeomorphism $f: E \rightarrow E'$ and a cobordism $(M, n, g): E' \rightarrow F$ is the cobordism $(M, n, h): E \rightarrow F$, where $h: \partial M \rightarrow \bar{E} \sqcup F$ is defined as $h|_{\partial_-M} := f^{-1} \circ g^-, h|_{\partial_+M} := g^+$. The category $\mathcal{G}_{\mathcal{C}}$ is a strict monoidal category with monoidal structure given by disjoint union, and the empty set (interpreted as an extended surface) as the tensor unit.

Given a modular tensor category \mathcal{C} with label set \mathcal{I} for representatives of the simple objects, consider the objects

$$K := \bigoplus_{k \in \mathcal{I}} U_k \quad \text{and} \quad H := \bigoplus_{k \in \mathcal{I}} U_k \otimes U_k^\vee \tag{3.13}$$

in \mathcal{C} . Note that we can choose a nonzero epimorphism r_H from $K \otimes K^\vee = \bigoplus_{i, j \in \mathcal{I}} U_i \otimes U_j^\vee$ to H . The dimension of the category \mathcal{C} is defined to be that of the object H ,

$$\text{Dim}(\mathcal{C}) = \dim(H) = \sum_{k \in \mathcal{I}} \dim(U_k)^2. \tag{3.14}$$

The objects H and K are useful to describe the state spaces of the 3D TFT constructed from \mathcal{C} : let E be a connected extended surface of genus g with marked points $\{(V_i, \varepsilon_i) \mid i = 1, \dots, m\}$ where $\varepsilon_i \in \{\pm 1\}$. By construction [15, Section IV.2.1], the state space $tft_{\mathcal{C}}(E)$ is isomorphic to

$$\text{Hom} \left(\bigotimes_{i=1}^m V_i^{\varepsilon_i} \otimes H^{\otimes g}, \mathbf{1} \right), \tag{3.15}$$

where $V_i^+ = V_i$ and $V_i^- = V_i^\vee$. An isomorphism can be given by choosing a handle body T with $\partial T = E$, inserting a coupon labelled by an element in (3.15) such that the V_i -ribbons starting at the boundary arcs are joined to the in-going side of the coupon. For each H -ribbon attached to the coupon insert the restriction morphism r_H from $K \otimes K^\vee$ to H and a K -ribbon starting and ending at this restriction morphism, so that one K -ribbon passes through each of the handles of T . For example, if E is a genus-2 surface with marked arcs labelled by $(U, +)$, $(V, -)$ and $(W, +)$, then we have $f \in \text{Hom}(U \otimes V^\vee \otimes W \otimes H \otimes H, \mathbf{1})$ and the relevant handle body is

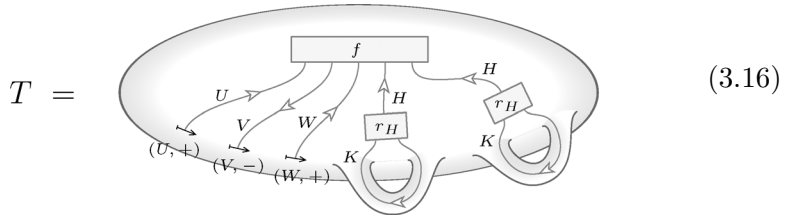

We call the cobordism from \emptyset to E obtained in this way a *handle body for E* and denote it by $T(f)$, where f is the element of (3.15) labelling the coupon. Then

$$f \mapsto \text{tft}_{\mathcal{C}}(T(f)) \tag{3.17}$$

is an isomorphism from (3.15) to the space of linear maps from \mathbb{C} to $\text{tft}_{\mathcal{C}}(E)$, which we may identify with $\text{tft}_{\mathcal{C}}(E)$. For nonconnected E one defines $\text{tft}_{\mathcal{C}}(E)$ as the tensor product of the state spaces of its connected components.

Later on we will need the morphism $w_K \in \text{Hom}(K, K)$ given by

$$w_K := \frac{1}{\text{Dim}(\mathcal{C})} \sum_{k \in \mathcal{I}} \dim(U_k) P_k, \tag{3.18}$$

where $P_k \in \text{Hom}(K, K)$ is the idempotent projecting onto the subobject U_k of K . Note that

$$\text{tr}(w_K) = \frac{1}{\text{Dim}(\mathcal{C})} \sum_{k \in \mathcal{I}} \dim(U_k)^2 = 1. \tag{3.19}$$

Let V be an object of \mathcal{C} and let $e_{k\alpha} \in \text{Hom}(U_k, V)$ and $r_{k\alpha} \in \text{Hom}(V, U_k)$ be embedding and restriction morphisms of the various subobjects U_k , so that

we have $\sum_{k,\alpha} e_{k\alpha} \circ r_{k\alpha} = \text{id}_V$. The following identity holds:

$$\begin{array}{c} V \\ | \\ \text{---} \circ \text{---} \\ | \\ V \end{array} \quad = \quad \sum_{\alpha} \begin{array}{c} V \\ | \\ \boxed{e_{0\alpha}} \\ | \\ \boxed{r_{0\alpha}} \\ | \\ V \end{array} \quad (3.20)$$

To see this, note that (by the properties of the matrix s for a modular tensor category)

$$\frac{1}{\text{Dim}(\mathcal{C})} \sum_l \dim(U_l) \begin{array}{c} v \\ | \\ \boxed{e_{k\alpha}} \\ | \\ \text{---} \circ \text{---} \\ | \\ \boxed{r_{k\alpha}} \\ | \\ v \end{array} = \frac{1}{\text{Dim}(\mathcal{C})} \sum_l s_{0,l} \frac{s_{k,l}}{s_{0,k}} \begin{array}{c} v \\ | \\ \boxed{e_{k\alpha}} \\ | \\ \uparrow U_k \\ | \\ \boxed{r_{k\alpha}} \\ | \\ v \end{array} = \delta_{k,0} e_{k\alpha} \circ r_{k\alpha}, \quad (3.21)$$

which implies that when expanding id_V into a sum over the identity morphisms for the simple subobjects U_k of V , only $U_0 = \mathbf{1}$ gives a nonzero contribution, so that one arrives at (3.20).

3.3 Assigning the space of blocks to a world sheet

The sewing constraints will be formulated as a natural transformation between two symmetric monoidal functors One and $B\ell$ from \mathcal{WSh} to the category \mathcal{Vect} of finite-dimensional complex vector spaces. The first one is introduced in

Definition 3.6. The functor One from \mathcal{WSh} to \mathcal{Vect} is given by setting

$$One(X) := \mathbb{C} \quad \text{and} \quad One(\varpi) := \text{id}_{\mathbb{C}} \quad (3.22)$$

for objects X and morphisms ϖ of \mathcal{WSh} , respectively.

The second functor, $B\ell \equiv B\ell(\mathcal{C}, H_{\text{op}}, H_{\text{cl}}, B_l, B_r, e, r)$ is obtained as follows. We first assign to a world sheet X an extended surface \widehat{X} , called the decorated double of X ; to \widehat{X} we can apply the 3D TFT functor $tft_{\mathcal{C}}$ obtained

from a modular tensor category \mathcal{C} ; finally we select a suitable subspace of $tft_{\mathcal{C}}(\widehat{X})$. Analogous steps must be performed for morphisms. The precise description of these manipulations will take up most of the rest of this section.

We will call the vector space that $B\ell$ assigns to a world sheet X the *space of blocks for X* . It depends on the following data:

- A modular tensor category \mathcal{C} .
- A nonzero object H_{op} of \mathcal{C} , called the *open state space*, and a nonzero object H_{cl} of $\mathcal{C} \boxtimes \overline{\mathcal{C}}$, called the *closed state space*.
- Auxiliary objects B_l and B_r of \mathcal{C} , together with morphisms $e \in \text{Hom}_{\mathcal{C} \boxtimes \overline{\mathcal{C}}}(H_{\text{cl}}, B_l \times \overline{B_r})$ and $r \in \text{Hom}_{\mathcal{C} \boxtimes \overline{\mathcal{C}}}(B_l \times \overline{B_r}, H_{\text{cl}})$ such that (H_{cl}, e, r) is a retract of $B_l \times \overline{B_r}$.

At the end of this section we will show that different realizations of H_{cl} as a retract lead to equivalent functors $B\ell$.

As a start, from a world sheet X we construct an extended surface $\widehat{X} \equiv \widehat{X}(H_{\text{op}}, B_l, B_r)$, which we call the *decorated double of X* . It is obtained by gluing a standard disk with a marked arc to each boundary component of \widetilde{X} . Let \vec{D} be the unit disk $\{|z| \leq 1\} \subset \mathbb{C}$ with a small arc embedded on the real axis, centred at 0 and pointing towards +1. The orientation of \vec{D} is that induced by \mathbb{C} . Then we set

$$\widehat{X} := \widetilde{X} \sqcup (\pi_0(\partial\widetilde{X}) \times \vec{D}) / \sim, \quad (3.23)$$

where the equivalence relation divided out specifies the gluing in terms of the boundary parametrization according to

$$(a, z) \sim \delta_a^{-1} \circ C(-z) \quad \text{for } a \in \pi_0(\partial\widetilde{X}), \quad z \in \partial\vec{D}. \quad (3.24)$$

(Here the complex conjugation C is needed for \widehat{X} to be oriented.) Further, for $a \in \pi_0(\partial\widetilde{X})$ the arc on the disk $\{a\} \times \vec{D}$ is marked by (U_a, ε_a) , where $U_a \in \{H_{\text{op}}, B_l, B_r\}$ and $\varepsilon_a \in \{\pm\}$ are chosen as follows:

- If $\iota_*(a) = a$, then $U_a = H_{\text{op}}$. If in addition $a \in b^{\text{in}}$, then $\varepsilon_a = +$, otherwise $\varepsilon_a = -$.
- If $\iota_*(a) \neq a$ and the boundary component a lies in the image of the orientation or, then $U_a = B_l$. If in addition $a \in b^{\text{in}}$, then $\varepsilon_a = +$, otherwise $\varepsilon_a = -$.
- If $\iota_*(a) \neq a$ and the boundary component a does not lie in the image of the orientation or, then $U_a = B_r$. If in addition $a \in b^{\text{in}}$, then $\varepsilon_a = -$, otherwise $\varepsilon_a = +$.

Note that the involution $\iota: \tilde{X} \rightarrow \tilde{X}$ can be extended to an involution $\hat{\iota}: \hat{X} \rightarrow \hat{X}$ by taking it to be complex conjugation on each of the disks \bar{D} glued to \tilde{X} . Finally, to turn \hat{X} into an extended surface we need to specify a Lagrangian subspace $\lambda \subset H^1(\hat{X}, \mathbb{R})$. To do this we start by taking the *connecting manifold*

$$M_X = \hat{X} \times [-1, 1] / \sim, \quad \text{where for all } x \in \hat{X}, \quad (x, t) \sim (\hat{\iota}(x), -t), \quad (3.25)$$

which has the property that $\partial M_X = \hat{X}$. Then λ is the kernel of the resulting homomorphism $H^1(\hat{X}, \mathbb{R}) \rightarrow H^1(M_X, \mathbb{R})$. We refer to [2] Appendix B.1, for more details.

As an example, consider the world sheet X in (3.9). In this case the decorated double is given by a sphere with six marked arcs,

$$\hat{X}(H_{op}, B_l, B_r) =$$

$$(3.26)$$

The 3D TFT assigns to the extended surface $\hat{X} \equiv \hat{X}(H_{op}, B_l, B_r)$ a complex vector space $tft_{\mathbb{C}}(\hat{X})$. In order to define the action of the functor $B\ell$ on objects of \mathcal{WSh} , one needs to reduce the auxiliary object $B_l \times \bar{B}_r$ to its retract H_{cl} in $\mathcal{C} \boxtimes \bar{\mathcal{C}}$ (this will also show that the precise choice of objects B_l and B_r is immaterial). To this end we first introduce a certain linear map between the vector spaces assigned to decorated doubles. More specifically, given a world sheet X , a choice of objects $H_{op}, B_l, B_r, H'_{op}, B'_l, B'_r$ and morphisms $o^{in} \in \text{Hom}_{\mathcal{C}}(H'_{op}, H_{op})$ and $o^{out} \in \text{Hom}_{\mathcal{C}}(H_{op}, H'_{op})$, as well as $c^{in} \in \text{Hom}_{\mathcal{C} \boxtimes \bar{\mathcal{C}}}(B'_l \times \bar{B}'_r, B_l \times \bar{B}_r)$ and $c^{out} \in \text{Hom}_{\mathcal{C} \boxtimes \bar{\mathcal{C}}}(B_l \times \bar{B}_r, B'_l \times \bar{B}'_r)$, we will introduce a linear map

$$F_X(o^{in}, o^{out}, c^{in}, c^{out}) : \quad tft_{\mathbb{C}}(\hat{X}(H_{op}, B_l, B_r)) \rightarrow tft_{\mathbb{C}}(\hat{X}(H'_{op}, B'_l, B'_r)). \quad (3.27)$$

The slightly tedious definition proceeds as follows. Since the morphism spaces of $\mathcal{C} \boxtimes \bar{\mathcal{C}}$ are given in terms of tensor products, we can write

$$c^{in} = \sum_{\alpha \in I^{in}} c_{l,\alpha}^{in} \otimes c_{r,\alpha}^{in} \quad \text{and} \quad c^{out} = \sum_{\beta \in I^{out}} c_{l,\beta}^{out} \otimes c_{r,\beta}^{out} \quad (3.28)$$

with suitable morphisms $c_{l,\alpha}^{in} \in \text{Hom}_{\mathcal{C}}(B'_l, B_l)$, $c_{r,\alpha}^{in} \in \text{Hom}_{\mathcal{C}}(B_r, B'_r)$, $c_{l,\beta}^{out} \in \text{Hom}_{\mathcal{C}}(B_l, B'_l)$ and $c_{r,\beta}^{out} \in \text{Hom}_{\mathcal{C}}(B'_r, B_r)$, and index sets I^{in} and I^{out} . Denote

by S^{in} all in-going closed state boundaries of X , i.e., $S^{\text{in}} = \{a \in b^{\text{in}} \mid \iota_*(a) \neq a\}$, and similarly $S^{\text{out}} = \{a \in b^{\text{out}} \mid \iota_*(a) \neq a\}$. We say that a map $\alpha: S^{\text{in}} \rightarrow I^{\text{in}}$ or $\alpha: S^{\text{out}} \rightarrow I^{\text{out}}$ is ι -invariant iff $\alpha \circ \iota = \alpha$. Given two ι -invariant maps $\alpha: S^{\text{in}} \rightarrow I^{\text{in}}$ and $\beta: S^{\text{out}} \rightarrow I^{\text{out}}$, we construct a cobordism

$$N_X(\alpha, \beta) : \widehat{X}(H_{\text{op}}, B_l, B_r) \rightarrow \widehat{X}(H'_{\text{op}}, B'_l, B'_r) \tag{3.29}$$

as follows. Start from the cylinder $\widehat{X}(H_{\text{op}}, B_l, B_r) \times [0, 1]$. On each vertical ribbon insert a coupon. Relabel the half of the vertical ribbon between the coupon and the out-going boundary component $\widehat{X}(H_{\text{op}}, B_l, B_r) \times \{1\}$ from H_{op}, B_l, B_r to $H'_{\text{op}}, B'_l, B'_r$, respectively. The coupon attached to a ribbon starting on the disk $\{a\} \times \vec{D} \subset \widehat{X}(H_{\text{op}}, B_l, B_r)$ for some $a \in \pi_0(\partial\widehat{X})$ is labelled by $o^{\text{in}}, c^{\text{in}}_{l,\alpha(a)}$ or $c^{\text{in}}_{r,\alpha(a)}$ if $a \in b^{\text{in}}$, and $o^{\text{out}}, c^{\text{out}}_{l,\beta(a)}$ or $c^{\text{out}}_{r,\beta(a)}$ if $a \in b^{\text{out}}$. Which of the three morphisms one must choose is determined in an obvious manner by the labels of the ribbons attached to the coupon.

For the world sheet X from example (3.9), the cobordism $N_X(\alpha, \beta)$ looks as follows.

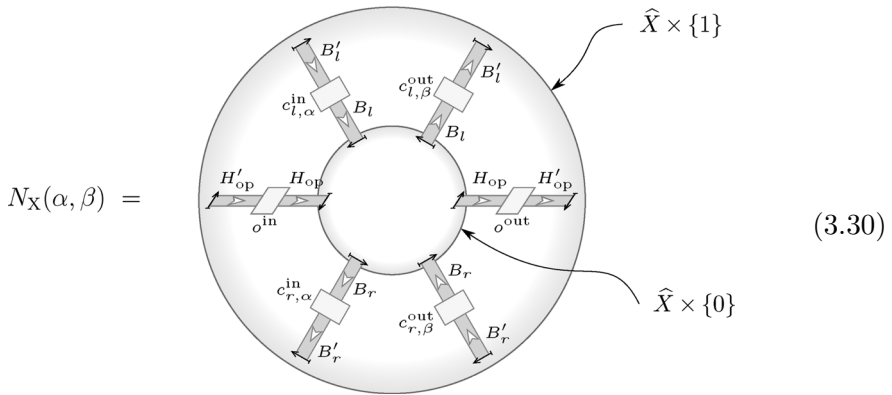

The linear map $F_X(o^{\text{in}}, o^{\text{out}}, c^{\text{in}}, c^{\text{out}}): \text{tftc}(\widehat{X}(H_{\text{op}}, B_l, B_r)) \rightarrow \text{tftc}(\widehat{X}(H'_{\text{op}}, B'_l, B'_r))$ is given by

$$F_X(o^{\text{in}}, o^{\text{out}}, c^{\text{in}}, c^{\text{out}}) = \sum_{\alpha, \beta} \text{tftc}(N_X(\alpha, \beta)), \tag{3.31}$$

where the sum is over all ι -invariant functions $\alpha: S^{\text{in}} \rightarrow I^{\text{in}}$ and $\beta: S^{\text{out}} \rightarrow I^{\text{out}}$. This definition is independent of the choice of decomposition (3.28) because the functor tftc is multilinear in the labels of the coupons.

Suppose we are in addition given objects $H''_{\text{op}}, B''_l, B''_r$ and morphisms $p^{\text{in}} \in \text{Hom}_{\mathcal{C}}(H''_{\text{op}}, H'_{\text{op}})$, $p^{\text{out}} \in \text{Hom}_{\mathcal{C}}(H'_{\text{op}}, H''_{\text{op}})$ as well as $d^{\text{in}} \in \text{Hom}_{\mathcal{C} \boxtimes \bar{\mathcal{C}}}$

$(B_l'' \times \overline{B_r}'', B_l' \times \overline{B_r}')$ and $d^{\text{out}} \in \text{Hom}_{\mathcal{C} \boxtimes \overline{\mathcal{C}}}(B_l' \times \overline{B_r}', B_l'' \times \overline{B_r}'')$. Using the definition of F_X and functoriality of $tft_{\mathcal{C}}$ one can verify that

$$\begin{aligned} &F_X(p^{\text{in}}, p^{\text{out}}, d^{\text{in}}, d^{\text{out}}) F_X(o^{\text{in}}, o^{\text{out}}, c^{\text{in}}, c^{\text{out}}) \\ &= F_X(o^{\text{in}} \circ p^{\text{in}}, p^{\text{out}} \circ o^{\text{out}}, c^{\text{in}} \circ d^{\text{in}}, d^{\text{out}} \circ c^{\text{out}}). \end{aligned} \tag{3.32}$$

We have now gathered all the ingredients for defining the functor $B\ell$ on objects of \mathcal{WSh} . Denote by $P_X = P_X(H_{\text{op}}, H_{\text{cl}}, B_l, B_r, e, r)$ the endomorphism of $tft_{\mathcal{C}}(\widehat{X}(H_{\text{op}}, B_l, B_r))$ that is given by

$$P_X := F_X(\text{id}_{H_{\text{op}}}, \text{id}_{H_{\text{op}}}, e \circ r, e \circ r) \tag{3.33}$$

with morphisms e and r such that (H_{cl}, e, r) is a retract of $B_l \times \overline{B_r}$. Equation (3.32) immediately implies that $P_X P_X = P_X$, i.e., P_X is an idempotent.

Now we define, for a world sheet X ,

$$B\ell(X) := \text{Im}(P_X) \subseteq tft_{\mathcal{C}}(\widehat{X}), \tag{3.34}$$

where we abbreviate $B\ell \equiv B\ell(\mathcal{C}, H_{\text{op}}, H_{\text{cl}}, B_l, B_r, e, r)$, $P_X = P_X(H_{\text{op}}, H_{\text{cl}}, B_l, B_r, e, r)$ as well as $\widehat{X} \equiv \widehat{X}(H_{\text{op}}, B_l, B_r)$.

Next we turn to the definition of $B\ell(\varpi)$ for a morphism $\varpi = (\mathcal{S}, f) \in \text{Hom}(X, Y)$ of \mathcal{WSh} . First note that we can extend the isomorphism $f: \widehat{\mathcal{S}}(\widehat{X}) \rightarrow \widetilde{Y}$ to an isomorphism $\hat{f}: \widehat{\mathcal{S}}(\widehat{X}) \rightarrow \widehat{Y}$ by taking it to be the identity map on the disks \vec{D} which are glued to the boundary components of $\widehat{\mathcal{S}}(\widehat{X})$ and \widehat{Y} . To \hat{f} the 3D TFT assigns an isomorphism $tft_{\mathcal{C}}(\hat{f}): tft_{\mathcal{C}}(\widehat{\mathcal{S}}(\widehat{X})) \rightarrow tft_{\mathcal{C}}(\widehat{Y})$. Next we construct a morphism $\hat{\mathcal{S}}: \widehat{X} \rightarrow \widehat{\mathcal{S}}(\widehat{X})$ as a cobordism. It is given by the cylinder over \widehat{X} modulo an equivalence relation,

$$\hat{\mathcal{S}} := \widehat{X} \times [0, 1] / \sim. \tag{3.35}$$

The equivalence relation identifies certain points on the boundary $\widehat{X} \times \{1\}$ of $\widehat{X} \times [0, 1]$. Namely, for each pair $(a, b) \in \mathcal{S}$ and for all $z \in \vec{D}$ we identify the points $(a, z, 1) \in \{a\} \times \vec{D} \times \{1\}$ and $(b, C(-z), 1) \in \{b\} \times \vec{D} \times \{1\}$. In terms of the morphisms \hat{f} and $\hat{\mathcal{S}}$ we now define, for $\varpi = (\mathcal{S}, f)$,

$$B\ell(\varpi) := tft_{\mathcal{C}}(\hat{f}) \circ tft_{\mathcal{C}}(\hat{\mathcal{S}}) |_{B\ell(X)}, \tag{3.36}$$

i.e., the restriction of the linear map $tft_{\mathcal{C}}(\hat{f}) \circ tft_{\mathcal{C}}(\hat{\mathcal{S}})$ to the subspace $B\ell(X)$ of $tft_{\mathcal{C}}(\widehat{X})$. As it stands, $B\ell(\varpi)$ is a linear map from $B\ell(X)$ to $tft_{\mathcal{C}}(\widehat{Y})$. We must now verify that the image of $B\ell(\varpi)$ is indeed contained in $B\ell(Y)$. This follows from

$$P_Y \circ B\ell(\varpi) \circ P_X = B\ell(\varpi) \circ P_X, \tag{3.37}$$

which can again be checked by substituting the definitions. Note that, on the other hand, $P_Y \circ B\ell(\varpi) \circ P_X$ is in general not equal to $P_Y \circ B\ell(\varpi)$.

The discussion above is summarized in the

Definition 3.7. The *block functor*

$$Bl \equiv Bl(\mathcal{C}, H_{\text{op}}, H_{\text{cl}}, B_l, B_r, e, r) : \mathcal{WSh} \rightarrow \mathcal{Vect} \tag{3.38}$$

is the assignment (3.34) on objects and (3.36) on morphisms of \mathcal{WSh} .

That Bl is indeed a functor is established in

Proposition 3.8. *The mapping $Bl: \mathcal{WSh} \rightarrow \mathcal{Vect}$ is a symmetric monoidal functor.*

Proof. We must show that $Bl(\text{id}_X) = \text{id}_{Bl(X)}$ and $Bl(\varpi \circ \varpi') = Bl(\varpi) \circ Bl(\varpi')$ (functoriality), that $Bl(\emptyset) = \mathbb{C}$, $Bl(X \sqcup Y) = Bl(X) \otimes Bl(Y)$ and $Bl(\varpi \sqcup \varpi') = Bl(\varpi) \otimes Bl(\varpi')$ (monoidal) and finally that $Bl(c_{X,Y}) = c_{Bl(X), Bl(Y)}$ (symmetric). Here, $c_{U,V} \in \text{Hom}(U \otimes V, V \otimes U)$ is the isomorphism in \mathcal{Vect} that exchanges the two factors in a tensor product.

Functoriality and symmetry follow immediately from the definition (3.36) and functoriality of $tft_{\mathcal{C}}$. The same holds for the monoidal property on morphisms. To verify that Bl is monoidal also on objects one uses in addition that the projector (3.33), in terms of which Bl is defined, satisfies $P_{X \sqcup Y} = P_X \otimes P_Y$. This latter property is not difficult to see upon substituting the explicit definition (3.31) of F_X in terms of cobordisms. \square

Remark 3.9. The definition of Bl is closely related to that of a 2D modular functor, see [34] as well as [35], [4, Chapter 5], [15, Chapter V] or [36]. The main difference is that Bl starts from a different category, namely one in which the 2D surfaces are in addition equipped with an involution, and in which the boundaries of the surface are not labelled by objects of some decoration category.

Next we show that any two functors Bl that are constructed in the manner described above from isomorphic objects H_{op} and H_{cl} are equivalent as symmetric monoidal functors. We abbreviate $Bl = Bl(\mathcal{C}, H_{\text{op}}, H_{\text{cl}}, B_l, B_r, e, r)$ and $Bl' = Bl(\mathcal{C}, H'_{\text{op}}, H'_{\text{cl}}, B'_l, B'_r, e', r')$. Let further $\varphi_{\text{op}} \in \text{Hom}_{\mathcal{C}}(H'_{\text{op}}, H_{\text{op}})$ and $\varphi_{\text{cl}} \in \text{Hom}_{\mathcal{C} \boxtimes \bar{\mathcal{C}}}(H'_{\text{cl}}, H_{\text{cl}})$ be isomorphisms. Define linear maps

$$\beta_X(\varphi_{\text{op}}, \varphi_{\text{cl}}) : tft_{\mathcal{C}}(\widehat{X}(H_{\text{op}}, B_l, B_r)) \rightarrow tft_{\mathcal{C}}(\widehat{X}(H'_{\text{op}}, B'_l, B'_r)) \tag{3.39}$$

by setting

$$\beta_X(\varphi_{\text{op}}, \varphi_{\text{cl}}) := F_X(\varphi_{\text{op}}, \varphi_{\text{op}}^{-1}, e \circ \varphi_{\text{cl}} \circ r', e' \circ \varphi_{\text{cl}}^{-1} \circ r). \tag{3.40}$$

We now show that β_X restricts to an isomorphism from $Bl(X)$ to $Bl(X')$. Note that, with the abbreviations $P_X = P_X(H_{\text{op}}, H_{\text{cl}}, B_l, B_r, e, r)$ and

$P'_X = P_X(H'_{\text{op}}, H'_{\text{cl}}, B'_l, B'_r, e', r')$, we have

$$\begin{aligned}
 P'_X \circ \beta_X &= F_X(\text{id}_{H'_{\text{op}}}, \text{id}_{H'_{\text{cl}}}, e' \circ r', e' \circ r') F_X(\varphi_{\text{op}}, \varphi_{\text{op}}^{-1}, e \circ \varphi_{\text{cl}} \circ r', e' \circ \varphi_{\text{cl}}^{-1} \circ r) \\
 &= F_X(\varphi_{\text{op}}, \varphi_{\text{op}}^{-1}, e \circ \varphi_{\text{cl}} \circ r', e' \circ \varphi_{\text{cl}}^{-1} \circ r) \\
 &= F_X(\varphi_{\text{op}}, \varphi_{\text{op}}^{-1}, e \circ \varphi_{\text{cl}} \circ r', e' \circ \varphi_{\text{cl}}^{-1} \circ r) F_X(\text{id}_{H_{\text{op}}}, \text{id}_{H_{\text{cl}}}, e \circ r, e \circ r) \\
 &= \beta_X \circ P_X, \tag{3.41}
 \end{aligned}$$

so that β_X maps $B\ell(X)$ to $B\ell'(X)$. We can thus define a linear map $\aleph_X: B\ell(X) \rightarrow B\ell'(X)$ by restricting β_X ,

$$\aleph_X(\varphi_{\text{op}}, \varphi_{\text{cl}}) := F_X(\varphi_{\text{op}}, \varphi_{\text{op}}^{-1}, e \circ \varphi_{\text{cl}} \circ r', e' \circ \varphi_{\text{cl}}^{-1} \circ r) \Big|_{B\ell(X)}. \tag{3.42}$$

Proposition 3.10. *Let $B\ell = B\ell(\mathcal{C}, H_{\text{op}}, H_{\text{cl}}, B_l, B_r, e, r)$ and $B\ell' = B\ell(\mathcal{C}, H'_{\text{op}}, H'_{\text{cl}}, B'_l, B'_r, e', r')$. For any two isomorphisms $\varphi_{\text{op}} \in \text{Hom}_{\mathcal{C}}(H'_{\text{op}}, H_{\text{op}})$ and $\varphi_{\text{cl}} \in \text{Hom}_{\mathcal{C} \boxtimes \bar{\mathcal{C}}}(H'_{\text{cl}}, H_{\text{cl}})$, the family $\{\aleph_X(\varphi_{\text{op}}, \varphi_{\text{cl}})\}$ of linear maps (3.42) is a monoidal natural isomorphism from $B\ell$ to $B\ell'$.*

Remark 3.11. In order to keep the notation simple we consider in Proposition 3.10 only the case when $B\ell$ and $B\ell'$ involve the same modular tensor category \mathcal{C} . One can also define a monoidal natural isomorphism from $B\ell$ to $B\ell'$ if in $B\ell'$ one allows a modular tensor category \mathcal{C}' equivalent (as a braided monoidal category) to \mathcal{C} and inserts the equivalence functor at the appropriate places.

The proof of Proposition 3.10 is based on two lemmas. For world sheets X and Y , consider first a homeomorphism $f: \tilde{X} \rightarrow \tilde{Y}$ of world sheets. By gluing disks with appropriately labelled arcs, from f and the data in Proposition 3.10 we obtain two morphisms of extended surfaces,

$$\begin{aligned}
 \hat{f} &: \hat{X}(H_{\text{op}}, B_l, B_r) \longrightarrow \hat{Y}(H_{\text{op}}, B_l, B_r) \quad \text{and} \\
 \hat{f}' &: \hat{X}(H'_{\text{op}}, B'_l, B'_r) \longrightarrow \hat{Y}(H'_{\text{op}}, B'_l, B'_r). \tag{3.43}
 \end{aligned}$$

Lemma 3.12. *We have*

$$\begin{aligned}
 F_Y(\varphi_{\text{op}}, \varphi_{\text{op}}^{-1}, e \circ \varphi_{\text{cl}} \circ r', e' \circ \varphi_{\text{cl}}^{-1} \circ r) \circ \text{tft}_{\mathcal{C}}(\hat{f}) \\
 = \text{tft}_{\mathcal{C}}(\hat{f}') \circ F_X(\varphi_{\text{op}}, \varphi_{\text{op}}^{-1}, e \circ \varphi_{\text{cl}} \circ r', e' \circ \varphi_{\text{cl}}^{-1} \circ r). \tag{3.44}
 \end{aligned}$$

Proof. The statement follows because the two cobordisms $N_Y(\alpha, \beta) \circ \hat{f}$ and $\hat{f}' \circ N_X(\alpha, \beta)$, with N as in (3.29), are in the same equivalence class of cobordisms. \square

On the other hand, given a sewing \mathcal{S} of a world sheet X , we have

Lemma 3.13. *With the arguments of F_X and $F_{\mathcal{S}(X)}$ the same as in Lemma 3.12, we have*

$$F_{\mathcal{S}(X)} \circ tft_C(\hat{\mathcal{S}}) \circ P_X = tft_C(\hat{\mathcal{S}}) \circ F_X. \tag{3.45}$$

Proof. The claim follows by substituting the various definitions in terms of cobordisms. The additional idempotent accounts for the projector resulting from composing $e \circ \varphi_{cl} \circ r'$ and $e' \circ \varphi_{cl}^{-1} \circ r$ at sewings of closed state boundaries in $tft_C(\hat{\mathcal{S}}) \circ F_X$. For example, consider the world sheet X in (3.9) and a sewing \mathcal{S} which consists of sewing the two open state boundaries and the two closed state boundaries (the set \mathcal{S} thus consists of three pairs). Then $\mathcal{S}(X)$ has no state boundaries (i.e., $\widetilde{\mathcal{S}(X)}$ has empty boundary). Expand the morphism $p := e \circ r$ as $p = \sum_{\alpha} p_{l,\alpha} \otimes p_{r,\alpha}$. Substituting the definitions, we find that the left-hand side of (3.45) is given by

$$F_{\mathcal{S}(X)} \circ tft_C(\hat{\mathcal{S}}) \circ P_X = \sum_{\alpha,\beta} \text{Diagram} \tag{3.46}$$

In this figure, the disk A has to be identified with the disk A' , as well as B with B' and C with C' . The application of tft_C to the cobordism is understood. Note that since $\widetilde{\mathcal{S}(X)}$ has empty boundary, $F_{\mathcal{S}(X)}$ is just the identity on $B\ell(\mathcal{S}(X))$. For the right-hand side of (3.45), write $c = e \circ \varphi_{cl} \circ r'$, $d = e' \circ \varphi_{cl}^{-1} \circ r$ and expand $c = \sum_{\alpha} c_{l,\alpha} \otimes c_{r,\alpha}$, $d = \sum_{\alpha} d_{l,\alpha} \otimes d_{r,\alpha}$. Inserting the definitions, one finds

$$tft_C(\hat{\mathcal{S}}) \circ F_X = \sum_{\alpha,\beta} \text{Diagram} \tag{3.47}$$

Here the identifications are as in (3.46). Taking the morphisms $d_{l/r}$ and φ_{op}^{-1} through the identifications, one obtains

$$\begin{aligned} & \text{tft}_{\mathcal{C}}(\hat{\mathcal{S}}) \circ F_X(\varphi_{\text{op}}, \varphi_{\text{op}}^{-1}, c, d) \\ &= \text{tft}_{\mathcal{C}}(\hat{\mathcal{S}}) \circ F_X(\varphi_{\text{op}}^{-1}, \text{id}_{H_{\text{op}}}, d, \text{id}_{B_l \times \overline{B_r}}) \circ F_X(\varphi_{\text{op}}, \text{id}_{H_{\text{op}}}, c, \text{id}_{B_l \times \overline{B_r}}) \\ &= \text{tft}_{\mathcal{C}}(\hat{\mathcal{S}}) \circ F_X(\varphi_{\text{op}} \circ \varphi_{\text{op}}^{-1}, \text{id}_{H_{\text{op}}}, c \circ d, \text{id}_{B_l \times \overline{B_r}}), \end{aligned} \tag{3.48}$$

where the last step uses (3.32). Now $c \circ d = e \circ \varphi_{\text{cl}} \circ r' \circ e' \circ \varphi_{\text{cl}}^{-1} \circ r = e \circ r = p$. Replacing p by $p \circ p$ and redoing the above steps in opposite order (without inserting φ_{op}), one indeed arrives at (3.46). \square

Proof of Proposition 3.10. To see that each of the linear maps $\aleph_X(\varphi_{\text{op}}, \varphi_{\text{cl}})$ is an isomorphism, one verifies that it has $\aleph_X(\varphi_{\text{op}}^{-1}, \varphi_{\text{cl}}^{-1})$ as a two-sided inverse. That $\aleph_X(\varphi_{\text{op}}^{-1}, \varphi_{\text{cl}}^{-1})$ is a left-inverse follows directly by using the rule (3.32):

$$\begin{aligned} & \aleph_X(\varphi_{\text{op}}^{-1}, \varphi_{\text{cl}}^{-1}) \aleph_X(\varphi_{\text{op}}, \varphi_{\text{cl}}) \\ &= F_X(\varphi_{\text{op}}^{-1}, \varphi_{\text{op}}, e' \circ \varphi_{\text{cl}}^{-1} \circ r, e \circ \varphi_{\text{cl}} \circ r') F_X(\varphi_{\text{op}}, \varphi_{\text{op}}^{-1}, e \circ \varphi_{\text{cl}} \circ r', e' \circ \varphi_{\text{cl}}^{-1} \circ r) \\ &= F_X(\text{id}_{H_{\text{op}}}, \text{id}_{H_{\text{op}}}, e \circ r, e \circ r) = P_X = \text{id}_{Bl(X)}. \end{aligned} \tag{3.49}$$

The right-inverse property follows similarly.

To see that $\aleph \equiv \aleph(\varphi_{\text{op}}, \varphi_{\text{cl}})$ defines a natural transformation, we must check that for each morphism $\varpi: X \rightarrow Y$ between two world sheets, the square

$$\begin{array}{ccc} Bl(X) & \xrightarrow{Bl(\varpi)} & Bl(Y) \\ \downarrow \aleph_X & & \downarrow \aleph_Y \\ Bl'(X) & \xrightarrow{Bl'(\varpi)} & Bl'(Y) \end{array} \tag{3.50}$$

commutes. This follows from substituting definitions (3.36) of $Bl(\varpi)$ and (3.42) of \aleph , and applying Lemmas 3.12 and 3.13. Finally, the property that the natural transformation \aleph is monoidal amounts to the statement that

$$\begin{array}{ccc} Bl(X \sqcup Y) & \xrightarrow{\cong} & Bl(X) \otimes Bl(Y) \\ \downarrow \aleph_{X \sqcup Y} & & \downarrow \aleph_X \otimes \aleph_Y \\ Bl'(X \sqcup Y) & \xrightarrow{\cong} & Bl'(X) \otimes Bl'(Y) \end{array} \tag{3.51}$$

commutes. That this is indeed satisfied is a direct consequence of the fact that $\text{tft}_{\mathcal{C}}$ is a monoidal functor, and the isomorphisms in (3.51) follow from isomorphisms $\text{tft}_{\mathcal{C}}(M \sqcup N) \xrightarrow{\cong} \text{tft}_{\mathcal{C}}(M) \otimes \text{tft}_{\mathcal{C}}(N)$ which form part of the data specifying a monoidal functor. \square

3.4 Correlators and sewing constraints

With the help of the concepts introduced in Sections 3.1 and 3.3, we can finally formulate the central notion of our investigation, namely what we call a “solution to the sewing constraints,” or synonymously, a “consistent collection of correlators.”

Definition 3.14. For given data $\mathcal{C}, H_{\text{op}}, H_{\text{cl}}, B_l, B_r, e, r$, a *solution to the sewing constraints*, or *consistent collection of correlators* is given by a monoidal natural transformation Cor from One to the block functor $B\ell \equiv B\ell(\mathcal{C}, H_{\text{op}}, H_{\text{cl}}, B_l, B_r, e, r)$.

We also refer to the tuple

$$S = (\mathcal{C}, H_{\text{op}}, H_{\text{cl}}, B_l, B_r, e, r, Cor) \quad (3.52)$$

as a solution to the sewing constraints and call Cor the *collection of correlators*.

Given a solution S we will denote the data e and r also by e_S and r_S , and write

$$p_S := e_S \circ r_S; \quad (3.53)$$

p_S is an idempotent.

Let us disentangle the meaning of this definition.

- First of all, as a natural transformation, Cor assigns to every world sheet X a linear map $Cor_X: One(X) \rightarrow B\ell(X)$; we call $Cor_X: \mathbb{C} \rightarrow B\ell(X)$ the *correlator of the world sheet X* .
- Next, by definition of a natural transformation, the diagram

$$\begin{array}{ccc} \mathbb{C} = One(X) & \xrightarrow{One(\varpi)} & One(Y) = \mathbb{C} \\ \downarrow Cor_X & & \downarrow Cor_Y \\ B\ell(X) & \xrightarrow{B\ell(\varpi)} & B\ell(Y) \end{array} \quad (3.54)$$

commutes for every morphism $\varpi: X \rightarrow Y$ of world sheets. Since $One(\varpi) = \text{id}_{\mathbb{C}}$, commutativity of the diagram means that

$$Cor_Y = B\ell(\varpi) \circ Cor_X. \quad (3.55)$$

- The relation (3.55) expresses the *covariance of the correlators* under arbitrary morphisms of \mathcal{WSh} , i.e., both homeomorphisms and sewings. It includes in particular the usual covariance property, namely when $\varpi = (\emptyset, f)$ for two world sheets X and Y and a homeomorphism

$f: \tilde{X} \rightarrow \tilde{Y}$, i.e., the case that there is no sewing. In this case transporting $Cor_X: \mathbb{C} \rightarrow Bl(X)$ from $Bl(X)$ to $Bl(Y)$ using the linear map $Bl((\emptyset, f))$ results in Cor_Y .

- Similarly, given a world sheet X and sewing data \mathcal{S} for X , we can apply (3.55) to the morphism $\varpi = (\mathcal{S}, \text{id}_{\widetilde{\mathcal{S}(X)}}): X \rightarrow \mathcal{S}(X)$. It states that the correlator on X and on the sewn world sheet $\mathcal{S}(X)$ are related by the linear map

$$Bl((\mathcal{S}, \text{id}_{\widetilde{\mathcal{S}(X)}})): Bl(X) \rightarrow Bl(\mathcal{S}(X)) \tag{3.56}$$

between the spaces of blocks for the world sheet and the sewn word sheet. This expresses *consistency of the correlators with sewing* and thereby justifies our terminology.

- Finally, that Cor is monoidal implies that⁶

$$Cor_{X \sqcup Y} = Cor_X \otimes Cor_Y, \tag{3.57}$$

i.e., the correlator evaluated on a disconnected world sheet $X \sqcup Y$ is just the tensor product of the correlators evaluated on the individual world sheets X and Y .

3.5 Equivalence of solutions to the sewing constraints

It is not difficult to convince oneself that different tuples S and S' may describe CFTs that one wants to consider as “equal” on physical grounds. In other words, we need to introduce a suitable equivalence relation. The notion of equivalence must be broad enough to accommodate the following.

First, a solution to the sewing constraints can be obtained from a symmetric special Frobenius algebra; we recall this construction in Section 4.3. Furthermore, as shown in [1, 12], correlators obtained from Morita equivalent algebras differ only by constants related to the Euler character of the world sheet (provided the boundary conditions are related as described in [1, 12]).

Next, B_l and B_r are only auxiliary data. Accordingly, two solutions S and S' which only differ in the way H_{cl} is realized as a retract (of $B_l \times \overline{B}_r$ or of $B'_l \times \overline{B}'_r$, respectively) should be equivalent. In other words, if two functors $B\ell$ and $B\ell'$ are related by $B\ell' = \aleph(\varphi_{op}, \varphi_{cl}) \circ B\ell$ (see Proposition 3.10), then the two solutions $Cor: One \rightarrow B\ell$ and $Cor': One \rightarrow B\ell'$ should be equivalent.

⁶In writing this equality it is understood that one has to apply the natural isomorphism $tft_C(- \sqcup -) \xrightarrow{\cong} tft_C(-) \otimes tft_C(-)$ to the left-hand side. Here and below we do not spell out this isomorphism explicitly.

Moreover, working with fields rather than states, as is possible owing to the field-state correspondence in CFT (and is natural from the point of view of statistical mechanics), one should regard two CFTs as equivalent if upon a suitable isomorphism between the spaces of fields all expectation values (correlators normalized such that the identity field has expectation value one) agree. This leaves the freedom to modify the correlators by a multiplicative constant, as such a constant cancels when passing to expectation values. Thus two solutions S and S' are to be regarded as equivalent if they only differ in the assignment of correlators in such a way that $Cor'(X) = f(X) Cor(X)$ for some function f that assigns a nonzero constant to every world sheet X . Consistency with sewing then requires $f(X)$ to be of the form

$$f(X) = \gamma^{2\chi(X)} \quad (3.58)$$

for some $\gamma \in \mathbb{C}^\times$, with $\chi(X)$ the Euler character of X , which by

$$\chi(X) := \frac{1}{2} \chi(\tilde{X}) \quad (3.59)$$

is defined through the one of \tilde{X} . For connected \tilde{X} , the latter is given by $\chi(\tilde{X}) = 2 - 2g(\tilde{X}) - b(\tilde{X})$, with $g(\tilde{X})$ the genus of \tilde{X} (or rather, of the surface with empty boundary obtained by closing all holes of \tilde{X} with disks), and b the number of boundary components of \tilde{X} . In terms of the quotient surface \dot{X} , we can write

$$\chi(X) = 2 - 2g(\dot{X}) - b(\dot{X}) - \frac{1}{2}|o| - |c|, \quad (3.60)$$

where $g(\dot{X})$ is the genus of \dot{X} , $b(\dot{X})$ the number of connected components of $\partial\dot{X}$, $|c|$ the number of closed state boundaries of X and $|o|$ the number of open state boundaries of X . For example, for X a disk with m open state boundaries one has $\chi(X) = 1 - \frac{1}{2}m$.

The following observations are relevant when formalizing the notion of equivalence.

Lemma 3.15. *For any $\gamma \in \mathbb{C}^\times$, the assignment $X \mapsto G_X^\gamma := \gamma^{\chi(\tilde{X})} \text{id}_{Bl(X)}$ defines a monoidal natural self-equivalence G^γ of $Bl(\mathcal{C}, H_{\text{op}}, H_{\text{cl}}, B_l, B_r, e, r)$.*

Proof. That G^γ is a natural transformation amounts to verifying that for every morphism $\varpi: X \rightarrow Y$ we have $Bl(\varpi) \circ G_X^\gamma = G_Y^\gamma \circ Bl(\varpi)$. One checks that both for $\varpi = (\emptyset, f)$ and for $\varpi = (S, \text{id}_{\widetilde{S(X)}})$ one has $\chi(\tilde{X}) = \chi(\tilde{Y})$, and thus this remains true in the general case which is a composition of the two. The monoidal structure is just the additivity of the Euler character with respect to disjoint union. \square

Now let S and S' be two solutions to the sewing constraints. As in Proposition 3.10 we only consider the situation that S and S' involve the same modular tensor category \mathcal{C} . (This is again just for simplicity of presentation, compare Remark 3.11.) Thus $S = (\mathcal{C}, H_{\text{op}}, H_{\text{cl}}, B_l, B_r, e, r, \text{Cor})$ and $S' = (\mathcal{C}, H'_{\text{op}}, H'_{\text{cl}}, B'_l, B'_r, e', r', \text{Cor}')$.

Lemma 3.16. *Given two solutions S and S' as above, and given two isomorphisms $\varphi_{\text{op}} \in \text{Hom}(H'_{\text{op}}, H_{\text{op}})$ and $\varphi_{\text{cl}} \in \text{Hom}(H'_{\text{cl}}, H_{\text{cl}})$, abbreviate $\aleph \equiv \aleph(\varphi_{\text{op}}, \varphi_{\text{cl}})$. Suppose that $\text{Cor}'_{Y_\mu} = \gamma^{2\chi(Y_\mu)} \aleph_{Y_\mu} \circ \text{Cor}_{Y_\mu}$ for some $\gamma \in \mathbb{C}^\times$ and for world sheets Y_μ , $\mu \in \{1, 2, \dots, n\}$. Let X be a world sheet for which there exists a morphism $\varpi: Y_{\mu_1} \sqcup \dots \sqcup Y_{\mu_n} \rightarrow X$. Then also $\text{Cor}'_X = \gamma^{2\chi(X)} \aleph_X \circ \text{Cor}_X$.*

Proof. Abbreviating also $B\ell \equiv B\ell(\mathcal{C}, H_{\text{op}}, H_{\text{cl}}, B_l, B_r, e, r)$ and $B\ell' \equiv B\ell(\mathcal{C}, H'_{\text{op}}, H'_{\text{cl}}, B'_l, B'_r, e', r')$, we have

$$\begin{aligned}
 \text{Cor}'_X &\stackrel{(1)}{=} B\ell'(\varpi) \circ \text{Cor}'_{Y_{\mu_1} \sqcup \dots \sqcup Y_{\mu_n}} \\
 &\stackrel{(2)}{=} B\ell'(\varpi) \circ (\text{Cor}'_{Y_{\mu_1}} \otimes \dots \otimes \text{Cor}'_{Y_{\mu_n}}) \\
 &\stackrel{(3)}{=} \gamma^{2\chi(Y_{\mu_1}) + \dots + 2\chi(Y_{\mu_n})} B\ell'(\varpi) \circ (\aleph_{Y_{\mu_1}} \otimes \dots \otimes \aleph_{Y_{\mu_n}}) \\
 &\quad \circ (\text{Cor}_{Y_{\mu_1}} \otimes \dots \otimes \text{Cor}_{Y_{\mu_n}}) \\
 &\stackrel{(4)}{=} \gamma^{2\chi(X)} B\ell'(\varpi) \circ \aleph_{Y_{\mu_1} \sqcup \dots \sqcup Y_{\mu_n}} \circ \text{Cor}_{Y_{\mu_1} \sqcup \dots \sqcup Y_{\mu_n}} \\
 &\stackrel{(5)}{=} \gamma^{2\chi(X)} \aleph_X \circ B\ell(\varpi) \circ \text{Cor}_{Y_{\mu_1} \sqcup \dots \sqcup Y_{\mu_n}} \\
 &\stackrel{(6)}{=} \gamma^{2\chi(X)} \aleph_X \circ \text{Cor}_X.
 \end{aligned} \tag{3.61}$$

Steps (1) and (6) are examples of the identity (3.55), i.e., naturality of Cor and Cor' ; step (2) holds because Cor' is monoidal, step (3) holds by the assumption of the lemma, step (4) combines monoidality of \aleph and Cor with additivity of the Euler character and finally step (5) is naturality of \aleph . \square

Combining all these considerations we are led to the following notion of equivalence.

Definition 3.17. Two solutions $S = (\mathcal{C}, H_{\text{op}}, H_{\text{cl}}, B_l, B_r, e, r, \text{Cor})$ and $S' = (\mathcal{C}, H'_{\text{op}}, H'_{\text{cl}}, B'_l, B'_r, e', r', \text{Cor}')$ to the sewing constraints that are based on the same category \mathcal{C} are called *equivalent* iff there exists a $\gamma \in \mathbb{C}^\times$ and isomorphisms $\varphi_{\text{op}} \in \text{Hom}(H'_{\text{op}}, H_{\text{op}})$ and $\varphi_{\text{cl}} \in \text{Hom}(H'_{\text{cl}}, H_{\text{cl}})$ such that the identity

$$\text{Cor}' = G^\gamma \circ \aleph(\varphi_{\text{op}}, \varphi_{\text{cl}}) \circ \text{Cor}. \tag{3.62}$$

between natural transformation holds.

4 Frobenius algebras and solutions to the sewing constraints

Solutions to the sewing constraints are intimately related with Frobenius algebras in the category \mathcal{C} that enters the formulation of the sewing constraints. From any symmetric special Frobenius algebra in \mathcal{C} one can construct a solution to the sewing constraints; this result of [1, 2] will be recalled in Section 4.3. In Section 4.4 we will show that, conversely, any solution \mathbf{S} gives rise to a symmetric Frobenius algebra in \mathcal{C} . Under suitable assumptions on \mathbf{S} , this algebra is also special. We can then state, in Section 4.5, our main result, namely that the procedures of constructing correlators from a symmetric special Frobenius algebra and of determining an algebra from a solution to the sewing constraints are inverse to each other. In the next two sections we start by collecting some notations and tools that we will need, in particular the fundamental world sheets from which all world sheets can be obtained via sewing (Section 4.1) and the notion of projecting onto the closed state vacuum (Section 4.2).

4.1 Fundamental correlators

Every world sheet X can be obtained by applying sewing to a small collection of fundamental world sheets [24, 37–39]. In terms of the category \mathcal{WSh} this means that for every world sheet X there is a (nonunique) morphism

$$\varpi : \bigsqcup_{\alpha \in C_X} Y_\alpha \longrightarrow X, \quad (4.1)$$

where C_X is a finite-index set and each of the world sheets Y_α is one of the world sheets that are displayed in figure 2. We will refer to them as *fundamental* world sheets; the symbols $m, \eta, \Delta, \varepsilon$ refer to the morphisms in formula (4.35) below, while “ B ” stands for bulk. Of course, one may also use other sets of fundamental world sheets. For instance, one could replace $X_{B\varepsilon}$ in figure 2 by $X_{B\eta}$ in figure 3.

We also display, in figure 3, five other simple world sheets, namely $X_{B\eta}$, the projectors X_p and X_{Bp} which will be used below, e.g., to formulate the conditions in the uniqueness theorem, Theorem 4.26, and the “pairs of pants” X_{Bm} and $X_{B\Delta}$ which have been used as fundamental world sheets elsewhere in the literature. These are only shown to point out clearly that also these particular world sheets can be obtained by gluing world sheets from figure 2. For convenience, all these world sheets are also collected in table 2.

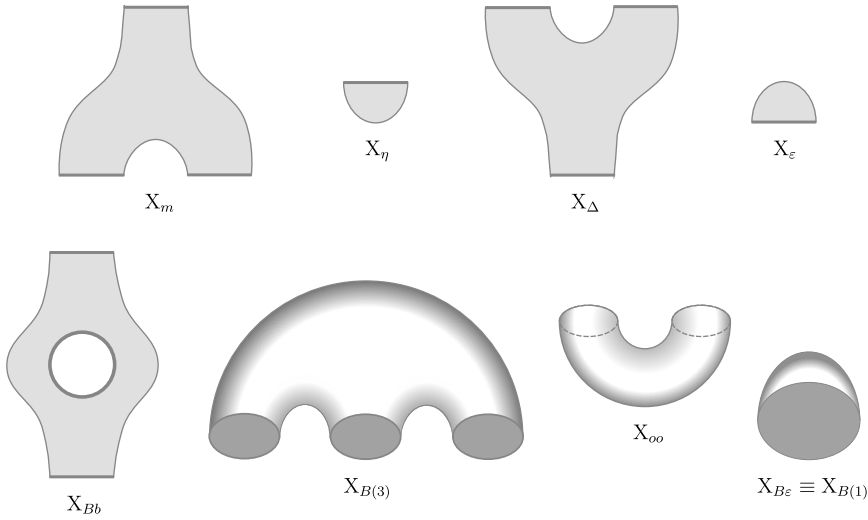

Figure 2: List of fundamental world sheets. Any world sheet X can be decomposed into surfaces in this list by repeatedly cutting along intervals or circles. In each of these world sheet pictures the bottom boundaries are in-going and the top boundaries out-going, while the closed state boundary drawn in the middle of X_{Bb} is in-going.

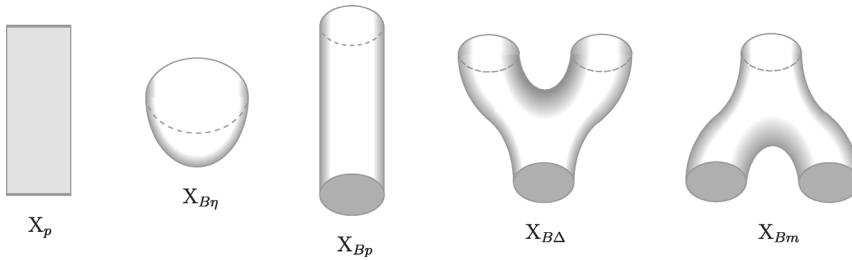

Figure 3: Some other simple world sheets, included for convenience.

By invoking Lemma 3.16 in the special case $Cor' = Cor$ (and hence $\gamma = 1$), it follows that a collection Cor of correlators is uniquely determined on all of \mathcal{WSh} already by the finite subset $\{Cor(X)\}$ for the fundamental world sheets X .

The correlators assigned to fundamental world sheets can be related to specific morphisms of \mathcal{C} with the help of the suitable cobordisms; these cobordisms are listed in figure 4. Consider for example the world sheet X_m . The decorated double of X_m is a sphere with two arcs marked by $(H_{op}, +)$ and one arc marked by $(H_{op}, -)$. According to (3.15), the space $B\ell(X_m) = tft_{\mathcal{C}}(\widehat{X}_m)$

Table 2: Fundamental and other simple world sheets, as listed in figures 2 and 3, respectively.

X_m	A disk with two in-going and one out-going open state boundaries
X_η	A disk with one out-going open state boundary
X_Δ	A disk with one in-going and two out-going open state boundaries
X_ε	A disk with one in-going open state boundary
X_{Bb}	A disk with one in- and one out-going open state boundary and one in-going closed state boundary
$X_{B(3)}$	A sphere with three in-going closed state boundaries
$X_{B(1)} \equiv X_{B\varepsilon}$	A sphere with one in-going closed state boundary
X_{oo}	A sphere with two out-going closed state boundaries

X_p	A disk with one in- and one out-going open state boundary
$X_{B\eta}$	A sphere with one out-going closed state boundary
X_{Bp}	A sphere with one in- and one out-going closed state boundary
$X_{B\Delta}$	A sphere with one in- and two out-going closed state boundaries
X_{Bm}	A sphere with two in- and one out-going closed state boundaries

is isomorphic to $\text{Hom}(H_{\text{op}} \otimes H_{\text{op}} \otimes H_{\text{op}}^\vee, \mathbf{1}) \cong \text{Hom}(H_{\text{op}} \otimes H_{\text{op}}, H_{\text{op}})$. An isomorphism is provided by considering the cobordism $F(X_m; f) \equiv F(X_m; \mathcal{C}, H_{\text{op}}; f): \emptyset \rightarrow \widehat{X}_m$ shown as the first picture of figure 4, where f is an element of $\text{Hom}(H_{\text{op}} \otimes H_{\text{op}}, H_{\text{op}})$:⁷

$$\Psi_m : \text{Hom}(H_{\text{op}} \otimes H_{\text{op}}, H_{\text{op}}) \rightarrow \text{tft}_{\mathcal{C}}(\widehat{X}_m), \quad f \xrightarrow{\Psi_m} \text{tft}_{\mathcal{C}}(F(X_m; f)). \quad (4.2)$$

Analogously, given the cobordisms in figure 4, we define

- for $X \in \{X_\eta, X_\Delta, X_\varepsilon, X_p\}$ cobordisms $F(X; f) \equiv F(X; \mathcal{C}, H_{\text{op}}; f): \emptyset \rightarrow \widehat{X}$;
- for X_{Bb} a cobordism $F(X_{Bb}; f) \equiv F(X_{Bb}; \mathcal{C}, H_{\text{op}}, B_l, B_r; f): \emptyset \rightarrow \widehat{X}_{Bb}$;

⁷Strictly speaking, $\text{tft}_{\mathcal{C}}(F(X_m; f))$ is a linear map $\mathbb{C} \rightarrow \text{tft}_{\mathcal{C}}(\widehat{X}_m)$. One obtains an element of $\text{tft}_{\mathcal{C}}(\widehat{X}_m)$ by evaluating this linear map on $1 \in \mathbb{C}$. It is understood that this is done implicitly where necessary.

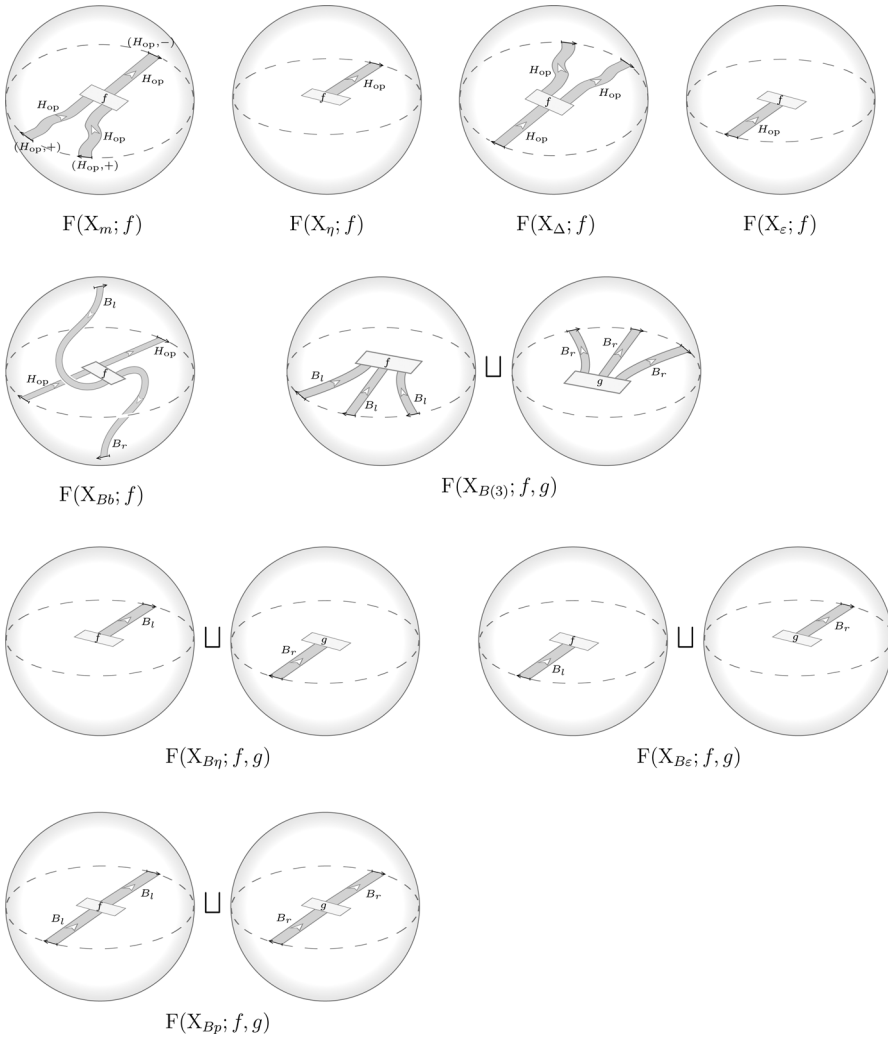

Figure 4: Cobordisms $F(X; f): \emptyset \rightarrow \widehat{X}$ for each of the fundamental world sheets in figure 2 and for X_{Bp} from figure 3.

- for $X \in \{X_{B(1)}, X_{oo}, X_{B(3)}, X_{B\eta}, X_{Bp}\}$ cobordisms $F(X; f, g) \equiv F(X; \mathcal{C}, B_l, B_r; f, g): \emptyset \rightarrow \widehat{X}$.

As in (4.2), applying the 3D TFT to these cobordisms yields linear isomorphisms between certain morphism spaces of \mathcal{C} and $tft_{\mathcal{C}}(\widehat{X})$. For example,

$$tft_{\mathcal{C}}(F(X_{Bb}; \cdot)).1 : \text{Hom}(H_{op} \otimes B_l, H_{op} \otimes B_r) \xrightarrow{\cong} tft_{\mathcal{C}}(\widehat{X}_{Bb}). \quad (4.3)$$

However, when closed state boundaries are present on X , according to the projection in prescription (3.34) we do in general no longer have $B\ell(X) = \text{tft}_{\mathcal{C}}(\widehat{X})$, but only $B\ell(X) \subset \text{tft}_{\mathcal{C}}(\widehat{X})$.

4.2 Projecting onto the closed state vacuum

In this section we define the operation of *projecting onto the closed state vacuum*. It can be thought of as “pinching” a circle on the world sheet, i.e., replacing an annulus-shaped subset of the surface \dot{X} by two half-spheres. This procedure can be applied in all CFTs for which the closed state vacuum is unique, i.e., when

$$\dim_{\mathbb{C}} \text{Hom}_{\mathcal{C} \boxtimes \bar{\mathcal{C}}}(\mathbf{1} \times \bar{\mathbf{1}}, H_{\text{cl}}) = 1; \quad (4.4)$$

it will be crucial when proving the uniqueness theorem in Section 5 below.

Let $S = (\mathcal{C}, H_{\text{op}}, H_{\text{cl}}, B_l, B_r, e, r, \text{Cor})$ be a solution to the sewing constraints. We first analyse the correlators of the closed world sheets $X_{B\eta}$ and $X_{B\varepsilon}$ in figure 2. The correlator for the first of them is a linear map $\text{Cor}_{X_{B\eta}}: \mathbb{C} \rightarrow \text{tft}_{\mathcal{C}}(\widehat{X}_{B\eta})$, where

$$\text{tft}_{\mathcal{C}}(\widehat{X}_{B\eta}) \cong \text{Hom}(\mathbf{1}, B_l) \otimes_{\mathbb{C}} \text{Hom}(B_r, \mathbf{1}) = \text{Hom}_{\mathcal{C} \boxtimes \bar{\mathcal{C}}}(\mathbf{1} \times \bar{\mathbf{1}}, B_l \times \bar{B}_r). \quad (4.5)$$

An isomorphism between the first two spaces is obtained via the cobordism $F(X_{B\eta}; \cdot, \cdot)$ in figure 4, while the equality of the second and third expressions holds by definition of the morphism spaces of $\mathcal{C} \boxtimes \bar{\mathcal{C}}$, see Section 3.2. Thus there exists a unique $u_{B\eta} \in \text{Hom}(\mathbf{1}, B_l) \otimes_{\mathbb{C}} \text{Hom}(B_r, \mathbf{1})$ such that when written as $u_{B\eta} = \sum_{\alpha} u'_{\alpha} \otimes u''_{\alpha}$ with $u'_{\alpha} \in \text{Hom}(\mathbf{1}, B_l)$ and $u''_{\alpha} \in \text{Hom}(B_r, \mathbf{1})$ one has

$$\text{Cor}_{X_{B\eta}} = \sum_{\alpha} \text{tft}_{\mathcal{C}}(F(X_{B\eta}; u'_{\alpha}, u''_{\alpha})). \quad (4.6)$$

Similarly, via the cobordism $F(X_{B\varepsilon}; \cdot, \cdot)$ the correlator $\text{Cor}_{X_{B\varepsilon}}$ corresponds to an element $u_{B\varepsilon} \in \text{Hom}(B_l, \mathbf{1}) \otimes_{\mathbb{C}} \text{Hom}(\mathbf{1}, B_r)$.

Given any world sheet X , one can embed a parametrized little disk D into \dot{X} and write \dot{X} as the union of D and $\dot{X} \setminus D$. Similarly one can find a world sheet Y such that there exists a morphism $\varpi: Y \sqcup X_{B\eta} \rightarrow X$. Writing

$\varpi = (\mathcal{S}, f)$, this gives

$$\begin{aligned}
 \text{Cor}_X &= \text{Bl}(\varpi) \circ \text{Cor}_{Y \sqcup X_{B\eta}} \\
 &= \text{Bl}(\varpi) \circ (\text{Cor}_Y \otimes \text{Cor}_{X_{B\eta}}) \\
 &= \sum_{\alpha} \text{tft}_C(f) \circ \text{tft}_C(\hat{\mathcal{S}}) \circ (\text{Cor}_Y \otimes \text{tft}_C(F(X_{B\eta}; u'_{\alpha}, u''_{\alpha}))) \\
 &= \sum_{\alpha} \text{tft}_C(f) \circ \text{tft}_C(\hat{\mathcal{S}} \circ (\text{id}_Y \sqcup F(X_{B\eta}; u'_{\alpha}, u''_{\alpha}))) \circ \text{Cor}_Y. \tag{4.7}
 \end{aligned}$$

In a neighbourhood of $X_{B\eta}$, the cobordism appearing in the last line looks as

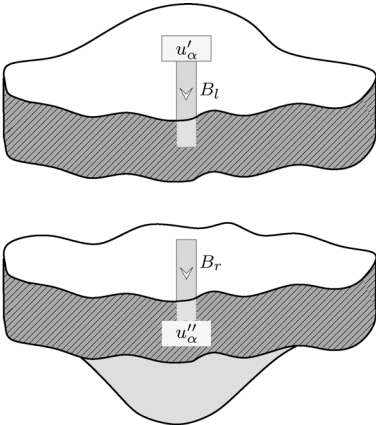

$\hat{\mathcal{S}} \circ (\text{id}_Y \sqcup F(X_{B\eta}; u'_{\alpha}, u''_{\alpha})) =$

$\tag{4.8}$

In this picture, the top and bottom surfaces are part of $\mathcal{S}(\widehat{Y \sqcup X_{B\eta}}) \cong \widehat{X}$, and the two inner boundaries (on which the B_l and B_r ribbons end/start) are part of \widehat{Y} .

The above discussion motivates us to formulate

Lemma 4.1. *If there exists at least one world sheet X with $\text{Cor}_X \neq 0$, then the morphisms $u_{B\eta}$ and $u_{B\varepsilon}$ are nonzero.*

Proof. Let X be a world sheet such that $\text{Cor}_X \neq 0$ and let Y be a world sheet for which there exists a morphism $\varpi: Y \sqcup X_{B\eta} \rightarrow X$. Then the right-hand side of (4.7) must be nonzero. For this to be the case it is necessary that $\sum_{\alpha} u'_{\alpha} \otimes u''_{\alpha} \neq 0$. That also $u_{B\varepsilon} \neq 0$ can be seen similarly. □

By a *purely closed sewing* of a world sheet X we mean sewing data \mathcal{S} for X such that for all pairs $(a, b) \in \mathcal{S}$ we have $(a, b) \neq (\iota_*(a), \iota_*(b))$. Given a purely closed sewing, we define a cobordism $M_{\mathcal{S}, X}^{\text{vac}}: \widehat{\mathcal{S}(X)} \rightarrow \widehat{\mathcal{S}(X)}$ as follows. Start from the cylinder $\widehat{\mathcal{S}(X)} \times [0, 1]$. For each pair $(a, b) \in \mathcal{S}$ define the circle $C_{(a,b)} := \pi_{\mathcal{S}, X}(C_a) = \pi_{\mathcal{S}, X}(C_b)$ embedded in $\widehat{\mathcal{S}(X)} \subset \widehat{\mathcal{S}(X)}$, where C_a and C_b are

the boundary components of $\partial\tilde{X}$ corresponding to $a, b \in \pi_0(\partial\tilde{X})$. On each annulus $C_{(a,b)} \times [0, 1] \subset M_{\mathcal{S}, X}^{\text{vac}}$ insert a coupon labelled by the morphism w_K defined in (3.18) and an annulus-shaped K -ribbon starting and ending on this coupon, in such a way that the core of the K -ribbon lies on $C_{(a,b)} \times \{\frac{1}{2}\}$. In a neighbourhood of such an annulus, $M_{\mathcal{S}, X}^{\text{vac}}$ looks as

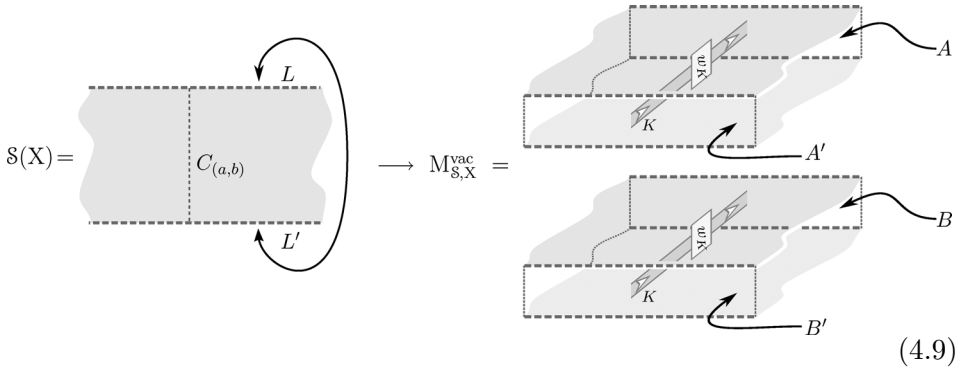

(4.9)

Here the lines L and L' are to be identified. Likewise, the faces A and A' , as well as B and B' , must be identified. Now define a linear map $P_{\mathcal{S}, X}^{\text{vac}}$ as

$$P_{\mathcal{S}, X}^{\text{vac}} := \text{tft}_C(M_{\mathcal{S}, X}^{\text{vac}}) : Bl(\mathcal{S}(X)) \rightarrow Bl(\mathcal{S}(X)). \tag{4.10}$$

It is not difficult to check that $P_{\mathcal{S}, X}^{\text{vac}}$, which is initially a linear map from $\text{tft}_C(\widehat{\mathcal{S}(X)})$ to itself, indeed restricts to an endomorphism of $Bl(\mathcal{S}(X))$. In fact, given two solutions $\mathcal{S}, \mathcal{S}'$ to the sewing constraints and denoting by $P_{\mathcal{S}, X}^{\text{vac}}$ the linear map (4.10) with ribbons labelled by the data in \mathcal{S} and by $P_{\mathcal{S}, X}'^{\text{vac}}$ the corresponding map with ribbons labelled by the data in \mathcal{S}' , it is straightforward to verify by substituting the explicit form of the cobordisms that

$$F_X(o^{\text{in}}, o^{\text{out}}, c^{\text{in}}, c^{\text{out}}) P_{\mathcal{S}, X}^{\text{vac}} = P_{\mathcal{S}, X}'^{\text{vac}} F_X(o^{\text{in}}, o^{\text{out}}, c^{\text{in}}, c^{\text{out}}), \tag{4.11}$$

where F_X is the linear map defined in (3.31). In particular, by the definition of \aleph in (3.42), for isomorphisms $\varphi_{\text{op}} \in \text{Hom}(H'_{\text{op}}, H_{\text{op}})$ and $\varphi_{\text{cl}} \in \text{Hom}(H'_{\text{cl}}, H_{\text{cl}})$ we have

$$\aleph(\varphi_{\text{op}}, \varphi_{\text{cl}})_X P_{\mathcal{S}, X}^{\text{vac}} = P_{\mathcal{S}, X}'^{\text{vac}} \aleph(\varphi_{\text{op}}, \varphi_{\text{cl}})_X. \tag{4.12}$$

Furthermore, $P_{\mathcal{S}, X}^{\text{vac}}$ has the following property.

Lemma 4.2. *Let $X = Y \sqcup X_{B\eta}$ for some world sheet Y . Let $a \in \pi_0(\partial\tilde{X}_{B\eta})$ and $b \in \pi_0(\partial\tilde{Y})$ be such that $\mathcal{S} = \{(a, b), (\iota_*(a), \iota_*(b))\}$ are sewing data for X . Then*

$$P_{\mathcal{S}, X}^{\text{vac}} \circ \text{Cor}_{\mathcal{S}(X)} = \text{Cor}_{\mathcal{S}(X)}. \tag{4.13}$$

Proof. In a neighbourhood of the disk $X_{B\eta}$ the cobordism $M_{\mathcal{S},X}^{\text{vac}}$ constructed above takes the following simple form:

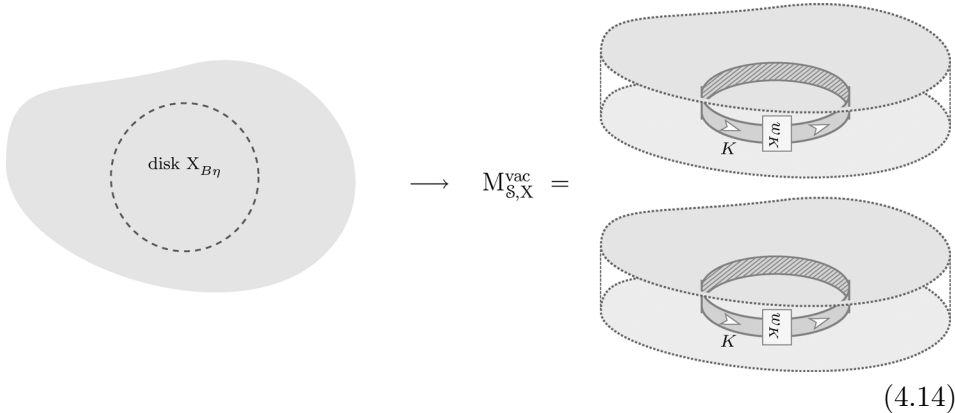

$$(4.14)$$

By (3.19), the two annulus-shaped K -ribbons can be omitted without changing $tft_C(M_{\mathcal{S},X}^{\text{vac}})$. The resulting cobordism is just the cylinder over $\widehat{\mathcal{S}(X)}$, and hence $P_{\mathcal{S},X}^{\text{vac}} = tft_C(M_{\mathcal{S},X}^{\text{vac}}) = \text{id}_{tft_C(\widehat{\mathcal{S}(X)})}$. \square

Definition 4.3. Let $X = (\widetilde{X}, \iota, \delta, b^{\text{in}}, b^{\text{out}}, \text{or})$ be a world sheet and \mathcal{S} be a purely closed sewing of X . The world sheet

$$\text{fl}_{\mathcal{S}}(X) := (\widetilde{X}', \iota', \delta', b^{\text{in}'}, b^{\text{out}'}, \text{or}') \tag{4.15}$$

(the world sheet *filled at* \mathcal{S}) is defined by gluing unmarked disks to all boundary components of \widetilde{X} that are listed in \mathcal{S} :

$$\widetilde{X}' := (\widetilde{X} \sqcup (\mathcal{S} \times D) \sqcup (\mathcal{S} \times D)) / \sim, \tag{4.16}$$

where $D = \{|z| \leq 1\} \subset \mathbb{C}$ is the unit disk. Denoting by $((a, b), z)_k$, $k = 1, 2$, elements of the first and second copy of $\mathcal{S} \times D$, the identification is, for all $(a, b) \in \mathcal{S}$ and $z \in \partial D$, given by $((a, b), z)_1 \sim \delta_a^{-1} \circ C(-z)$ and $((a, b), z)_2 \sim \delta_b^{-1} \circ C(-z)$. The involution ι' is defined to equal ι on \widetilde{X} and as $\iota'(((a, b), z)_k) = ((\iota_*(a), \iota_*(b)), C(-z))_k$ on the disks D . δ' is the restriction of δ to $\partial\widetilde{X}'$, and $b^{\text{in}'}$ and $b^{\text{out}'}$ are the restrictions of b^{in} and b^{out} , respectively, to $\pi_0(\partial\widetilde{X}')$. Finally, or' is defined to be the unique continuous extension of or to $\widetilde{X}'/\langle \iota' \rangle$.

For $(a, b) \in \mathcal{S}$, in a neighbourhood of the circles C_a, C_b , the sewed world sheet $\mathcal{S}(X)$ and the filled world sheet $\text{fl}_{\mathcal{S}}(X)$ look as follows (as usual we draw

the quotient surface)

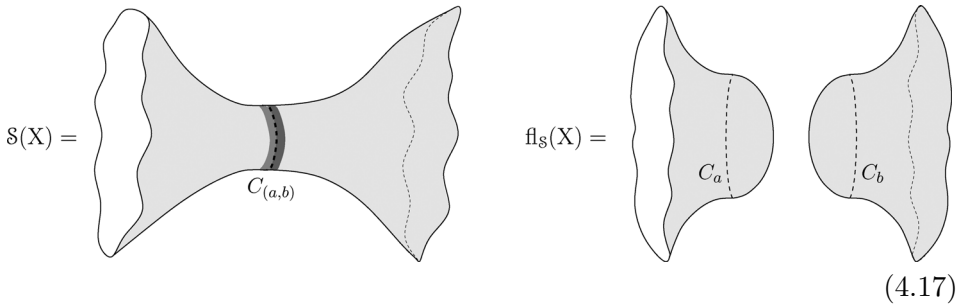

We proceed by defining, for a world sheet X and a purely closed sewing \mathcal{S} , a linear map $E_{\mathcal{S}, X}^{\text{vac}}$ (the symbol E reminds of “embedding”) from $B\ell(\text{fl}_{\mathcal{S}}(X))$ to $B\ell(\mathcal{S}(X))$. Consider the cobordism

$$M_{\mathcal{S}} := \widehat{\text{fl}_{\mathcal{S}}(X)} \times [0, 1] / \sim, \tag{4.18}$$

where the equivalence relation “ \sim ” identifies $((a, b), z)_1 \times \{1\}$ with $((a, b), C(-z))_2 \times \{1\}$ for all points $((a, b), z)$ in $\mathcal{S} \times D$. For $(a, b) \in \mathcal{S}$, in a neighbourhood of the circle $C_{(a,b)}$, $M_{\mathcal{S}}$ looks as follows.

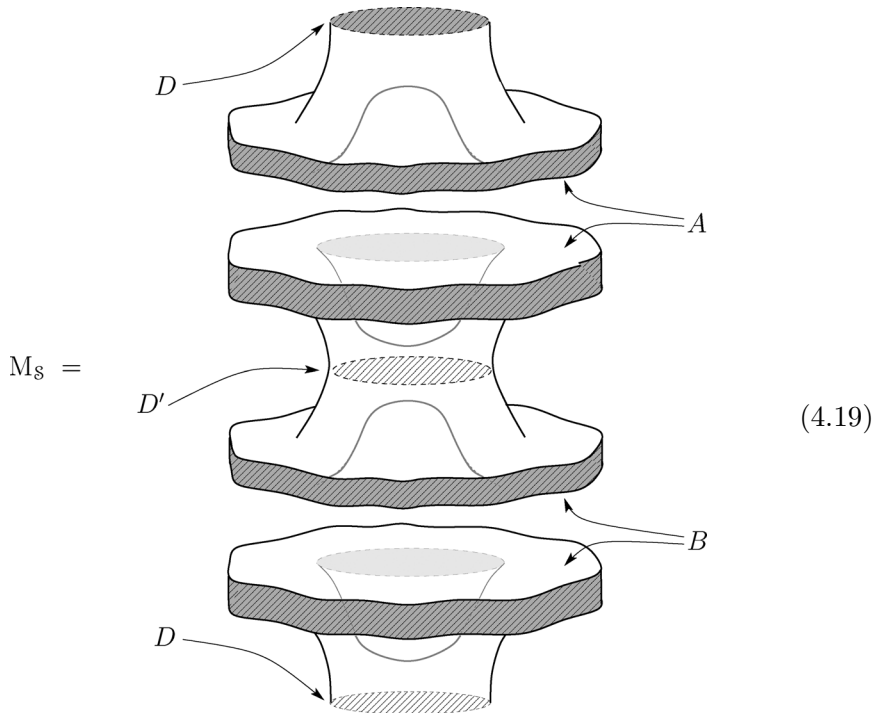

Here the two regions marked D are to be identified. In fact, D and D' are the disks on the boundary of $\widehat{\text{fl}_{\mathcal{S}}(X)} \times [0, 1]$ that get identified in (4.18). The part of the boundary of $M_{\mathcal{S}}$ marked A is the part of the decorated double

$\widehat{\text{fl}}_S(\mathbb{X})$ that corresponds to a neighbourhood of C_a in (4.17), and similarly for B and C_b .

One verifies that with these identifications, M_S is a cobordism from $\widehat{\text{fl}}_S(\mathbb{X})$ to $\widehat{S}(\mathbb{X})$. We then set

$$E_{S,\mathbb{X}}^{\text{vac}} : \text{tft}_{\mathcal{C}}(\widehat{\text{fl}}_S(\mathbb{X})) \longrightarrow \text{tft}_{\mathcal{C}}(\widehat{S}(\mathbb{X})), \quad E_{S,\mathbb{X}}^{\text{vac}} := \text{tft}_{\mathcal{C}}(M_S). \tag{4.20}$$

It is again not difficult to check that $E_{S,\mathbb{X}}^{\text{vac}}$ restricts to a linear map from $Bl(\widehat{\text{fl}}_S(\mathbb{X}))$ to $Bl(\widehat{S}(\mathbb{X}))$. Also, following the same reasoning that led to (4.12), one shows that

$$\aleph(\varphi_{\text{op}}, \varphi_{\text{cl}})_{S(\mathbb{X})} E_{S,\mathbb{X}}^{\text{vac}} = E_{S,\mathbb{X}'}^{\text{vac}} \aleph(\varphi_{\text{op}}, \varphi_{\text{cl}})_{\widehat{\text{fl}}_S(\mathbb{X})}, \tag{4.21}$$

where again the ribbons in the cobordism representing $E_{S,\mathbb{X}}^{\text{vac}}$ are labelled by the data in a solution S , and those for $E_{S,\mathbb{X}'}^{\text{vac}}$ by the data in a solution S' .

The following property of $E_{S,\mathbb{X}}^{\text{vac}}$ will be needed below.

Lemma 4.4. *The linear map $E_{S,\mathbb{X}}^{\text{vac}}: Bl(\widehat{\text{fl}}_S(\mathbb{X})) \rightarrow Bl(\widehat{S}(\mathbb{X}))$ is injective.*

Proof. Let $\widehat{S}(\mathbb{X}) = \bigsqcup_{\beta} L_{\beta}$ be the decomposition of the decorated double $\widehat{S}(\mathbb{X})$ into connected components. Figure (4.17) illustrates that one can easily find examples where $\widehat{\text{fl}}_S(\mathbb{X})$ has more connected components than $\widehat{S}(\mathbb{X})$. Let us write $K^{(\beta)} = \bigsqcup_{\alpha} K_{\alpha}^{(\beta)}$ for the decomposition of the part $K^{(\beta)} \subseteq \widehat{\text{fl}}_S(\mathbb{X})$ that corresponds to the single component L_{β} in $\widehat{S}(\mathbb{X})$. More precisely, $K_{\alpha}^{(\beta)}$ are those connected components of $\widehat{\text{fl}}_S(\mathbb{X})$ for which $\pi_{S,\mathbb{X}}(K_{\alpha}^{(\beta)} \cap \widetilde{\mathbb{X}})$ has nonzero intersection with $L_{\beta} \cap \widetilde{S}(\mathbb{X})$.

By construction, the cobordism M_S in 4.18 then decomposes as $M_S = \bigsqcup_{\beta} M_S^{(\beta)}$, where $M_S^{(\beta)}$ is a cobordism from $K^{(\beta)}$ to L_{β} . To prove the lemma, it is enough to show that all $\text{tft}_{\mathcal{C}}(M_S^{(\beta)})$ are injective. Below we will consider one fixed value of β , so let us abbreviate $L \equiv L_{\beta}$, $K_{\alpha} \equiv K_{\alpha}^{(\beta)}$, $M \equiv M^{(\beta)}$, and set $E = \text{tft}_{\mathcal{C}}(M)$.

Let $K = \bigsqcup_{\alpha} K_{\alpha}$ and let (V_i, ε_i) , $i = 1, 2, \dots, m$, be the labels of the marked arcs of K . Let $T_{\alpha}(\cdot)$ be a handle body for K_{α} (as in formula (3.17)). Then $\text{tft}_{\mathcal{C}}(T_{\alpha}(\cdot))$ defines an isomorphism

$$\text{Hom}(\bigotimes_i^{(\alpha)} V_i^{\varepsilon_i} \otimes H^{\otimes g_{\alpha}}, \mathbf{1}) \xrightarrow{\cong} \text{tft}_{\mathcal{C}}(K_{\alpha}), \tag{4.22}$$

where the tensor product $\bigotimes_i^{(\alpha)}$ extends over all marked arcs (V_i, ε_i) that lie in K_{α} and g_{α} is the genus of K_{α} . A handle body T' for L , on the other hand,

provides an isomorphism

$$tft_{\mathcal{C}}(T'(\cdot)) : \text{Hom}(\bigotimes_i V_i^{\varepsilon_i} \otimes H^{\otimes g_L}, \mathbf{1}) \xrightarrow{\cong} tft_{\mathcal{C}}(\mathbf{L}), \quad (4.23)$$

where the tensor product is over *all* marked arcs (V_i, ε_i) and g_L is the genus of \mathbf{L} .

A crucial observation is now that one can choose $T'(\cdot)$ to be given, as a three-manifold, by $M \circ \bigsqcup_{\alpha} T_{\alpha}(\cdot)$ and choose the ribbons in T' so that

$$tft_{\mathcal{C}}(M \circ (\bigsqcup_{\alpha} T_{\alpha}(f_{\alpha}))) = tft_{\mathcal{C}}(T'((\bigotimes_{\alpha} f_{\alpha}) \otimes (\tilde{d}_{\mathbf{1}})^{\otimes n})), \quad (4.24)$$

where $\tilde{d}_{\mathbf{1}} \in \text{Hom}(\mathbf{1} \otimes \mathbf{1}^{\vee}, \mathbf{1}) = \text{Hom}(\mathbf{1}, \mathbf{1})$ is the duality morphism, and $n = g_K - \sum_{\alpha} g_{\alpha}$ is the number of additional handles arising in the gluing process. By construction, in $M \circ (\bigsqcup_{\alpha} T_{\alpha}(f_{\alpha}))$ there are no ribbons running through these additional handles, and so one obtains the duality $\tilde{d}_{\mathbf{1}}$, interpreted (via the restriction of H to $\mathbf{1} \otimes \mathbf{1}$) as a morphism in $\text{Hom}(H, \mathbf{1})$, for each such handle.

Every vector $v \in tft_{\mathcal{C}}(\mathbf{K})$ can be written as $v = \sum_i tft_{\mathcal{C}}(\bigsqcup_{\alpha} T_{\alpha}(f_{\alpha}^{(i)}))$ for appropriate morphisms $f_{\alpha}^{(i)}$. Thus, invoking also the definition (4.18) of $M_{\mathcal{S}}$, for $E = tft_{\mathcal{C}}(M)$ we obtain

$$E(v) = \sum_i tft_{\mathcal{C}}(M \circ (\bigsqcup_{\alpha} T_{\alpha}(f_{\alpha}^{(i)}))) = tft_{\mathcal{C}}(T'((\sum_i \bigotimes_{\alpha} f_{\alpha}^{(i)}) \otimes (\tilde{d}_{\mathbf{1}})^{\otimes n})). \quad (4.25)$$

Since the latter map is just the isomorphism (4.23), it follows that if we have $E(v) = 0$, then also $(\sum_i \bigotimes_{\alpha} f_{\alpha}^{(i)}) \otimes (\tilde{d}_{\mathbf{1}})^{\otimes n} = 0$, which in turn implies $v = 0$. Hence E is injective. \square

In the sequel we abbreviate by S^2 the following world sheet: $\tilde{S}^2 = S^2 \sqcup (-S^2)$ with S^2 the two-sphere, ι is the permutation of the two components of \tilde{S}^2 , so that $\tilde{S}^2 / \langle \iota \rangle$ is again a two-sphere, and ι is the identification of S^2 with the first factor. The correlator Cor_{S^2} is an element of $tft_{\mathcal{C}}(S^2 \sqcup (-S^2))$. Denoting by B^3 the unit three ball, there is thus a constant $\Lambda_{\mathcal{S}} \in \mathbb{C}$ such that

$$Cor_{S^2} = \Lambda_{\mathcal{S}} tft_{\mathcal{C}}(B^3 \sqcup (-B^3)). \quad (4.26)$$

With these ingredients, we are in a position to state

Proposition 4.5. *Let \mathcal{S} be a solution to the sewing constraints such that $\dim_{\mathbb{C}} \text{Hom}_{\mathcal{C} \otimes \overline{\mathcal{C}}}(\mathbf{1} \times \overline{\mathbf{1}}, H_{\text{cl}}) = 1$ and such that there is at least one nonzero correlator. Then the constant $\Lambda_{\mathcal{S}}$ in (4.26) is nonzero, and for every world sheet X and every purely closed sewing \mathcal{S} of X we have*

$$P_{\mathcal{S}, X}^{\text{vac}} \circ Cor_{\mathcal{S}(X)} = \Lambda_{\mathcal{S}}^{-|\mathcal{S}|/2} E_{\mathcal{S}, X}^{\text{vac}} \circ Cor_{\mathcal{S}(X)}, \quad (4.27)$$

where $|\mathcal{S}|$ is the number of pairs in \mathcal{S} .

Proof. The left-hand side, denoted by L , of (4.27) can be written as

$$L = P_{\mathcal{S}, X}^{\text{vac}} \circ Bl((\mathcal{S}, \text{id})) \circ Cor_X = \text{tft}_C(M_{\mathcal{S}}) \circ Cor_X, \tag{4.28}$$

where the cobordism $M_{\mathcal{S}}: \widehat{X} \rightarrow \widehat{\mathcal{S}}(\widehat{X})$ coincides with the cobordism $\widehat{\mathcal{S}}$ defined in (3.35) everywhere except in the annuli $C_{(a,b)} \times [0, 1]$ created by the sewing $(a, b) \in \mathcal{S}$, where there are additional K -ribbons from $P_{\mathcal{S}, X}^{\text{vac}}$. Specifically, in a neighbourhood of one of the annuli $C_{(a,b)} \times [0, 1]$, $M_{\mathcal{S}}$ looks as follows.

$$\text{tft}_C(M_{\mathcal{S}}) = \sum_{\alpha, \beta} \text{tft}_C(M_{\alpha, \beta}) \tag{4.29}$$

where it is understood that $\text{tft}_C(\cdot)$ is applied to each cobordism shown in the picture; the $(\mathbf{1}, e_{\alpha}, r_{\alpha})$ label a basis for the different ways to realize $\mathbf{1}$ as a retract of B_l , $(\mathbf{1}, \tilde{e}_{\alpha}, \tilde{r}_{\alpha})$ the ways to realize $\mathbf{1}$ as a retract of B_r , and we used (3.20) twice. Since $Cor_X: \mathbb{C} \rightarrow Bl(X)$, we can write

$$L = \text{tft}_C(M_{\mathcal{S}}) \circ Cor_X = \sum_{\alpha, \beta} \text{tft}_C(M_{\alpha, \beta}) \circ P_X \circ Cor_X \tag{4.30}$$

with P_X the projector introduced in (3.33). Since by assumption there is a nonzero correlator, according to Lemma 4.1 the two morphisms $u_{B_{\eta}}$ and $u_{B_{\varepsilon}}$ are both nonzero. Since $\dim_{\mathbb{C}} \text{Hom}_{\mathbb{C} \boxtimes \overline{\mathbb{C}}}(\mathbf{1} \times \overline{\mathbf{1}}, H_{cl}) = 1$, there exist numbers $\lambda_{\alpha\beta}, \tilde{\lambda}_{\alpha\beta} \in \mathbb{C}$ such that

$$\begin{aligned} p_S \circ (e_{\alpha} \times \tilde{r}_{\beta}) &= \lambda_{\alpha\beta} u_{B_{\eta}} \in \text{Hom}_{\mathbb{C} \boxtimes \overline{\mathbb{C}}}(\mathbf{1} \times \overline{\mathbf{1}}, B_l \times \overline{B_r}) \quad \text{and} \\ (r_{\alpha} \times \tilde{e}_{\beta}) \circ p_S &= \tilde{\lambda}_{\alpha\beta} u_{B_{\varepsilon}} \in \text{Hom}_{\mathbb{C} \boxtimes \overline{\mathbb{C}}}(B_l \times \overline{B_r}, \mathbf{1} \times \overline{\mathbf{1}}) \end{aligned} \tag{4.31}$$

with $p_{\mathcal{S}}$ the idempotent in $\text{Hom}(B_l \times \overline{B_r}, B_l \times \overline{B_r})$ introduced in (3.53). This allows us to replace $e_\alpha, \tilde{e}_\beta, r_\alpha, \tilde{r}_\beta$ in each of the terms $tft_{\mathcal{C}}(M_{\alpha,\beta}) \circ P_X$ in the sum (4.30) by the morphisms occurring in the decompositions $u_{B\eta} = \sum_{\gamma} u'_{\gamma} \otimes u''_{\gamma}$ and $u_{B\varepsilon} = \sum_{\delta} n'_{\delta} \otimes n''_{\delta}$, up to the constants $\lambda_{\alpha\beta}$ and $\tilde{\lambda}_{\alpha\beta}$. We can then use (4.7) and the corresponding identity for $u_{B\varepsilon}$ to conclude that

$$L = \lambda^{|\mathcal{S}|/2} E_{\mathcal{S},X}^{\text{vac}} \circ \text{Cor}_{\text{fl}_{\mathcal{S}}(X)}, \quad (4.32)$$

where $|\mathcal{S}|$ is the number of pairs in \mathcal{S} and $\lambda = \sum_{\alpha,\beta} \lambda_{\alpha\beta} \tilde{\lambda}_{\alpha\beta}$. The constant λ is independent of X . In particular, (4.32) must hold if we take X, Y and \mathcal{S} as in Lemma 4.2. Then by Lemma 4.2 we have $L = \text{Cor}_{\mathcal{S}(X)}$, so that in this case (4.32) becomes

$$\text{Cor}_{\mathcal{S}(X)} = \lambda E_{\mathcal{S},X}^{\text{vac}} \circ \text{Cor}_{\text{fl}_{\mathcal{S}}(X)}. \quad (4.33)$$

To establish (4.27) it remains to show that $\lambda = \Lambda_{\mathcal{S}}^{-1}$. Denote by R the right-hand side of (4.33). Since $X = Y \sqcup X_{B\eta}$, the world sheet $\text{fl}_{\mathcal{S}}(X)$ is isomorphic to the union of $\mathcal{S}(X)$ and a copy of S^2 . Inserting the explicit form (4.20) for $E_{\mathcal{S},X}^{\text{vac}}$ and substituting $\text{Cor}_{S^2} = \Lambda_{\mathcal{S}} \text{tft}_{\mathcal{C}}(B^3 \sqcup (-B^3))$, one finds that

$$R = \lambda \Lambda_{\mathcal{S}} \text{Cor}_{\mathcal{S}(X)}. \quad (4.34)$$

Comparing this result with (4.33) and recalling that we may choose $\mathcal{S}(X)$ to be a world sheet with $\text{Cor}_{\mathcal{S}(X)} \neq 0$, it follows that $R \neq 0$ (and hence in particular $\Lambda_{\mathcal{S}} \neq 0$) and that $\lambda = \Lambda_{\mathcal{S}}^{-1}$. Thus L in (4.32) is indeed equal to the right-hand side of (4.27). \square

Remark 4.6. Equation (4.27) is the analogue of the operation on world sheets with metric of taking the limit in which a cylindrical neighbourhood of the image of \mathcal{S} in $\mathcal{S}(X)$ gets infinitely long, such that only the closed state vacuum can “propagate along the cylinder.” Proposition 4.5 also demonstrates that if there is at least one nonzero correlator and if $\dim_{\mathbb{C}} \text{Hom}_{\mathcal{C} \boxtimes \overline{\mathcal{C}}}(\mathbf{1} \times \overline{\mathbf{1}}, H_{\text{cl}}) = 1$, then automatically $\text{Cor}_{S^2} \neq 0$.

4.3 From Frobenius algebras to a solution to the sewing constraints

In [1, 2, 11], a solution to the sewing constraints was explicitly constructed using a symmetric special Frobenius algebra in the category \mathcal{C} . The version of this construction presented here, borrowed from [40], differs from the one in [1, 2, 11] in the respect that we consider only a single boundary condition, and that individual boundary and bulk fields are combined into algebra objects in \mathcal{C} and $\mathcal{C} \boxtimes \overline{\mathcal{C}}$, respectively.

A symmetric special Frobenius algebra in \mathcal{C} is a quintuple $(A, m, \eta, \Delta, \varepsilon)$, where $A \in \text{Obj}(\mathcal{C})$, and m, η, Δ and ε are the multiplication, unit, comultiplication and counit morphisms. These morphisms can be visualized graphically as follows:

$$\begin{array}{cccccc}
 m = & \begin{array}{c} A \\ | \\ \bullet \\ / \quad \backslash \\ A \quad A \end{array} & \eta = & \begin{array}{c} A \\ | \\ \bullet \end{array} & \Delta = & \begin{array}{c} A \quad A \\ \backslash \quad / \\ \bullet \\ | \\ A \end{array} & \varepsilon = & \begin{array}{c} \bullet \\ | \\ A \end{array} & (4.35)
 \end{array}$$

A is an algebra and a coalgebra, i.e., the above morphisms obey

$$\begin{aligned}
 m \circ (m \otimes \text{id}_A) &= m \circ (\text{id}_A \otimes m) && \text{(associativity)} \\
 m \circ (\eta \otimes \text{id}_A) &= \text{id}_A = m \circ (\text{id}_A \otimes \eta) && \text{(unitality)} \\
 (\Delta \otimes \text{id}_A) \circ \Delta &= (\text{id}_A \otimes \Delta) \circ \Delta && \text{(coassociativity)} \\
 (\varepsilon \otimes \text{id}_A) \circ \Delta &= \text{id}_A = (\text{id}_A \otimes \varepsilon) \circ \Delta && \text{(counitality)}
 \end{aligned} \tag{4.36}$$

That A is furthermore symmetric special Frobenius means that

$$\begin{aligned}
 \Delta \circ m &= (m \otimes \text{id}_A) \circ (\text{id}_A \otimes \Delta) = (\text{id}_A \otimes m) \circ (\Delta \otimes \text{id}_A) && \text{(Frobenius)} \\
 ((\varepsilon \circ m) \otimes \text{id}_{A^\vee}) \circ (\text{id}_A \otimes b_A) &= (\text{id}_{A^\vee} \otimes (\varepsilon \circ m)) \circ (\tilde{b}_A \otimes \text{id}_A) && \text{(symmetry)} \\
 \varepsilon \circ \eta &= \dim(A) \text{id}_1 \quad \text{and} \quad m \circ \Delta = \text{id}_A && \text{((normalized) specialness)}
 \end{aligned} \tag{4.37}$$

with $\dim(A) \neq 0$. The relations in (4.36) and (4.37) are shown graphically in [1], Equations (3.2), (3.27), (3.29), (3.31) and (3.33), respectively.

Given a symmetric special⁸ Frobenius algebra A in a ribbon category \mathcal{C} , consider the element

$$P_A^l := \begin{array}{c} A \\ | \\ \curvearrowright \\ | \\ \bullet \\ | \\ \bullet \\ | \\ A \end{array} \tag{4.38}$$

of $\text{Hom}(A, A)$. This is an idempotent (see e.g., [1] Lemma 5.2). It is used in the following

⁸Specialness requires only that the last conditions in (4.37) hold up to nonzero complex numbers. By rescaling morphisms one can choose normalizations such that these constants are 1 and $\dim(A)$, respectively. In the sequel we assume that a special algebra is normalized in this way. Thus from here on “special” stands for “normalized special.”

Definition 4.7. Let A be a symmetric special Frobenius algebra A in an idempotent complete ribbon category \mathcal{C} . The *left centre* $C_l(A)$ of A is a retract $(C_l(A), e_C, r_C)$ of A such that $e_C \circ r_C = P_A^l$.

The left centre is unique up to isomorphism of retracts and satisfies $m \circ c_{A,A} \circ (e_C \otimes \text{id}_A) = m \circ (e_C \otimes \text{id}_A)$, whence the name. Analogously one defines a right centre in terms of a right central idempotent, but we will not need this concept here. More details and references on the left and right centres can be found in [31, Section 2.4].

To describe the space of closed states below, we need a certain algebra in $\mathcal{C} \boxtimes \bar{\mathcal{C}}$. Choose a basis $\{\lambda_{(ij)k}^\alpha\}_\alpha$ in each of the spaces $\text{Hom}(U_i \otimes U_j, U_k)$. Denote by $\{\lambda_{k(ij)}^\alpha\}_\alpha$ the basis of $\text{Hom}(U_k, U_i \otimes U_j)$ that is dual to the former in the sense that $\lambda_{(ij)k}^\alpha \circ \lambda_{l(ij)}^\beta = \delta_{k,l} \delta_{\alpha,\beta} \text{id}_{U_k}$.

Definition 4.8. For \mathcal{C} a modular tensor category, the *canonical trivializing algebra* $T_{\mathcal{C}} \equiv (T_{\mathcal{C}}, m_T, \eta_T)$ in the product category $\mathcal{C} \boxtimes \bar{\mathcal{C}}$ is the algebra with underlying object

$$T_{\mathcal{C}} := \bigoplus_{i \in \mathcal{I}} U_i \times \bar{U}_i \quad (4.39)$$

and with unit morphism η_T defined to be the obvious monic $e_{\mathbf{1} \times \bar{\mathbf{1}}} \prec_{T_{\mathcal{C}}}$, and multiplication m_T defined through its restrictions m_{ij}^k to $\text{Hom}_{\mathcal{C} \boxtimes \bar{\mathcal{C}}}((U_i \times \bar{U}_i) \otimes (U_j \times \bar{U}_j), U_k \times \bar{U}_k)$ by

$$m_{ij}^k := \sum_{\alpha} \lambda_{(ij)k}^\alpha \otimes \overline{\lambda_{k(ij)}^\alpha}. \quad (4.40)$$

As shown in [31], Section 6.3, $T_{\mathcal{C}}$ extends to a haploid commutative symmetric special Frobenius algebra in $\mathcal{C} \boxtimes \bar{\mathcal{C}}$. The qualification “trivializing” derives from the fact that the category of local $T_{\mathcal{C}}$ -modules in $\mathcal{C} \boxtimes \bar{\mathcal{C}}$ is equivalent to \mathcal{Vect} (see [31], Proposition 6.23), but this property will not play a role here. Instead, $T_{\mathcal{C}}$ is instrumental in the

Definition 4.9. For A a symmetric special Frobenius algebra in a modular tensor category \mathcal{C} , the *full centre* $Z(A)$ of A is the object

$$Z(A) := C_l((A \times \mathbf{1}) \otimes T_{\mathcal{C}}) \in \text{Obj}(\mathcal{C} \boxtimes \bar{\mathcal{C}}). \quad (4.41)$$

For this definition to make sense, $(A \times \mathbf{1}) \otimes T_{\mathcal{C}}$ must itself be a symmetric special Frobenius algebra. This is indeed the case, see for example [1], Section 3.5. Moreover, as shown in [40], Appendix, we have

Lemma 4.10. *The full centre $Z(A)$ is a commutative symmetric Frobenius algebra.*

- Remark 4.11.** (i) In a braided monoidal category, there are in fact two inequivalent ways to endow the tensor product $B \otimes C$ of two algebras B and C with an associative product; one can either take $(m_B \otimes m_C) \circ (\text{id}_B \otimes c_{C,B}^{-1} \otimes \text{id}_C)$ or one can use the braiding itself instead of its inverse. Our convention is to use the inverse braiding.
- (ii) To be more precise, in Definition 4.9 we should use the term “left full centre.” There is analogously a right full centre, defined in terms of the right centre $C_r(\cdot)$, if one at the same time uses the other convention for the tensor product $B \otimes C$ of algebras as mentioned in (i). Or one could use the algebra $A \in \text{Obj}(\mathcal{C})$ to obtain an algebra $\bar{A} \in \text{Obj}(\bar{\mathcal{C}})$, and consider $C_{l/r}((\mathbf{1} \times \bar{A}) \otimes T_{\mathcal{C}})$. But these four algebras are related by isomorphism or by exchanging the roles of \mathcal{C} and $\bar{\mathcal{C}}$, and each one determines the other three up to isomorphism. We will work with $Z(A)$ as given in Definition 4.9.
- (iii) In a symmetric tensor category the notions of left and right centres coincide, and in the category of vector spaces they also coincide with the notion of full centre.

Let now again A be a symmetric special Frobenius algebra in a modular tensor category \mathcal{C} . Let the morphisms $e_Z \in \text{Hom}_{\mathcal{C} \boxtimes \bar{\mathcal{C}}}(Z(A), (A \otimes K) \times \bar{K})$ and $r_Z \in \text{Hom}_{\mathcal{C} \boxtimes \bar{\mathcal{C}}}((A \otimes K) \times \bar{K}, Z(A))$ be given by

$$e_Z = \sum_{i \in \mathcal{I}} \text{Diagram}_1 \quad r_Z = \sum_{i \in \mathcal{I}} \text{Diagram}_2 \quad (4.42)$$

where (U_i, e_i, r_i) realizes U_i as a retract of K and $(U_i \times \bar{U}_i, \tilde{e}_i, \tilde{r}_i)$ realizes $U_i \times \bar{U}_i$ as a retract of $T_{\mathcal{C}}$.

Lemma 4.12. $(Z(A), e_Z, r_Z)$ is a retract of $B_l \times \overline{B_r}$ with $B_l = A \otimes K$ and $B_r = K$.

Proof. We have to show that $r_Z \circ e_Z = \text{id}_{Z(A)}$. This can be done by writing out the definitions of r_Z and e_Z and using the identity $r \circ e = \text{id}$ for the various embedding and restriction morphisms that appear in (4.42), as well as $\sum_i e_i \circ r_i = \text{id}_K$. \square

Remark 4.13. In [40] the objects B_l and B_r were both chosen to be $A \otimes K$. Since according to Section 3.5 it is irrelevant how H_{cl} is realized as a retract, this does not affect any of our results.

By choosing

$$H_{\text{op}} := A \quad \text{and} \quad H_{\text{cl}} := Z(A) \quad (4.43)$$

for a symmetric special Frobenius algebra A , we can construct a collection of correlators in the following way. Recall the definition of the connecting manifold M_X in (3.25). Let X be a world sheet and x be a point in \dot{X} . Take $p \in \tilde{X}$ to be a point in the pre-image of $\pi_X: \tilde{X} \rightarrow \dot{X}$, and define a map $I: \dot{X} \rightarrow M_X$ by setting $I(x) := [x, 0]$. The equivalence relation in (3.25) ensures that I is well defined and injective.

To construct the ribbon graph in M_X we first need to choose a directed dual triangulation of \dot{X} not intersecting the images of $b_X^{\text{in}} \cup b_X^{\text{out}}$. Here by the qualification *dual* we mean that all vertices are trivalent, while faces can have an arbitrary number of edges. The (dual) triangulation is constrained such as to cover the physical components of $\partial\dot{X}$ with direction given by the orientation of $\partial\dot{X}$ (taking this direction rather than the opposite one is merely a convention), and such that at each vertex there are both inwards- and outwards-directed edges. The ribbon graph is then constructed as follows:

1. Each edge is covered by a ribbon labelled by the algebra object A , such that the core orientation of the ribbon is opposite to the direction of the corresponding edge, and the 2-orientation is opposite to that of $I(\dot{X})$.
2. A vertex is covered by a coupon labelled by m (respectively, Δ) if there are two in-going edges (respectively, out-going edges) meeting at the vertex.
3. In a neighbourhood of an open state boundary (an interval resulting from $a \in b^{\text{in/out}}$ such that $\iota_*(a) = a$), a ribbon labelled by A is inserted

running from ∂M_X towards $\partial \dot{X}$. If the open state boundary is in-going (respectively, out-going), the core orientation is chosen inwards from (respectively, out towards) ∂M_X . The ribbon is joined to the dual triangulation at $\partial \dot{X}$ by a coupon labelled m (Δ) for an in- (out-)going open state boundary. The two possibilities are displayed in the following picture:

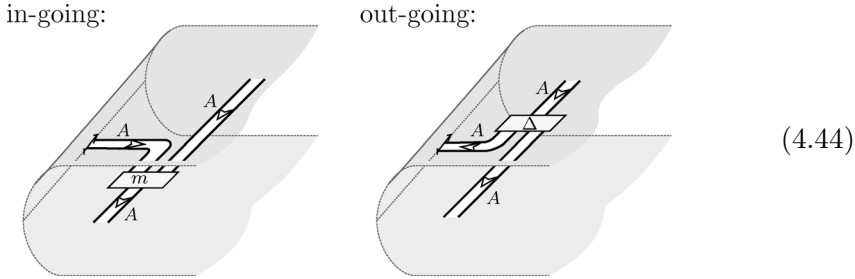

(4.44)

4. For closed state boundaries (circles corresponding to $a \in b^{\text{in/out}}$ such that $\iota_*(a) \neq a$), the prescription is somewhat more involved. Consider the disks D_a and D_b glued to closed state boundary components a and $b = \iota_*(a)$. By definition of the three-manifold M_X , the two cylinders $\{(p, t) \mid p \in D_a, t \in [-1, 1]\}$ and $\{(p, t) \mid p \in D_b, t \in [-1, 1]\}$ are identified. In this cylinder there has to be inserted one of the ribbon graphs shown below, depending on whether the closed state boundary is in- or out-going.

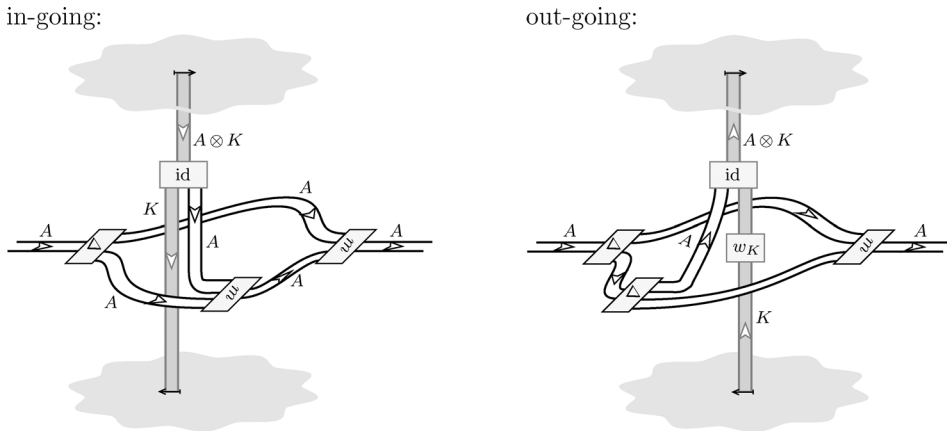

(4.45)

For a given triangulation T , denote the resulting cobordism of extended surfaces by $M_X(T)$. Define a linear map $Cor_{X,T}^A: \mathbb{C} \rightarrow Bl(\mathcal{C}, A, Z(A), A \otimes K, K, e, r)$ by

$$Cor_{X,T}^A := tft_{\mathcal{C}}(M_X(T)). \quad (4.46)$$

It was established in [2]⁹ that $Cor_{X,T}^A = Cor_{X,T'}$ for any two dual triangulations T and T' , and it therefore makes sense to abbreviate $Cor_{X,T}^A$ by Cor_X^A . As further shown in [40], the tuple $(\mathcal{C}, A, Z(A), A \otimes K, A, e_Z, r_Z, Cor^A)$ is a solution to the sewing constraints, i.e., the collection of correlators as defined above gives a monoidal natural transformation. We therefore arrive at the following.¹⁰

Theorem 4.14. *For any symmetric special Frobenius algebra A in a modular tensor category \mathcal{C} , the tuple*

$$S(\mathcal{C}, A) := (\mathcal{C}, A, Z(A), A \otimes K, K, e_Z, r_Z, Cor^A) \quad (4.47)$$

is a solution to the sewing constraints.

Given the solution $S(\mathcal{C}, A)$ to the sewing constraints, we can express the fundamental correlators with the help of morphisms involving the algebra object A . Carrying out the construction described above results in the expressions

$$Cor_{X_a}^A = tft_{\mathcal{C}}(F(X_a, f_a)) \quad \text{for } a \in \{\eta, \varepsilon, m, \Delta, Bb\}, \quad (4.48)$$

where the cobordisms $F(X_a, f_a)$ are those given in figure 4 and the morphisms f_a are determined by A as

$$f_{\eta} = \eta, \quad f_{\varepsilon} = \varepsilon, \quad f_m = m, \quad f_{\Delta} = \Delta \quad \text{and} \quad f_{Bb} = \Phi_A, \quad (4.49)$$

⁹Some of the conventions in [2] differ from those used here. In [2] every edge at a vertex is directed outwards, and subsequently the prescription for constructing the ribbon graph differs from the one given here. Using that A is symmetric, special and Frobenius, it is, however, easily realized that the linear maps obtained after applying the 3D TFT functor to the respective ribbon graphs are equal.

¹⁰As mentioned in the previous footnote, there are slight differences between the prescriptions in [2] and the present paper. But it is straightforward to adapt the proofs in [2]. We refrain from giving the details here; an outline can be found in of [40], Section 3 and Appendix.

with the morphism $\Phi_A \in \text{Hom}(A \otimes A \otimes K, A \otimes K)$ given by

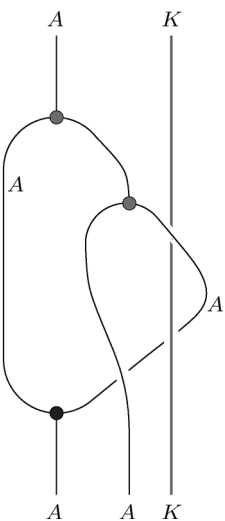
$\Phi_A =$  (4.50)

The expressions for the correlators on $X_{B(1)}$, $X_{B(3)}$ and X_{oo} in terms of A are not required for the calculations below, but we include them here for completeness. It is convenient to use the cobordisms

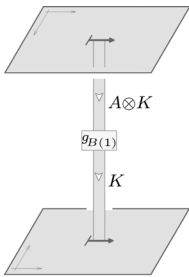
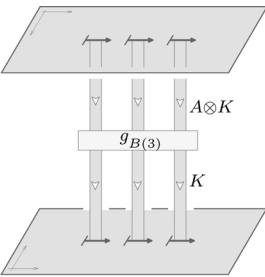
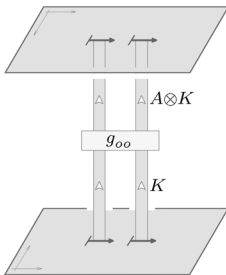
$G_{B(1)}(g_{B(1)}) =$  $G_{B(3)}(g_{B(3)}) =$ 
 $G_{oo}(g_{oo}) =$  (4.51)

In terms of these cobordisms we have $Cor_{X_a}^A = tftc(G_a(g_a))$ for $a \in \{B(1), B(3), \infty\}$, with

$$g_{B(1)} = \text{Diagram} \tag{4.52}$$

and

$$g_{B(3)} = \text{Diagram} \quad g_{\infty} = \text{Diagram} \tag{4.53}$$

- Remark 4.15.** (i) The class of 2D CFTs contains in particular the 2-D TFTs. For TFTs the modular tensor category \mathcal{C} of the present setup is equivalent to \mathcal{Vect} . The data collected in a solution to the sewing constraints can, in this case, be compared to those encoded in a “knowledgeable Frobenius algebra,” that is [24], a quadruple (A, C, ι, ι^*) consisting of a symmetric Frobenius algebra A , a commutative Frobenius algebra C , an algebra homomorphism $\iota: C \rightarrow A$ from C to the center of A and a linear map $\iota^*: A \rightarrow C$ that is uniquely determined by A , C and ι . It has been shown [24] that specifying an open/closed 2D TFT (in the sense of [24]) is equivalent to giving a knowledgeable Frobenius algebra. A 2D TFT (in the sense of [24]) with target category \mathcal{Vect} gives rise to a solution to the sewing constraints for \mathcal{Vect} . However, in general not every solution can be obtained this way, as it is not required that the correlators for X_p and X_{Bp} correspond to invertible morphisms of \mathcal{C} , whereas for a 2D TFT they get automatically mapped to the identity because X_p and X_{Bp} are the identity morphisms in the relevant cobordism category.
- (ii) Going from the special case $\mathcal{C} \simeq \mathcal{Vect}$ to the general situation, we see that A and $Z(A)$ in the solution $S(\mathcal{C}, A)$ remain a symmetric and a commutative Frobenius algebra, respectively. However, A and $Z(A)$ are now objects of different categories, namely of \mathcal{C} and of $\mathcal{C} \boxtimes \overline{\mathcal{C}}$, respectively (in the topological case $\mathcal{C} \simeq \mathcal{Vect}$ the difference is not noticeable because $\mathcal{Vect} \boxtimes \overline{\mathcal{Vect}} \simeq \mathcal{Vect} \boxtimes \mathcal{Vect} \simeq \mathcal{Vect}$).
- (iii) Due to the presence of the scale parameter $\gamma \in \mathbb{C}^\times$ in the definition (3.62), which is motivated by the physical considerations made around (3.58), the notion of equivalence for solutions to the sewing constraints is broader than isomorphism of knowledgeable Frobenius algebras (in the case $\mathcal{C} = \mathcal{Vect}$, when both structures are defined).
- (iv) As pointed out first in [1] (Sections 3.2 and 5.1), the symmetric special Frobenius algebra A used to decorate the triangulation of the world sheet is in fact the same as the algebra of boundary fields for the boundary condition labelled A . In the present formulation this manifests itself in the fact that the correlators on the disks X_η , X_ε , X_m and X_Δ are directly given by the (co)unit and (co)multiplication of A , see formula (4.49).

This effect has also been observed in the special case of 2D TFT [41]. On the other hand, the treatment in [41] is more general than what is obtained by restricting our formalism to $\mathcal{C} = \mathcal{Vect}$. Namely, it is not required that one works over an algebraically closed field, the category \mathcal{Vect} can be replaced by a more general symmetric monoidal category, and the Frobenius algebra used to decorate the triangulation is only demanded to be strongly separable, a slightly weaker condition than symmetric special.

4.4 From a solution to the sewing constraints to a Frobenius algebra

It will be useful to have at our disposal a way to “cut” a world sheet into simpler pieces without having to specify explicitly the parametrization of the newly arising state boundaries of the individual pieces. This is achieved by the next two definitions.

- Definition 4.16.** (i) A *cutting* of a world sheet X is a subset γ of \widetilde{X} such that $\gamma \cap \partial\widetilde{X} = \emptyset$, $\iota_X(\gamma) = \gamma$, and each connected component of γ is homeomorphic to the half-open annulus $1 \leq |z| < 2 \subset \mathbb{C}$.
- (ii) Two cuttings β and γ of a world sheet are *equivalent*, denoted by $\beta \sim \gamma$, iff they contain the same boundary circle, i.e., iff $\partial\beta \cap \beta = \partial\gamma \cap \gamma$.

Note that every connected component of the projection of a cutting to the quotient \dot{X} for a world sheet X either has the topology of an annulus or of a semi-annulus.

Given world sheets X and Y and a morphism $\varpi: X \rightarrow Y$, one obtains a cutting $\Gamma(\varpi)$ of Y as follows. Write $\varpi = (\mathcal{S}, f)$ and choose a small open neighbourhood U of the union of all boundary components b of $\partial\widetilde{X}$ for which $(a, b) \in \mathcal{S}$. By replacing U by $U \cup \iota_X(U)$ if necessary, one can ensure that $\iota_X(U) = U$. We denote by $\Gamma(\varpi)$ the corresponding subset of Y , i.e., set $\Gamma(\varpi) := f \circ \pi_{\mathcal{S}, X}(U) \subset Y$. Different choices for U lead to equivalent cuttings $\Gamma(\varpi)$. Using the operation $\Gamma(\cdot)$ we can formulate

Definition 4.17. A *realization* of a cutting γ of a world sheet X is a world sheet $X|_\gamma$ together with a morphism $c_\gamma: X|_\gamma \rightarrow X$ such that $\Gamma(c_\gamma) \sim \gamma$.

Similarly to the isomorphism Ψ_m in (4.2), for any world sheet X_a of the type a disk with p in- and q out-going open state boundaries we are given an isomorphism

$$\Psi_a: \text{Hom}(H_{\text{op}}^{\otimes p}, H_{\text{op}}^{\otimes q}) \rightarrow \text{tft}_{\mathcal{C}}(\widehat{X}_a). \quad (4.54)$$

Given a solution \mathcal{S} to the sewing constraints, we define $m_{\mathcal{S}}$ to be the unique element of $\text{Hom}(H_{\text{op}} \otimes H_{\text{op}}, H_{\text{op}})$ such that $\text{Cor}_{X_m} = \text{tft}_{\mathcal{C}}(\text{F}(X_m; m_{\mathcal{S}}))$ or, equivalently,

$$m_{\mathcal{S}} = \Psi_m^{-1}(\text{Cor}_{X_m}). \quad (4.55)$$

Analogously we can use the isomorphisms Ψ_x , $x \in \{\eta, \Delta, \varepsilon, p\}$, coming from the corresponding cobordisms in figure 4 to define morphisms $\eta_{\mathcal{S}} \in \text{Hom}(\mathbf{1}, H_{\text{op}})$, $\Delta_{\mathcal{S}} \in \text{Hom}(H_{\text{op}}, H_{\text{op}} \otimes H_{\text{op}})$, $\varepsilon_{\mathcal{S}} \in \text{Hom}(H_{\text{op}}, \mathbf{1})$ and $Q_{\mathcal{S}} \in \text{Hom}$

(H_{op}, H_{op}) via

$$\begin{aligned} \eta_S &:= \Psi_\eta^{-1}(Cor_{X_\eta}), & \Delta_S &:= \Psi_\Delta^{-1}(Cor_{X_\Delta}) \\ \varepsilon_S &:= \Psi_\varepsilon^{-1}(Cor_{X_\varepsilon}), & Q_S &:= \Psi_p^{-1}(Cor_{X_p}). \end{aligned} \tag{4.56}$$

Lemma 4.18. *Let S be a solution to the sewing constraints such that $Q_S \in \text{Hom}(H_{op}, H_{op})$ is an isomorphism. Then $Q_S = \text{id}_{H_{op}}$.*

Proof. Consider the world sheet X_p with a cutting α such that $X_p|_\alpha \cong X_p \sqcup X_p$. Choose a realization of α of the form $c_\alpha: X_p \sqcup X_p \rightarrow X_p$. Naturality of Cor implies

$$Cor_{X_p} = Bl(c_\alpha) \circ (Cor_{X_p} \otimes Cor_{X_p}) = Bl(c_\alpha) \circ tft_{\mathcal{C}}(F(X_p; Q_S) \sqcup F(X_p; Q_S)). \tag{4.57}$$

Expressing $Bl(c_\alpha)$ through a cobordism, and implementing the composition by gluing of cobordisms, implies that the right-hand side of (4.57) equals $tft_{\mathcal{C}}(F(X_p; Q_S \circ Q_S))$. Applying Ψ_p^{-1} results in $Q_S \circ Q_S = Q_S$, i.e., Q_S is an idempotent. But by assumption Q_S is also invertible, hence $Q_S = \text{id}_{H_{op}}$. \square

Proposition 4.19. *Let S be a solution to the sewing constraints such that Q_S is invertible. Then*

$$A_S := (H_{op}, m_S, \eta_S, \Delta_S, \varepsilon_S) \tag{4.58}$$

is a symmetric Frobenius algebra in \mathcal{C} .

Proof. The proof follows the standard route to extract properties of the generating world sheets from different ways of decomposing more complex ones.

- *Unit property.* The relation to be shown is the second relation of (4.36). Consider the cutting α of X_p indicated in

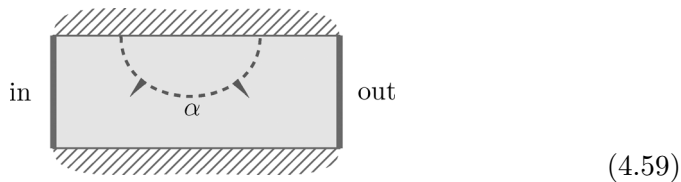

Choose a realization $c_\alpha: X_\eta \sqcup X_m \rightarrow X_p$ of this cutting α . Naturality of Cor implies

$$Cor_{X_p} = Bl(c_\alpha) \circ tft_{\mathcal{C}}(F(X_m; m_S) \sqcup F(X_\eta; \eta_S)). \tag{4.60}$$

Implementing the composition with $Bl(c_\alpha)$ by gluing cobordisms yields

$$Cor_{X_p} = \text{Diagram} \tag{4.61}$$

Applying Ψ_p^{-1} to both sides of this equality and using Lemma 4.18 yields $\text{id}_{H_{op}} = m_S \circ (\text{id}_{H_{op}} \otimes \eta_S)$. That the equality $\text{id}_{H_{op}} = m_S \circ (\eta_S \otimes \text{id}_{H_{op}})$ holds as well can be seen analogously. This establishes the unit property.

- *Associativity.* Next we show the first relation in (4.36). Consider the world sheet X_q for which \dot{X}_q is a disk with three in-going and one out-going open state boundaries, and with cuttings α and β as indicated in

$$X_q = \text{Diagram} \tag{4.62}$$

Let $c_\alpha, c_\beta: X_m \sqcup X_m \rightarrow X_m$ be realizations of α and β , respectively. Naturality implies

$$Cor_{X_q} = Bl(c_\delta) \circ tft_C(F(X_m; m_S) \sqcup F(X_m; m_S)) \tag{4.63}$$

for $\delta = \alpha, \beta$. Evaluating the right-hand side by gluing cobordisms, followed by applying Ψ_q^{-1} , yields the equality

$$m_S \circ (m_S \otimes \text{id}_{H_{op}}) = m_S \circ (\text{id}_{H_{op}} \otimes m_S), \tag{4.64}$$

which is the condition of associativity.

- *Counit property and coassociativity.* The proof of the counit property (the third relation in (4.36)) is analogous to the proof of the unit property, considering instead cuttings α such that $X_p|_\alpha \cong X_\varepsilon \sqcup X_\Delta$.

The proof of coassociativity (the last relation in (4.36)) follows closely the proof of associativity, starting instead with the world sheet of a disk with one in-going and three out-going open state boundaries, and cutting it in two components, each isomorphic to X_Δ .

- *Frobenius property.* The Frobenius condition is the first relation in (4.37). Denote the world sheet of a disk with two in- and two out-going open state boundaries by X_F . Consider two cuttings α, β of X_F ,

as indicated in

$$X_F = \text{[Diagram of a genus-2 surface with cutting lines } \alpha \text{ and } \beta \text{]} \tag{4.65}$$

Note that these cuttings show that $X_F|_\delta$ is isomorphic to $X_m \sqcup X_\Delta$ for $\delta = \alpha, \beta$. Consider realizations $c_\delta: X_m \sqcup X_\Delta \rightarrow X_F$ of the two cuttings $\delta = \alpha, \beta$. Again, by definition of the correlator we have the relation $Cor_{X_F} = Bl(c_\delta) \circ tft_C(F(X_m; m_S) \sqcup F(X_\Delta; \Delta_S))$ for $\delta = \alpha, \beta$. Representing the compositions on the right-hand side as gluing of cobordisms yields the extended cobordisms

$$M_S = \text{[Diagram of a sphere with cobordisms } H_{op}, m_S, \Delta_S \text{]} \quad \text{and} \quad M_{S'} = \text{[Diagram of a sphere with cobordisms } H_{op}, m_S, \Delta_S \text{]} \tag{4.66}$$

Applying Ψ_F^{-1} to each of these cobordisms yields one half of the Frobenius property, namely

$$(\text{id}_{H_{op}} \otimes m_S) \circ (\Delta_S \otimes \text{id}_{H_{op}}) = \Delta_S \circ m_S. \tag{4.67}$$

The other half of the Frobenius property in (4.37) can be seen analogously, by changing the direction of the cutting α in (4.65).

- *Symmetry.* The symmetry condition is the second relation in (4.37). Denote by $X_{p'}$ the world sheet for which $\hat{X}_{p'}$ consists of a disk with two in-going open state boundaries. We make use of the isomorphism $\Psi_{p'}: \text{Hom}(H_{\text{op}} \otimes H_{\text{op}}, \mathbf{1}) \rightarrow \text{tft}_{\mathcal{C}}(\hat{X}_{p'})$. Choose two cuttings α and β according to

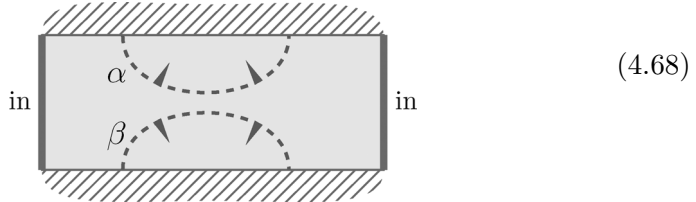

implying that $X_{p'}|_{\alpha, \beta}$ are both isomorphic to $X_m \sqcup X_\varepsilon$. The same procedure as in the previous demonstrations results in the equality

$$\varepsilon_S \circ m_S = d_{H_{\text{op}}} \circ (\text{id}_{H_{\text{op}}^\vee} \otimes (\varepsilon_S \circ m_S) \otimes \text{id}_{H_{\text{op}}}) \circ (\tilde{b}_{H_{\text{op}}} \otimes \text{id}_{H_{\text{op}}} \otimes \text{id}_{H_{\text{op}}}). \tag{4.69}$$

By composing these morphisms with $\text{id}_{H_{\text{op}}} \otimes b_{H_{\text{op}}}$ and using the duality axiom, the result is precisely the symmetry condition in (4.37). \square

Definition 4.20. The Frobenius algebra A_S described in Proposition 4.19 is called the *algebra of open states of S*.

To fix our notation, let us briefly recall the notion of bimodules and bimodule intertwiners.

Definition 4.21. For A an algebra in a tensor category \mathcal{C} , an *A-bimodule* $B = (\dot{B}, \rho_l, \rho_r)$ is a triple consisting of an object \dot{B} and of two morphisms $\rho_l \in \text{Hom}(A \otimes \dot{B}, \dot{B})$ and $\rho_r \in \text{Hom}(\dot{B} \otimes A, \dot{B})$ such that

$$\begin{aligned} \rho_l \circ (\text{id}_A \otimes \rho_l) &= \rho_l \circ (m \otimes \text{id}_{\dot{B}}), & \rho_l \circ (\eta \otimes \text{id}_{\dot{B}}) &= \text{id}_{\dot{B}}, \\ \rho_r \circ (\rho_r \otimes \text{id}_A) &= \rho_r \circ (\text{id}_{\dot{B}} \otimes m), & \rho_r \circ (\text{id}_{\dot{B}} \otimes \eta) &= \text{id}_{\dot{B}}, \\ \rho_l \circ (\text{id}_A \otimes \rho_r) &= \rho_r \circ (\rho_l \otimes \text{id}_A). \end{aligned} \tag{4.70}$$

In other words, an A -bimodule is simultaneously a left A -module and a right A -module, with commuting left and right actions of A . The category $\mathcal{C}_{A|A}$ of A -bimodules has bimodules as objects and intertwiners as

morphisms, i.e., the morphism spaces are

$$\begin{aligned} \text{Hom}_{A|A}(B, C) &:= \{f \in \text{Hom}(\dot{B}, \dot{C}) \mid f \circ \rho_l^B = \rho_l^C \circ (\text{id}_A \otimes f), f \circ \rho_r^B \\ &= \rho_r^C \circ (f \otimes \text{id}_A)\}. \end{aligned} \tag{4.71}$$

An algebra A is called *absolutely simple* iff $\text{Hom}_{A|A}(A, A)$ is one-dimensional.

Proposition 4.22. *Let $S = (\mathcal{C}, H_{\text{op}}, H_{\text{cl}}, B_l, B_r, e, r, \text{Cor})$ be a solution to the sewing constraints such that Q_S is invertible. If $\dim_{\mathbb{C}}(\text{Hom}_{\mathcal{C} \boxtimes \bar{\mathcal{C}}}(\mathbf{1} \times \bar{\mathbf{1}}, H_{\text{cl}})) = 1$, then the algebra A_S of open states of S is absolutely simple.*

Proof. For the sake of brevity, in this proof we write A for A_S . From A one obtains a \mathbb{C} -algebra $A_{\text{top}} = \text{Hom}_{\mathbb{C}}(\mathbf{1}, A)$ by choosing $\eta_{\text{top}}: \mathbf{1} \mapsto \eta$ as unit and $m_{\text{top}}: \alpha \otimes \beta \mapsto m \circ (\alpha \otimes \beta)$ as multiplication, see [1, Section 3.4]. The subalgebra $\text{cent}_A(A_{\text{top}}) := \{\alpha \in A_{\text{top}} \mid m \circ (\alpha \otimes \text{id}_A) = m \circ (\text{id}_A \otimes \alpha)\}$ of A_{top} is called the relative centre [1, Definition 3.15]; we abbreviate it by $\text{cent}_A(A_{\text{top}}) =: C$. It is not difficult to see that the mapping $\alpha \mapsto m \circ (\text{id}_A \otimes \alpha)$ is an isomorphism (with inverse $\varphi \mapsto \varphi \circ \eta$) from C to $\text{Hom}_{A|A}(A, A)$ as vector spaces, so that A is absolutely simple if and only if C is one-dimensional.

Assume now that $\dim_{\mathbb{C}}(C) > 1$. Then one has $m_{\text{top}}(x, y) = 0$ for suitable nonzero elements $x, y \in C$. This is seen by noting that C , being a finite-dimensional commutative associative unital algebra over \mathbb{C} , can be written as a sum of its semisimple part and its Jacobson ideal, see e.g., [42, Chapters I.4 and II.5]. If the Jacobson ideal of C is nontrivial, it contains at least one nilpotent element $n \in C$, so that $m_{\text{top}}(n', n') = 0$ for a suitable nonvanishing power n' of n . If, on the other hand, C is semisimple, then it has a basis $\{p_i \mid i = 1, \dots, \dim_{\mathbb{C}}(C)\}$ consisting of orthogonal idempotents, and we can choose $x = p_1$ and $y = p_2$. It is not hard to see that A_{top} is itself a symmetric Frobenius algebra in Vect (see [1], Lemma 3.14), and $\varepsilon \circ m$ provides a nondegenerate bilinear form on A_{top} ; thus there exists a morphism $\psi_1 \in \text{Hom}(\mathbf{1}, A)$ such that $\varepsilon \circ m \circ (x \otimes \psi_1) \neq 0$, or in other words, $\varepsilon \circ q_1 \neq 0$ for $q_1 := m \circ (x \otimes \psi_1)$. Similarly there is a $q_2 = m \circ (y \otimes \psi_2)$ such that $\varepsilon \circ q_2 \neq 0$.

Consider a world sheet X which is an annulus with one in-going open state boundary on either side,

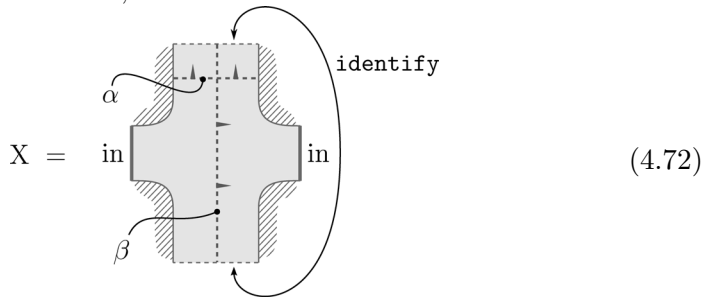

Also indicated in this picture are two cuttings α, β which will be used in the sequel. Construct a cobordism

$$M_{q_1, q_2} := \tag{4.73}$$

by inserting the indicated ribbon graph in the cylinder over \widehat{X} and removing the arc on the out-going boundary. One then finds

$$tft_C(M_{q_1, q_2}) \circ Cor_X = 0. \tag{4.74}$$

To see this, choose a realization $c_\alpha: X|_\alpha \rightarrow X$ of the cutting α . The world sheet $X|_\alpha$ is a disk with four open state boundaries, and the correlator can be represented by (4.54) using the multiplication m of A as described in Section 4.3. The composition with M_{q_1, q_2} then results in the morphism in the first line of the chain of equalities

$$\begin{aligned} m \circ (m \otimes id_A) \circ (q_1 \otimes id_A \otimes q_2) \\ = m \circ (m \otimes id_A) \circ ((m \circ (x \otimes \psi_1)) \otimes id_A \otimes (m \circ (y \otimes \psi_2))) \\ = m \circ (m \otimes id_A) \circ (\psi_1 \otimes id_A \otimes \psi_2) \circ m \circ ((m \circ (x \otimes y)) \otimes id_A) = 0. \end{aligned} \tag{4.75}$$

Here in the first step the definitions of q_1 and q_2 are inserted. The second step uses associativity of A and the fact that $x, y \in C$ so that they commute with all of A . The last step follows since by construction $m \circ (x \otimes y) = m_{top}(x, y) = 0$.

On the other hand, owing to $\dim_C(\text{Hom}_{C \boxtimes \bar{C}}(\mathbf{1} \times \bar{\mathbf{1}}, H_{cl})) = 1$ we can project to the closed state vacuum on the circle indicated by the cutting β . Let $c_\beta: X|_\beta \rightarrow X$ be a realization of the cutting β . Choose $X|_\beta$ such that c_β is of the form (S_β, id) . Then according to Proposition 4.5 we obtain

$$P_{S_\beta, X|_\beta}^{vac} \circ Cor_X = \Lambda_S^{-1} E_{S_\beta, X|_\beta}^{vac} \circ Cor_{fl_{S_\beta}(X|_\beta)}. \tag{4.76}$$

Let X_A be the annulus-shaped world sheet that is obtained by omitting the two open state boundaries from the world sheet (4.72), so that M_{q_1, q_2} is a cobordism from X to X_A . It is easy to see that $tft_C(M_{q_1, q_2}) \circ P_{S_\beta, X|_\beta}^{vac} = P_{S_\beta, X_A|_\beta}^{vac} \circ tft_C(M_{q_1, q_2})$. Combining this equality with (4.74) and denoting the left- and right-hand sides of (4.76) by L and R , respectively, we obtain $0 = tft_C(M_{q_1, q_2}) \circ L = tft_C(M_{q_1, q_2}) \circ R$. But the world sheet $fl_{S_\beta}(X)$ consists of

two disks X_ε with one in-going open state boundary each. Their correlators are $Cor_{X_\varepsilon} = tft_C(F(X_\varepsilon; \varepsilon))$. The cobordism for $tft_C(M_{q_1, q_2}) \circ R$ is thus

$$M_{q_1, q_2} := \text{[Diagram of a solid torus with two disks } X_\varepsilon \text{ and morphisms } q_1, q_2, \varepsilon \text{]} \tag{4.77}$$

The two morphisms $\varepsilon \circ q_1$ and $\varepsilon \circ q_2$ are nonzero by construction, so that (4.77) is a nonzero constant times the invariant of a solid torus with empty ribbon graph, which is nonzero as well, implying that $tft_C(M_{q_1, q_2}) \circ R \neq 0$.

Thus assuming that $\dim_C(C)$ is larger than 1 leads to a contradiction, and hence indeed $\dim_C(C) = 1$, i.e., A is absolutely simple. \square

In a category that is \mathbb{k} -linear, with \mathbb{k} a field, and sovereign (i.e., is monoidal and has left and right dualities which coincide both on objects and on morphisms) and for which $\text{Hom}(\mathbf{1}, \mathbf{1}) = \mathbb{k} \text{id}_1$, there are two notions of dimension for an object U , the left and the right dimension $\dim_{l,r}(U) \in \mathbb{k}$. In a ribbon category, these two dimensions coincide (see e.g., [31, Section 2.1] for more details). Part (ii) of the following statement will be used when proving the properties of A_S below.

Lemma 4.23. *Let A be a symmetric Frobenius algebra in a sovereign \mathbb{k} -linear category with $\text{Hom}(\mathbf{1}, \mathbf{1}) = \mathbb{k} \text{id}_1$.*

- (i) $\dim_l(A) = \dim_r(A)$.
- (ii) Write $\dim(A)$ for $\dim_l(A) = \dim_r(A)$. If A is absolutely simple and $\dim(A) \neq 0$, then A is also special.

Proof. (i) Consider the equalities

$$\varepsilon \circ m \circ \Delta \circ \eta = \text{[Diagrammatic sequence of equalities]} \stackrel{(4)}{=} \dim_l(A) \text{id}_1, \tag{4.78}$$

where (1) is symmetry of A , (2) is the Frobenius property, (3) uses the unit and counit properties and (4) is the definition of the left dimension. Thus one has $\dim_l(A)\text{id}_1 = \varepsilon \circ m \circ \Delta \circ \eta$. A version of the calculation (4.78) in which all pictures are left-right-reflected yields analogously $\dim_r(A)\text{id}_1 = \varepsilon \circ m \circ \Delta \circ \eta$.

(ii) Since for a Frobenius algebra A one has $m \circ \Delta \in \text{Hom}_{A|A}(A, A)$, and the latter space is one-dimensional by assumption, we have $m \circ \Delta = \xi \text{id}_A$ for some $\xi \in \mathbb{k}$. Composing both sides of this equality with $\varepsilon \circ \dots \circ \eta$ gives $\varepsilon \circ m \circ \Delta \circ \eta = \xi \varepsilon \circ \eta$. Thus by (i) we have $\dim(A)\text{id}_1 = \xi \varepsilon \circ \eta$. Since $\dim(A) \neq 0$, also ξ and $\varepsilon \circ \eta$ are nonzero. Thus A is special. \square

With the help of this result we obtain the following corollary to Proposition 4.22.

Corollary 4.24. *Let S be a solution to the sewing constraints with $\dim_{\mathbb{C}}(\text{Hom}_{\mathbb{C}\overline{\mathbb{C}}}(\mathbf{1} \times \overline{\mathbf{1}}, H_{\text{cl}})) = 1$ such that Q_S is invertible. If $\dim(A_S) \neq 0$, then A_S is an absolutely simple symmetric special Frobenius algebra.*

Proof. By Proposition 4.19, A_S is a symmetric Frobenius algebra, by Proposition 4.22 it is absolutely simple, and therefore by Lemma 4.23 it is also special. \square

To apply the construction of Section 4.3 for obtaining a solution to the sewing constraints in terms of a symmetric special Frobenius algebra, we need to impose the normalization condition $m \circ \Delta = \text{id}_A$ on product and coproduct. To account for this condition we introduce the following notion.

Definition 4.25. If S is a solution to the sewing constraints such that the algebra A_S of open states is special with $m_S \circ \Delta_S = \xi \text{id}_{A_S}$, then an algebra A satisfying

$$A \equiv (A, m, \eta, \Delta, \varepsilon) = (A_S, \gamma m_S, \gamma^{-1} \eta_S, \gamma \Delta_S, \gamma^{-1} \varepsilon_S) \quad \text{with} \quad \gamma^2 = \xi^{-1} \tag{4.79}$$

is called a *normalized algebra of open states*.

Note that there are two normalized algebras A_{\pm} of open states, which differ in the choice of sign for γ . However, the corresponding solutions $S(\mathcal{C}, A_+)$ and $S(\mathcal{C}, A_-)$ to the sewing constraints are equivalent, and accordingly we will also speak of “the” normalized algebra of open states below.

For a normalized algebra of open states one computes that indeed $m \circ \Delta = (\gamma m_S) \circ (\gamma \Delta_S) = \gamma^2 \xi \text{id}_A = \text{id}_A$.

4.5 The uniqueness theorem

We have now gathered all the ingredients needed to formulate the following uniqueness result: under natural conditions the algebra of open states of a solution to the sewing constraints determines the solution up to equivalence. In more detail:

Theorem 4.26. *Let \mathcal{C} be a modular tensor category and let $\mathbf{S} = (\mathcal{C}, H_{\text{op}}, H_{\text{cl}}, B_l, B_r, e, r, \text{Cor})$ be a solution to the sewing constraints with the following properties:*

- (i) *Uniqueness of closed state vacuum.* $\dim_{\mathbb{C}} \text{Hom}_{\mathcal{C} \boxtimes \bar{\mathcal{C}}}(\mathbf{1} \times \bar{\mathbf{1}}, H_{\text{cl}}) = 1$.
- (ii) *Nondegeneracy of disk two-point function.* For X_p the unit disk with one in-going and one out-going open state boundary, the correlator Cor_{X_p} corresponds, via the distinguished isomorphism $B\ell(X_p) \cong \text{Hom}_{\mathcal{C}}(H_{\text{op}}, H_{\text{op}})$, to an invertible element in $\text{Hom}_{\mathcal{C}}(H_{\text{op}}, H_{\text{op}})$.
- (iii) *Nondegeneracy of sphere two-point function.* For X_{B_p} the unit sphere with one in-going and one out-going closed state boundary, the correlator $\text{Cor}_{X_{B_p}}$ corresponds, via the distinguished isomorphism $B\ell(X_{B_p}) \cong \text{Hom}_{\mathcal{C} \boxtimes \bar{\mathcal{C}}}(H_{\text{cl}}, H_{\text{cl}})$, to an invertible element in $\text{Hom}_{\mathcal{C} \boxtimes \bar{\mathcal{C}}}(H_{\text{cl}}, H_{\text{cl}})$.
- (iv) *Quantum dimensions.* H_{op} obeys $\dim(H_{\text{op}}) \neq 0$. Further, let A be the normalized algebra of open states for \mathbf{S} ; then for each subobject $U_i \times \bar{U}_j$ of the full centre $Z(A)$ (see Definition 4.9) we have $\dim(U_i) \dim(\bar{U}_j) > 0$.

Then \mathbf{S} is equivalent to $\mathbf{S}(\mathcal{C}, A)$, with A the normalized algebra of open states of \mathbf{S} .

Remark 4.27. (i) Condition (iv) in the theorem is a technical requirement needed in the proof. It might be possible that by a different method of proof the above theorem could be established without imposing (iv).

Also note that (iv) is always fulfilled if all quantum dimensions in \mathcal{C} are positive. But it is in fact a much weaker condition. Consider for example the case of nonunitary Virasoro minimal models, and let \mathcal{C} be the relevant representation category. In this category some simple objects have negative quantum dimension (given e.g., in [43, Section 10.6]). Nonetheless Theorem 4.26 can be applied e.g., in the case $H_{\text{op}} = \mathbf{1}$, where it implies that $\mathbf{S}(\mathcal{C}, \mathbf{1})$ is the unique solution to the sewing constraints with $H_{\text{op}} = \mathbf{1}$ and obeying (i)–(iii). Condition (iv) is satisfied because $Z(A)$ only contains objects of the form $U_i \times \bar{U}_i$, and $\dim(U_i)^2 > 0$ holds trivially (as quantum dimensions of simple objects in a modular tensor category over \mathbb{C} are nonzero and real, see [44, Section 2.1 and Corollary 2.10]).

- (ii) Suppose the modular tensor category \mathcal{C} has the property that $\theta_i = \theta_j$ implies $\dim(U_i) \dim(U_j) > 0$. Then the second part of condition (iv) is automatically satisfied. Indeed, it follows from [1, Theorem 5.1] (see the explanation before Lemma 5.9 below for more details) that $U_i \times \overline{U_j}$ can be a subobject of $Z(A)$ only if $\theta_i = \theta_j$.
- (iii) If any one of the conditions (i), (ii) or (iii) in the theorem is removed, the conclusion does not hold any longer. When omitting (i), one can construct a solution such that correlators on world sheets that contain a closed state boundary and a physical boundary vanish identically on some subobject of H_{cl} . H_{cl} then has a part that entirely decouples from the boundary and that therefore cannot be reconstructed from the algebra of open states. An example of this type for $\mathcal{C} = \text{Vect}$ can be found in [41, Example 2.19].

When dropping either (ii) or (iii), one can choose H_{op} or H_{cl} “too big” at the cost of $\text{Cor}(X_p)$ or $\text{Cor}(X_{Bp})$ not corresponding to invertible morphisms (i.e., they are idempotents with nontrivial kernel). For example, given a simple symmetric Frobenius algebra A in a category \mathcal{C} with properties as in Theorem 4.26, the solution $S(\mathcal{C}, A)$ obeys (i)–(iii). From $S(\mathcal{C}, A)$ we can construct, for any nonzero $U \in \text{Obj}(\mathcal{C})$, another solution $S' = (\mathcal{C}, A \oplus U, Z(A), A \otimes K, K, e_Z, r_Z, \text{Cor}')$ with Cor' defined as follows. Let (A, e_A, r_A) be the realization of A as a retract of $A \oplus U$. Then we set $\text{Cor}'_X := F_X(r_A, e_A, \text{id}, \text{id}) \circ \text{Cor}_X^A$ with $F_X(\cdot)$ as defined in (3.27). One verifies that S' is again a solution, that it obeys (i) and, since it coincides with $S(\mathcal{C}, A)$ in the absence of open state boundaries, satisfies (iii) as well. However, S' violates (ii), because $\Psi_p^{-1}(\text{Cor}'_{X_p}) = e_A \circ r_A$, which is not invertible. An example that violates (iii) but not (ii) can be constructed along similar lines with a little more work.

- (iv) The analysis of [20] and, in the case of 2D TFT, the results of [24, 39] show that in order to ensure that a given assignment of correlators to the fundamental world sheets results in a solution to the sewing constraints, only a finite number of relations needs to be verified. This set of relations arises by cutting certain genus-0 and genus-1 world sheets in different ways into fundamental world sheets. In particular, one needs relations from genus-1 world sheets (but no relations from genus 2 or higher). If one is interested only in solutions that satisfy the physically meaningful conditions (i)–(iii) above, then Theorem 4.26 implies that it is enough to fix a simple symmetric Frobenius algebra A as the algebra of open states. Note that the data and the relations for A involve only disk correlators at genus 0 with up to four open state boundaries. The correlators on world sheets of higher genus and/or with closed state boundaries are then determined by A up to equivalence, and they are guaranteed to also

solve the genus-1 relations, and the relations involving closed states boundaries.

- (v) In the case of 2D TFT, i.e., for $\mathcal{C} \simeq \mathcal{Vect}$, the statement of the theorem becomes trivial. Indeed, let (A, C, ι, ι^*) be a knowledgeable Frobenius algebra over \mathbb{C} satisfying condition (i), which simply means that $C \cong \mathbb{C}$ (conditions (ii) and (iii) are implicit in the definition of the 2D TFT associated to a knowledgeable Frobenius algebra). Then by proposition 4.22 A is absolutely simple and hence has trivial centre, $Z(A) = \mathbb{C}\eta$. It follows that there is a unique choice for ι , and thereby also for ι^* . Thus for absolutely simple A any two knowledgeable Frobenius algebras (A, C, ι, ι^*) and $(A, C', \iota', \iota'^*)$ with one-dimensional C and C' are isomorphic.
- (vi) A result analogous to Theorem 4.26 has been obtained for CFTs on 1+1-dimensional Minkowski space in the framework of local quantum field theory [17]. According to [17, Proposition 2.9] a local net of observables on the Minkowski half-space $M_+ = \{(x, t) \mid x \geq 0\}$ gives rise to a (nonlocal) net of observables on the boundary $\{x=0\}$. Conversely, given such a net of observables on the boundary, there is a maximal compatible local net on M_+ . In fact, there can be more than one compatible net on M_+ , but they are all contained in the maximal one. This nonuniqueness stems from the fact that in this setting there is no reason to impose modular invariance.

In our context, i.e., treating the combinatorial aspects of constructing a euclidean CFT from a given chiral one, we start from assumptions which are much weaker than those used in local quantum field theory. In particular, the category \mathcal{C} is not a C^* -category, and it is not concretely realized in terms of a net of subfactors. Consequently the methods from operator algebra which are instrumental in [17] are not applicable. On the other hand, in the 1+1-dimensional setting the analogues of the assumptions of Theorem 4.26 are consequences of the common axioms of local quantum field theory.

5 Proof of the uniqueness theorem

Throughout this section we fix a solution $\mathbf{S} = (\mathcal{C}, H_{\text{op}}, H_{\text{cl}}, B_l, B_r, e_{\mathbf{S}}, r_{\mathbf{S}}, \text{Cor})$ to the sewing constraints and assume that \mathbf{S} obeys the conditions of the uniqueness theorem, Theorem 4.26. Then, due to conditions (i) and (ii) in Theorem 4.26, Proposition 4.22 and Corollary 4.24 apply, so that the algebra of open states for \mathbf{S} is special. It therefore makes sense to consider the normalized algebra of open states, as in Definition 4.25. In the rest of

this section we denote the normalized algebra of open states for S by A . In particular, as objects in \mathcal{C} we have $A = H_{\text{op}}$.

Let us first give a brief outline of the proof. We want to establish equivalence of the given solution $S \equiv (\mathcal{C}, H_{\text{op}}, H_{\text{cl}}, B_l, B_r, e_S, r_S, \text{Cor})$ and $S(\mathcal{C}, A)$. According to Definition 3.17 this amounts to the construction of isomorphisms φ_{op}^A between H_{op} and A as objects of \mathcal{C} and φ_{cl}^A between H_{cl} and $Z(A)$ as objects of $\mathcal{C} \boxtimes \bar{\mathcal{C}}$, and to showing the equality $\text{Cor} = G^\gamma \circ \aleph(\varphi_{\text{op}}^A, \varphi_{\text{cl}}^A) \circ \text{Cor}^A$, with G^γ the natural transformation introduced in Lemma 3.15 and a normalization factor γ as given in Definition 4.25. We construct a candidate morphism $\varphi_{\text{cl}}^A \in \text{Hom}(H_{\text{cl}}, Z(A))$ in section 5.1, and then show in Sections 5.2 and 5.3, respectively, that it is both a monomorphism and an epimorphism. Furthermore, it turns out that for φ_{op}^A we may simply take the identity $\text{id}_{H_{\text{op}}}$, so that it remains to show that $\text{Cor} = G^\gamma \circ \aleph(\text{id}_{H_{\text{op}}}, \varphi_{\text{cl}}^A) \circ \text{Cor}^A$. In Section 5.4 we demonstrate that indeed we have

$$\text{Cor}_{Y_\mu} = G^\gamma \circ \aleph(\text{id}_{H_{\text{op}}}, \varphi_{\text{cl}}^A) \circ \text{Cor}_{Y_\mu}^A \quad (5.1)$$

for all *fundamental* world sheets Y_μ as given in table 2. By Lemma 3.16 the equality then holds in fact for *all* world sheets, thus completing the proof.

5.1 A morphism φ_{cl}^A from H_{cl} to $Z(A)$

To define the morphism φ_{cl}^A , we first need to recall the concept of α -induced bimodules.

Definition 5.1. Let A be an algebra in a braided tensor category \mathcal{C} and U an object in \mathcal{C} . The two A -bimodules $A \otimes^\pm U \equiv (A \otimes U, m \otimes \text{id}_U, \rho_r^\pm)$ are obtained by defining the left A -action via the product m and the right A -action via m and the braiding, according to

$$\rho_r^+ := (m \otimes \text{id}_U) \circ (\text{id}_A \otimes c_{U,A}) \quad \text{and} \quad \rho_r^- := (m \otimes \text{id}_U) \circ (\text{id}_A \otimes c_{A,U}^{-1}). \quad (5.2)$$

Two tensor functors $\alpha_A^\pm: \mathcal{C} \rightarrow \mathcal{C}_{A|A}$ are obtained by mapping objects $U \in \text{Obj}(\mathcal{C})$ to $A \otimes^\pm U$ and morphisms $f \in \text{Hom}(U, V)$ to $\text{id}_A \otimes f \in \text{Hom}_{A|A}(A \otimes^\pm U, A \otimes^\pm V)$. These functors have been dubbed α -*induction*, and accordingly the bimodules $A \otimes^\pm U = \alpha_A^\pm(U)$ are called α -induced bimodules.

The following result will be used below to prove the properties of φ_{cl}^A .

Lemma 5.2. *Let A be a symmetric special Frobenius algebra in a modular tensor category \mathcal{C} and U, V objects of \mathcal{C} . Then for any morphism*

$\Phi \in \text{Hom}_{A|A}(A \otimes^+ U, A \otimes^- V)$ one has

(5.3)

Proof. Similarly as in [31, Proof of Proposition 3.6] we can write

(5.4)

The first step follows by using the unit property followed by the Frobenius property. In the second step the intertwining property of Φ is implemented, and the third step uses again the Frobenius and unit properties. In the fourth step the symmetry property is applied, and the fifth step follows by first pulling the right A -line below the left one to the left and then cancelling the resulting twist and inverse twist. The final equality holds by specialness. \square

We denote by $\Phi_S \in \text{Hom}(A \otimes B_l, A \otimes B_r)$ the unique morphism such that

$$\text{Cor}_{X_{Bb}} = \text{tft}_C(F(X_{Bb}; \Phi_S)). \tag{5.5}$$

The following properties of Φ_S prove to be important.

Lemma 5.3. (i) Φ_S is a bimodule morphism, $\Phi_S \in \text{Hom}_{A|A}(A \otimes^+ B_l, A \otimes^- B_r)$.

(ii) Expanding $p_S = e_S \circ r_S$ as $p_S = \sum_{\alpha} p'_{\alpha} \otimes p''_{\alpha}$ we have $\sum_{\alpha} (\text{id}_A \otimes p''_{\alpha}) \circ \Phi_S \circ (\text{id}_A \otimes p'_{\alpha}) = \Phi_S$.

Proof. (i) Consider the world sheet

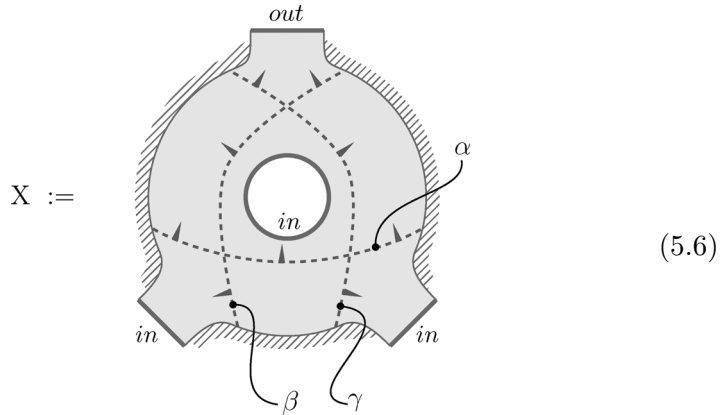

i.e., a disk with two in-going and one out-going open state boundaries and one in-going closed state boundary. In the picture we also indicate three different cuttings α , β and γ . With the help of the cobordism

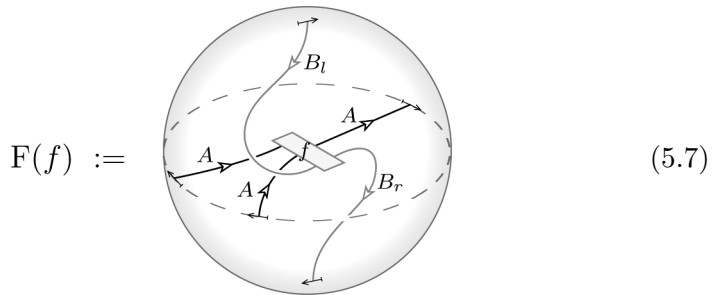

we obtain an isomorphism $f \mapsto \text{tft}_C(F(f))$ from $H := \text{Hom}(A \otimes A \otimes B_l, A \otimes B_r)$ to $\text{tft}_C(\widehat{X})$. Let $c \in H$ be the unique morphism such that $\text{tft}_C(F(c)) = \text{Cor}_X$.

For $\delta \in \{\alpha, \beta, \gamma\}$ every realization $X|_\delta$ of the cutting δ is isomorphic to $X_m \sqcup X_{Bb}$. Denote by $q_\delta: X_m \sqcup X_{Bb} \rightarrow X$ a choice of realization. Then

$$\text{Cor}_X = \text{Bl}(q_\delta) \circ (\text{Cor}_{X_m} \otimes \text{Cor}_{X_{Bb}}) = \text{Bl}(q_\delta) \circ \text{tft}_C(F(X_m; m) \sqcup F(X_{Bb}; \Phi_S)). \tag{5.8}$$

Expressing also $\text{Bl}(q_\delta)$ on the right-hand side of this equality as a cobordism and comparing with (5.7) yields three different expressions for c :

$$\begin{aligned} \text{from } q_\alpha : c &= \Phi_S \circ (m \otimes \text{id}_{B_l}), \\ \text{from } q_\beta : c &= (m \otimes \text{id}_{B_r}) \circ (\text{id}_A \otimes c_{A, B_r}^{-1}) \circ (\Phi_S \otimes \text{id}_A) \circ (\text{id}_A \otimes c_{B_l, A}^{-1}), \\ \text{from } q_\gamma : c &= (m \otimes \text{id}_{B_r}) \circ (\text{id}_A \otimes \Phi_S). \end{aligned} \tag{5.9}$$

It is not difficult to see that equality of these three expressions is equivalent to assertion (i).

(ii) By definition we have $Cor_{X_{Bb}} \in Bl(X_{Bb})$, so that $P_{X_{Bb}} \circ Cor_{X_{Bb}} = Cor_{X_{Bb}}$. The statement then follows by substituting the explicit form of $P_{X_{Bb}}$ in terms of the cobordism (3.33). \square

The following construction will be useful when working with morphisms in $\mathcal{C} \boxtimes \bar{\mathcal{C}}$. Let V, V' be objects of \mathcal{C} and U_k a simple object of \mathcal{C} . Choose bases $e_\alpha \in \text{Hom}(U_k, V)$ and $r_\alpha \in \text{Hom}(V, U_k)$ such that $(U_k, e_\alpha, r_\alpha)$ is a retract of V and $r_\alpha \circ e_\beta = \delta_{\alpha,\beta} \text{id}_{U_k}$. Similarly choose $e'_\alpha \in \text{Hom}(U_k, V')$ and $r'_\alpha \in \text{Hom}(V', U_k)$ to be bases of retracts.

Lemma 5.4. *For every $f \in \text{Hom}(V, V')$ we have the identity*

$$\sum_\alpha (r'_\alpha \times \overline{e'_\alpha}) \circ (f \times \text{id}_{\overline{V'}}) = \sum_\beta (r_\beta \times \overline{e_\beta}) \circ (\text{id}_V \times \overline{f}). \tag{5.10}$$

for morphisms in $\mathcal{C} \boxtimes \bar{\mathcal{C}}$.

Proof. Since U_k is simple, there are constants $\lambda(f)_{\delta\gamma} \in \mathbb{C}$ such that

$$r'_\delta \circ f \circ e_\gamma = \lambda(f)_{\delta\gamma} \text{id}_{U_k}. \tag{5.11}$$

Composing the left-hand side of (5.10) from the right with $e_\gamma \times \overline{r'_\delta}$ one finds

$$(r'_\delta \circ f \circ e_\gamma) \times \text{id}_{\overline{U_k}} = \lambda(f)_{\delta\gamma} \text{id}_{U_k} \times \text{id}_{\overline{U_k}}, \tag{5.12}$$

while the same manipulation of the right-hand side results in

$$\text{id}_{U_k} \times (\overline{e_\gamma} \circ \overline{f} \circ \overline{r'_\delta}) = \text{id}_{U_k} \times \overline{(r'_\delta \circ f \circ e_\gamma)} = \lambda(f)_{\delta\gamma} \text{id}_{U_k} \times \text{id}_{\overline{U_k}}, \tag{5.13}$$

where the second equality uses the definition of composition in $\bar{\mathcal{C}}$. Thus the left and right sides of formula (5.10) are equal when composed with $e_\gamma \times \overline{r'_\delta}$, for any choice of γ and δ . Since the latter morphisms form a basis of $\text{Hom}_{\mathcal{C} \boxtimes \bar{\mathcal{C}}}(U_k \times \overline{U_k}, V \times \overline{V'})$, we have indeed equality already in the form (5.10). \square

Let $e_{i\alpha}$ and $r_{i\alpha}$, for $\alpha = 1, \dots, \dim_{\mathbb{C}}(\text{Hom}(U_i, B_r))$, be embedding and restriction morphisms for the various ways to realize U_i as a retract of B_r . To define $\varphi_{\text{cl}}^A \in \text{Hom}_{\mathcal{C} \boxtimes \bar{\mathcal{C}}}(H_{\text{cl}}, Z(A))$, the essential ingredient is the morphism

Φ_S which allows one to replace B_l by B_r ; we set

$$\varphi_{\text{cl}}^A := \gamma^2 \sum_{i,\alpha} \text{Diagram} \tag{5.14}$$

where γ^2 is the normalization constant from Definition 4.25 and r_C is the restriction morphism in the realization of $Z(A)$ as a retract of $(A \times \bar{1}) \otimes T_C$, see Definitions 4.7 and 4.9. To define the natural isomorphism (3.42) we also need the corresponding morphism in $\text{Hom}(B_l \times \bar{B}_r, (A \otimes K) \times \bar{K})$. Let us abbreviate

$$\phi_{\text{cl}}^A := e_Z \circ \varphi_{\text{cl}}^A \circ r_S, \tag{5.15}$$

with e_Z as introduced in (4.42). Recalling that $\text{Hom}(B_l \times \bar{B}_r, (A \otimes K) \times \bar{K}) = \text{Hom}(B_l, A \otimes K) \otimes_{\mathbb{C}} \text{Hom}(K, B_r)$, we have

Lemma 5.5. *We have $\phi_{\text{cl}}^A = \gamma^2 \sum_{i,\alpha} \phi'_{i\alpha} \otimes \phi''_{i\alpha}$ with $\phi'_{i\alpha} = (\text{id}_A \otimes (e_i \circ r_{i\alpha})) \circ \Phi_S \circ (\eta \otimes \text{id}_{B_l})$ and $\phi''_{i\alpha} = e_{i\alpha} \circ r_i$, where e_i, r_i realize U_i as a retract of K .*

Proof. First recall that we denote the morphisms realizing $U_i \times \bar{U}_i$ as a retract of T_C by \tilde{e}_i and \tilde{r}_i , and note that the morphism $e_Z \circ r_C \circ (\text{id}_{A \times 1} \otimes \tilde{e}_i)$

can be rewritten as

$$e_Z \circ r_C \circ (\text{id}_{A \times \mathbf{1}} \otimes \tilde{e}_i) = \begin{array}{c} (A \otimes K) \times \overline{\mathbf{1}} \quad \mathbf{1} \times \overline{K} \\ \begin{array}{|c|} \hline e_i \\ \hline \end{array} \quad \begin{array}{|c|} \hline \tilde{r}_i \\ \hline \end{array} \\ \begin{array}{|c|} \hline \bullet \\ \hline \end{array} \begin{array}{|c|} \hline \bullet \\ \hline \end{array} \\ \begin{array}{|c|} \hline A \\ \hline \end{array} \\ \begin{array}{|c|} \hline \bullet \\ \hline \end{array} \\ (A \otimes U_i) \times \overline{\mathbf{1}} \quad \mathbf{1} \times \overline{U}_i \end{array} \quad (5.16)$$

where first the explicit form (4.42) of e_Z is inserted, and then $e_C \circ r_C$ is replaced by the projector P_A^l . One then uses that $\tilde{r}_i \circ \tilde{e}_i = \text{id}_{U_i \times \overline{U}_i}$ and that objects of the form $V \times \mathbf{1}$ are transparent to objects of the form $\mathbf{1} \times \overline{W}$. With the help of (5.16) we obtain

$$\phi_{\text{cl}}^A = \gamma^2 \sum_{i,\alpha,\beta} \begin{array}{c} (A \otimes K) \times \overline{K} \quad \mathbf{1} \times \overline{K} \\ \begin{array}{|c|} \hline e_i \\ \hline \end{array} \quad \begin{array}{|c|} \hline \tilde{r}_i \\ \hline \end{array} \\ \begin{array}{|c|} \hline \bullet \\ \hline \end{array} \begin{array}{|c|} \hline \bullet \\ \hline \end{array} \\ \begin{array}{|c|} \hline U_i \\ \hline \end{array} \\ \begin{array}{|c|} \hline r_{i\beta} \\ \hline \end{array} \quad \begin{array}{|c|} \hline \tilde{e}_{i\beta} \\ \hline \end{array} \\ \begin{array}{|c|} \hline B_r \\ \hline \end{array} \\ \begin{array}{|c|} \hline \Phi_{\mathfrak{S}} \\ \hline \end{array} \\ \begin{array}{|c|} \hline B_l \\ \hline \end{array} \\ \begin{array}{|c|} \hline p_\alpha \\ \hline \end{array} \quad \begin{array}{|c|} \hline \overline{p}_\alpha \\ \hline \end{array} \\ B_l \times \overline{\mathbf{1}} \quad \mathbf{1} \times \overline{B_r} \end{array} = \gamma^2 \sum_{i,\alpha,\beta} \begin{array}{c} (A \otimes K) \times \overline{K} \quad \mathbf{1} \times \overline{K} \\ \begin{array}{|c|} \hline e_i \\ \hline \end{array} \quad \begin{array}{|c|} \hline \tilde{r}_i \\ \hline \end{array} \\ \begin{array}{|c|} \hline U_i \\ \hline \end{array} \\ \begin{array}{|c|} \hline r_{i\beta} \\ \hline \end{array} \quad \begin{array}{|c|} \hline \tilde{e}_{i\beta} \\ \hline \end{array} \\ \begin{array}{|c|} \hline B_r \\ \hline \end{array} \\ \begin{array}{|c|} \hline p'_\alpha \\ \hline \end{array} \\ \begin{array}{|c|} \hline B_r \\ \hline \end{array} \\ \begin{array}{|c|} \hline \Phi_{\mathfrak{S}} \\ \hline \end{array} \\ \begin{array}{|c|} \hline B_l \\ \hline \end{array} \\ \begin{array}{|c|} \hline p_\alpha \\ \hline \end{array} \\ B_l \times \overline{\mathbf{1}} \quad \mathbf{1} \times \overline{B_r} \end{array} = \gamma^2 \sum_{i,\alpha} \phi'_{i\alpha} \otimes \phi''_{i\alpha}. \quad (5.17)$$

Here in the first equality (5.16) is substituted, in the second equality Lemma 5.4 is applied for the case $f = p''_\alpha \in \text{Hom}(B_r, B_r)$ and Lemma 5.2 (which applies because by Lemma 5.3 (i) $\Phi_{\mathfrak{S}}$ is an intertwiner of bimodules) is used to omit the A -loop. The final equality amounts to Lemma 5.3 (ii). \square

5.2 φ_{cl}^A is a monomorphism

Denote by D the world sheet such that $\tilde{D}/\langle \iota \rangle$ is the unit disk. Cutting D as $q: X_\eta \sqcup X_\varepsilon \rightarrow D$ shows that

$$\text{Cor}_D = \text{Bl}(q) \circ (\text{Cor}_{X_\eta} \otimes \text{Cor}_{X_\varepsilon}) = \text{tft}_C \left(\begin{array}{c} \text{---} \\ \begin{array}{|c|} \hline \gamma \cdot \varepsilon \\ \hline \end{array} \\ \begin{array}{|c|} \hline A \\ \hline \end{array} \\ \begin{array}{|c|} \hline \gamma \cdot \eta \\ \hline \end{array} \\ \text{---} \end{array} \right) = \gamma^2 \dim(A) \text{tft}_C(B^3). \quad (5.18)$$

Since A is special it follows in particular that $Cor_D \neq 0$. Next consider the cylindrical word sheet X_{Bp} from figure 2 and define \tilde{p}_S to be the unique element of $\text{Hom}_{\mathcal{C}\boxtimes\bar{\mathcal{C}}}(B_l \times \bar{B}_r, B_l \times \bar{B}_r)$ such that upon expanding $\tilde{p}_S = \sum_{\alpha} \tilde{p}'_{S,\alpha} \otimes \tilde{p}''_{S,\alpha}$ we have

$$Cor_{X_{Bp}} = \sum_{\alpha} \text{tft}_c(F(X_{Bp}; \tilde{p}'_{S,\alpha}, \tilde{p}''_{S,\alpha}), \tag{5.19}$$

where $F(X_{Bp}; \cdot, \cdot)$ is the corresponding cobordism from figure 4.

Lemma 5.6. *The endomorphisms \tilde{p}_S and $p_S = e_S \circ r_S$ are equal, $\tilde{p}_S = p_S$.*

Proof. By the nondegeneracy of the sphere two-point function (i.e., property (iii) in Theorem 4.26), \tilde{p}_S is invertible on the image of the idempotent p_S . By definition, $\text{Im}(p_S) = H_{cl}$, so that $r_S \circ \tilde{p}_S \circ e_S$ is an invertible element of $\text{Hom}_{\mathcal{C}\boxtimes\bar{\mathcal{C}}}(H_{cl}, H_{cl})$. Analogously as in formula (4.57), by cutting the world sheet X_{Bp} along its circumference via a morphism $q: X_{Bp} \sqcup X_{Bp} \rightarrow X_{Bp}$ one obtains the identity $Cor_{X_{Bp}} = Bl(q) \circ (Cor_{X_{Bp}} \otimes Cor_{X_{Bp}})$. Together with (5.19) it follows that

$$\tilde{p}_S \equiv \sum_{\alpha} \tilde{p}'_{S,\alpha} \otimes \tilde{p}''_{S,\alpha} = \sum_{\alpha,\beta} (\tilde{p}'_{S,\alpha} \circ \tilde{p}'_{S,\beta}) \otimes (\tilde{p}''_{S,\beta} \circ \tilde{p}''_{S,\alpha}) = \tilde{p}_S \circ \tilde{p}_S, \tag{5.20}$$

i.e., \tilde{p}_S is an idempotent. Furthermore, since the right-hand side of (5.19) is in $Bl(X_{Bp})$, by definition of Bl it follows that $p_S \circ \tilde{p}_S \circ p_S = \tilde{p}_S$. Hence we have, using also $e_S = p_S \circ e_S$,

$$(r_S \circ \tilde{p}_S \circ e_S) \circ (r_S \circ \tilde{p}_S \circ e_S) = r_S \circ \tilde{p}_S \circ p_S \circ \tilde{p}_S \circ e_S = r_S \circ \tilde{p}_S \circ e_S. \tag{5.21}$$

Since $r_S \circ \tilde{p}_S \circ e_S$ is invertible, it follows that in fact $r_S \circ \tilde{p}_S \circ e_S = \text{id}_{H_{cl}}$. Finally, composing with e_S and r_S yields $\tilde{p}_S = p_S$. \square

Next we analyse the properties of the correlator on the world sheet

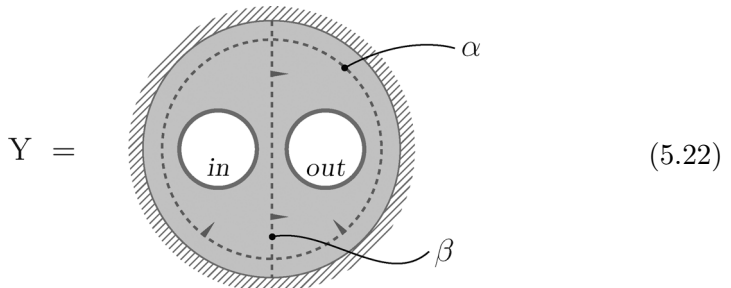

i.e., on a disk with an additional in-going and an additional out-going closed state boundary. The dashed lines in the picture indicate two cuttings α and

β of Y . Consider the cobordisms

$$\tilde{M}^{\text{vac}} := \text{[Diagram 1]} \quad \text{and} \quad N(\psi, \psi') := \text{[Diagram 2]} \tag{5.23}$$

and set $\tilde{P}^{\text{vac}} := \text{tft}_C(\tilde{M}^{\text{vac}})$. For $\varphi = \sum_{\alpha} \varphi'_{\alpha} \otimes \varphi''_{\alpha}$ with $\varphi \in \text{Hom}_{C \boxtimes C}(U_i \times \overline{U}_j, B_l \times \overline{B}_r)$ define further

$$R_{\varphi} := \sum_{\alpha} \text{tft}_C(N(\varphi'_{\alpha}, \varphi''_{\alpha})). \tag{5.24}$$

Note that the cobordism defining \tilde{P}^{vac} differs from the one defining $P^{\text{vac}}_{S_{\alpha}, Y|_{\alpha}}$ (see (4.9)) only in the labelling of ribbons. Consider now the cobordism for (each term of the sum in) the composition $\tilde{P}^{\text{vac}} \circ R_{\varphi}$. By moving the coupons labelled φ'_{α} and φ''_{α} through the annular K -ribbons one verifies the equality $\tilde{P}^{\text{vac}} \circ R_{\varphi} = R_{\varphi} \circ P^{\text{vac}}_{S_{\alpha}, Y|_{\alpha}}$. Suppose now further that $p_S \circ \varphi = \varphi$. Then together with (4.27) and (5.18) it follows that

$$\Lambda_S \tilde{P}^{\text{vac}} \circ R_{\varphi} \circ \text{Cor}_Y = R_{\varphi} \circ E^{\text{vac}}_{S_{\alpha}, Y|_{\alpha}} \circ \text{Cor}_{D \sqcup X_{B_p}}$$

$$= \gamma^2 \dim(A) \sum_{\alpha, \beta} \text{[Diagram 3]} = \gamma^2 \dim(A) \sum_{\alpha} \text{[Diagram 4]} \tag{5.25}$$

where it is understood that tft_C is applied to each cobordism. The last expression in this chain of equalities is zero iff $\varphi = 0$. We conclude that $R_{\varphi} \circ \text{Cor}_Y = 0$ implies $\varphi = 0$.

Next consider the cutting β in (5.22). We find

$$R_\varphi \circ \text{Cor}_Y = R_\varphi \circ \text{Bl}((S_\beta, \text{id})) \circ \text{Cor}_{Y|\beta} = R_\varphi \circ \text{tft}_c \left(\text{Diagram} \right) \quad (5.26)$$

Here the morphism $\tilde{\Phi}_S$ on the right-hand side is analogous to Φ_S , but with an out-going closed state boundary instead of an in-going one. Combining (5.26) with the information that $R_\varphi \circ \text{Cor}_Y = 0$ implies $\varphi = 0$ we obtain

$$\sum_\alpha \begin{array}{c} A \quad U_j \\ | \\ \boxed{\varphi''_\alpha} \\ | \\ \boxed{\Phi_S} \\ | \\ \circ \\ | \\ \boxed{\varphi'_\alpha} \\ | \\ U_i \end{array} = 0 \text{ for all } i, j \in \mathcal{I} \implies R_\varphi \circ \text{Cor}_Y = 0 \implies \varphi = 0. \quad (5.27)$$

We have now gathered all ingredients needed to prove the following.

Lemma 5.7. *The morphism φ_{cl}^A defined in (5.14) is a monomorphism.*

Proof. We will show that $e_Z \circ \varphi_{\text{cl}}^A \circ \psi = 0$ implies $\psi = 0$ for any $\psi \in \text{Hom}_{\mathcal{C} \boxtimes \bar{\mathcal{C}}} (U_i \times \bar{U}_j, H_{\text{cl}})$ and $i, j \in \mathcal{I}$; this implies that φ_{cl}^A is a monomorphism.

Decompose $\varphi := e_S \circ \psi \in \text{Hom}_{\mathcal{C} \boxtimes \bar{\mathcal{C}}} (U_i \times \bar{U}_j, B_l \times \bar{B}_r)$ as $\varphi = \sum_\alpha \varphi'_\alpha \otimes \varphi''_\alpha$. Using Lemma 5.5 to rewrite the combination $\phi_{\text{cl}}^A = e_Z \circ \varphi_{\text{cl}}^A \circ r_S$ appearing in $e_Z \circ \varphi_{\text{cl}}^A \circ \psi = e_Z \circ \varphi_{\text{cl}}^A \circ r_S \circ e_S \circ \psi$ gives

$$e_Z \circ \varphi_{\text{cl}}^A \circ \psi = \gamma^2 \sum_\alpha \sum_{k, \beta} \begin{array}{c} A \times \bar{1}K \times \bar{1} \quad 1 \times \bar{K} \\ | \quad | \\ \boxed{e_k} \quad \boxed{\bar{r}_k} \\ | \quad | \\ U_k \times \bar{1} \quad 1 \times \bar{U}_k \\ | \quad | \\ \boxed{r_{k\beta}} \quad \boxed{\bar{e}_{k\beta}} \\ | \quad | \\ B_r \times \bar{1} \quad 1 \times \bar{B}_r \\ | \quad | \\ \boxed{\Phi_S} \quad | \\ | \quad | \\ \circ \quad | \\ | \quad | \\ \boxed{\varphi'_\alpha} \quad \boxed{\varphi''_\alpha} \\ | \quad | \\ U_i \times \bar{1} \quad 1 \times \bar{U}_j \end{array} = \gamma^2 \sum_\alpha \begin{array}{c} A \times \bar{1}K \times \bar{1} \quad 1 \times \bar{K} \\ | \quad | \\ \boxed{e_j} \quad \boxed{\bar{r}_j} \\ | \quad | \\ U_j \times \bar{1} \quad 1 \times \bar{U}_j \\ | \quad | \\ \boxed{\varphi'_\alpha} \quad | \\ | \quad | \\ B_r \times \bar{1} \quad | \\ | \quad | \\ \boxed{\Phi_S} \quad | \\ | \quad | \\ \circ \quad | \\ | \quad | \\ \boxed{\varphi'_\alpha} \quad | \\ | \quad | \\ U_i \times \bar{1} \quad 1 \times \bar{U}_j \end{array} \quad (5.28)$$

where the second equality holds owing to Lemma 5.4, applied to $f = \varphi''_\alpha \in \text{Hom}(B_r, U_j)$. Since $\text{id}_{A \times 1} \otimes (e_j \times \bar{r}_j)$ is a monomorphism, $e_Z \circ \varphi_{\text{cl}}^A \circ \psi = 0$ implies that the morphism displayed on the left-hand side of (5.27) is zero. This, in turn, again by (5.27), implies that $\varphi = e_S \circ \psi = 0$. Finally, since e_S is a monomorphism as well, we arrive at $\psi = 0$. \square

5.3 φ_{cl}^A is an epimorphism

The following assertion is the algebraic analogue of the statement that the torus partition function of a rational CFT is a modular invariant combination of characters. We denote by h the $|\mathcal{I}| \times |\mathcal{I}|$ -matrix with entries $h_{ij} \in \mathbb{Z}_{\geq 0}$ defined by the decomposition $H_{cl} \cong \bigoplus_{i,j} (U_i \times \overline{U}_j)^{\oplus h_{ij}}$. Then we have

Lemma 5.8. *The matrix h obeys $[s, h] = 0$ and $[t, h] = 0$, where s is the $|\mathcal{I}| \times |\mathcal{I}|$ -matrix given in (3.11), and t is the $|\mathcal{I}| \times |\mathcal{I}|$ -matrix with entries $t_{ij} = \theta_i \delta_{i,j}$.*

Proof. We show $[s, h] = 0$; that $[t, h]$ is zero as well is seen in a similar manner, and we skip the details.

Let Y be the world sheet such that $\tilde{Y} = T^2 \sqcup (-T^2)$ is the union of two tori with opposite orientation and ι_Y the involution that exchanges the two tori. On Y we consider the two cuttings

$Y =$



(5.29)

For $c_\gamma: X_{Bp} \rightarrow Y$ a realization of the cutting γ we have

$Cor_Y = Bl(c_\gamma) \circ Cor_{X_{Bp}} = \sum_{\alpha} tft_C \left($

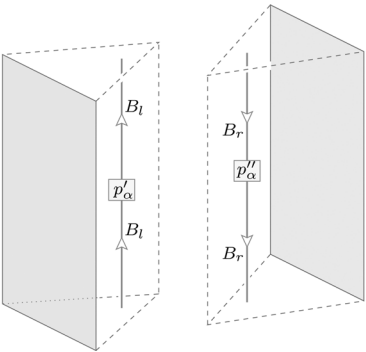

$\left. \right) (5.30)$

The manifolds shown on the right-hand side are two solid tori in the “wedge presentation” for three-manifolds with boundary, i.e., the top and bottom faces are identified, as are the two side faces drawn in dashed lines (for more details on the wedge presentation, see [2, Section 5.1]); also, unlike in figure 2, here and below we suppress the symbol “ \sqcup ” indicating the disjoint sum of the two components. In the second step of (5.30) $Bl(c_\gamma)$ and $Cor_{X_{Bp}}$ are replaced by their representations in terms of cobordisms, and

also (5.19) and Lemma 5.6 are used. The morphisms p'_α and p''_α are again those appearing in the expansion of $p_S = e_S \circ r_S$ as $p_S = \sum_\alpha p'_\alpha \otimes p''_\alpha$.

Let $(U_i \times \overline{U}_j, e'_{ij}, r'_{ij})$ for $\nu = 1, 2, \dots, h_{ij}$ be realizations of the simple sub-objects of H_{cl} as retracts, so that $r'_{ij} \circ e'_{ij} = \delta_{\mu,\nu} \text{id}_{U_i \times \overline{U}_j}$ and $\text{id}_{H_{cl}} = \sum_{i,j,\nu} e'_{ij} \circ r'_{ij}$. Defining $\tilde{e}'_{ij} := e_S \circ e'_{ij}$ and $\tilde{r}'_{ij} := r'_{ij} \circ r_S$ and expanding $\tilde{e}'_{ij} = \sum_\alpha \tilde{e}'_{ij,\alpha} \otimes \tilde{e}''_{ij,\alpha}$ and $\tilde{r}'_{ij} = \sum_\beta \tilde{r}'_{ij,\beta} \otimes \tilde{r}''_{ij,\beta}$ allows us to write

$$p_S = e_S \circ r_S = \sum_{i,j,\nu,\alpha,\beta} (\tilde{e}'_{ij,\alpha} \circ \tilde{r}''_{ij,\beta}) \otimes_{\mathbb{C}} (\tilde{e}''_{ij,\alpha} \circ \tilde{r}'_{ij,\beta}). \tag{5.31}$$

Substituting into (5.30) we get

$$\begin{aligned}
 & \sum_{\alpha} \text{[Diagram 1]} = \sum_{i,j,\nu,\alpha,\beta} \text{[Diagram 2]} \\
 & = \sum_{i,j,\nu,\alpha,\beta} \text{[Diagram 3]} = \sum_{i,j} h_{ij} \text{[Diagram 4]}
 \end{aligned}
 \tag{5.32}$$

where it is again understood that tft_C is applied to each cobordism, and in the second step the morphisms e' and e'' are moved along the vertical direction through the identification region so as to appear below r' and r'' , respectively. The third step amounts to the identity $\tilde{r}'_{ij} \circ \tilde{e}'_{ij} = r'_{ij} \circ r_S \circ e_S \circ e'_{ij} = \text{id}_{U_i \times \overline{U}_j}$, summed over $\nu = 1, \dots, h_{ij}$.

Carrying out the same calculation for the cutting β in (5.30) leads to the cobordism

$$Cor_Y = \sum_{i,j} h_{ij} \left(\text{Diagram 1} \right) \left(\text{Diagram 2} \right) \tag{5.33}$$

for Cor_Y . Composing the expression for Cor_Y obtained in (5.32) with the linear form

$$\left(\text{Diagram 3} \right) \left(\text{Diagram 4} \right) \in \text{tft}_C(T^2 \sqcup -T^2)^* \tag{5.34}$$

results in two copies of $S^2 \times S^1$, with invariant $\sum_{i,j} \delta_{k,i} h_{ij} \delta_{j,l} = h_{k,l}$. On the other hand, performing the same manipulation on the expression in (5.33) yields two copies of S^3 with embedded Hopf links (one with labels k, i and one with labels j, \bar{l}), resulting in the invariant $\text{Dim}(\mathcal{C})^{-1} \sum_{i,j} s_{ki} h_{ij} s_{j\bar{l}} = \text{Dim}(\mathcal{C})^{-1} (shs)_{k\bar{l}}$. For more details on the invariants resulting from glueing tori, see [13, Appendix A.3]; the factor $\text{Dim}(\mathcal{C})^{-1}$ appears as a consequence of $\text{tft}_C(S^3) = \text{Dim}(\mathcal{C})^{-1/2}$. Comparing the two results we get $h_{jl} = \text{Dim}(\mathcal{C})^{-1} (shs)_{j\bar{l}}$. Using further that $\sum_{b \in \mathcal{I}} s_{a,b} s_{b,c} = \text{Dim}(\mathcal{C}) \delta_{a,\bar{c}}$ then yields $h s = s h$ and hence proves the claim. \square

Now recall that by A we denote the normalized algebra of open states for S and that A is special and absolutely simple. Further, as objects in $\mathcal{C} \boxtimes \bar{\mathcal{C}}$ we have $Z(A) \cong \bigoplus_{i,j} (U_i \times \bar{U}_j)^{\oplus z_{ij}}$ for some $z_{ij} \equiv z(A)_{ij} \in \mathbb{Z}_{\geq 0}$. By combining [40, Equation (3.5) and Appendix A] with [1, Theorem 5.1] and [31, Remark 2.8 (i)] it follows that $[s, z(A)] = 0$ and that $z(A)_{00} = 1$. Comparison with the previous analyses then leads to

Lemma 5.9. *The morphism φ_{cl}^A defined in (5.14) is an epimorphism.*

Proof. Since by Lemma 5.7 there is a monomorphism from H_{cl} to $Z(A)$, the integers h_{ij} defined in Lemma 5.8 satisfy $h_{ij} \leq z_{ij}$ for all $i, j \in \mathcal{I}$. By Proposition 4.22 and uniqueness of the closed state vacuum (property (i) in Theorem 4.26), A is absolutely simple and hence $z_{00} = 1$. The matrix

$D := z - h$ thus obeys $D_{00} = 0$, $D_{kl} \geq 0$ for all $k, l \in \mathcal{I}$, and $[s, D] = 0$. It follows that

$$0 = D_{00} = (\text{Dim } \mathcal{C})^{-1} \sum_{k, l \in \mathcal{I}} s_{0k} D_{kl} s_{l0} = \sum_{k, l \in \mathcal{I}} \dim(U_k) \dim(U_l) D_{kl}. \quad (5.35)$$

Since $D_{kl} \leq z_{kl}$, the sum is only over those pairs k, l for which $U_k \times \overline{U}_l$ is a subobject of $Z(A)$. Combining (5.35) with the positivity assumption in condition (iv) of Theorem 4.26, it follows that each coefficient D_{kl} in the sum on the right-hand side vanishes, i.e., that $D \equiv 0$. Thus $h_{ij} = z_{ij}$ for all $i, j \in \mathcal{I}$, and hence the monomorphism φ_{cl}^A is also an epimorphism. \square

5.4 Equivalence of solutions

As data in Theorem 4.26 we are given a solution $\mathbf{S} = (\mathcal{C}, H_{\text{op}}, H_{\text{cl}}, B_l, B_r, e_{\mathbf{S}}, r_{\mathbf{S}}, \text{Cor})$ to the sewing constraints. Using the normalized algebra A of open states of \mathbf{S} we obtain another solution $\mathbf{S}(\mathcal{C}, A) \equiv (\mathcal{C}, A, Z(A), A \otimes K, K, e_Z, r_Z, \text{Cor}^A)$ via Theorem 4.14.

We will show that these two solutions are actually equivalent in the sense of Definition 3.17. More specifically, an equivalence between \mathbf{S} and $\mathbf{S}(\mathcal{C}, A)$ is provided by the isomorphism $\varphi_{\text{cl}}^A \in \text{Hom}_{\mathcal{C} \boxtimes \overline{\mathcal{C}}}(H_{\text{cl}}, Z(A))$ studied in Sections 5.1–5.3 together with

$$\varphi_{\text{op}}^A := \text{id}_A \in \text{Hom}(H_{\text{op}}, A), \quad (5.36)$$

with the number γ appearing in Definition 3.17 given as in (4.79). Let us abbreviate $\aleph \equiv \aleph(\text{id}_A, \varphi_{\text{cl}}^A)$, as well as $B\ell \equiv B\ell(\mathcal{C}, H_{\text{op}}, H_{\text{cl}}, B_l, B_r, e, r)$ and $B\ell^A \equiv B\ell(\mathcal{C}, A, Z(A), A \otimes K, K, e_Z, r_Z)$, and similarly for $P_{\mathbf{S}, X}^{\text{vac}}$ and $E_{\mathbf{S}, X}^{\text{vac}}$ versus $P_{\mathbf{S}, X}^{\text{vac}, A}$ and $E_{\mathbf{S}, X}^{\text{vac}, A}$. For having an equivalence, by Lemma 3.16 it suffices to establish that

$$\text{Cor}_X = \gamma^{2\chi(X)} \aleph_X \circ \text{Cor}_X^A \quad (5.37)$$

for the selection of fundamental world sheets given in figure 2. Below we describe how to obtain (5.37) for each of these world sheets.

- X_η and X_ε : According to (4.79) the unit morphisms η of A and $\eta_{\mathbf{S}}$ of H_{op} are related by $\eta_{\mathbf{S}} = \gamma\eta$. Using also that $\chi(X_\eta) = \frac{1}{2}$ and $\aleph_{X_\eta} = \text{id}_{B\ell(X_\eta)}$, we thus immediately have

$$\text{Cor}_{X_\eta} = \text{tft}_{\mathcal{C}}(\text{F}(X_\eta; \gamma\eta)) = \gamma \text{tft}_{\mathcal{C}}(\text{F}(X_\eta; \eta)) = \gamma^{2\chi(X_\eta)} \text{Cor}_{X_\eta}^A. \quad (5.38)$$

The calculation for X_ε follows analogously from $\varepsilon_{\mathbf{S}} = \gamma\varepsilon$.

- X_m and X_Δ : We have $m_S = \gamma^{-1}m$, $\chi(X_m) = -\frac{1}{2}$ and $\aleph_{X_m} = \text{id}_{Bl(X_m)}$, so that

$$\text{Cor}_{X_m} = \text{tftc}(F(X_m; \gamma^{-1}m)) = \gamma^{-1} \text{tftc}(F(X_m; m)) = \gamma^{2\chi(X_m)} \text{Cor}_{X_m}^A. \tag{5.39}$$

For X_Δ the calculation is analogous.

- X_{Bb} : We have $\chi(X_{Bb}) = -1$; the natural transformation (3.42) is given by $\aleph_{X_{Bb}} = \gamma^2 \sum_{i,\alpha} \text{tftc}(N_{Bb,i\alpha})$ with the cobordisms

$$N_{Bb,i\alpha} = \text{Diagram} \tag{5.40}$$

where $\gamma^2 \sum_{i,\alpha} \phi'_{i\alpha} \otimes \phi''_{i\alpha} = \phi_{cl}^A = e_Z \circ \varphi_{cl}^A \circ r_S$ as in Lemma 5.5. With this information one verifies that

$$\aleph_{X_{Bb}} \circ \text{Cor}_{X_{Bb}}^A = \gamma^2 \sum_{i,\alpha} \text{tftc}(N_{Bb,i\alpha}) \circ \text{tftc}(F(X_{Bb}; \Phi_A)) = \gamma^2 \text{tftc}(F(X_{Bb}; u)), \tag{5.41}$$

where the morphism $u \in \text{Hom}(A \otimes B_l, A \otimes B_r)$ is given by

$$u = \sum_{i,\alpha} \text{Diagram} = \sum_{i,\alpha} \text{Diagram} = \text{Diagram} = \Phi_S. \tag{5.42}$$

Here in the second step the expressions for $\phi'_{i\alpha}$ and $\phi''_{i\alpha}$ as given in Lemma 5.5 is substituted, as well as the expression (4.50) for Φ_A . In the third step the various embedding and restriction morphisms are cancelled. The Frobenius and unit properties of A is used to replace the encircled coproduct by $(m \otimes \text{id}_A) \circ (\text{id}_A \otimes (\Delta \circ \eta))$; the resulting multiplication is moved upwards past the top multiplication morphism. In

the final step the A -loop is omitted using (5.3), and then the encircled multiplication morphism is moved past Φ_S using that, according to Lemma 5.3 (i), Φ_S is an intertwiner of bimodules. Thus altogether we obtain

$$\gamma^{-2}\aleph_{X_{Bb}} \circ Cor_{X_{Bb}}^A = tftc(F(X_{Bb}; \Phi_S)) = Cor_{X_{Bb}}, \tag{5.43}$$

in accordance with (5.37).

- X_{Bp} : (This is not among the fundamental world sheets listed in figure 2, but below we will need the equivalence of correlators on X_{Bp} .) Combining Lemma 5.6 and equation (5.19) we see that $Cor_{X_{Bp}} = \sum_{\alpha} tftc(F(X_{Bp}; p'_{\alpha}, p''_{\alpha}))$, where $e_S \circ r_S = p_S = \sum_{\alpha} p'_{\alpha} \otimes p''_{\alpha}$. By writing out the explicit form of the cobordisms, one checks that

$$\aleph_{X_{Bp}} \circ Cor_{X_{Bp}}^A = \sum_{\beta} tftc(F(X_{Bp}; q'_{\beta}, q''_{\beta})), \tag{5.44}$$

where $q = \sum_{\beta} q'_{\beta} \otimes q''_{\beta}$ is given by

$$q = e_S \circ (\varphi_{cl}^A)^{-1} \circ r_Z \circ e_Z \circ \varphi_{cl}^A \circ r_S = e_S \circ r_S = p_S. \tag{5.45}$$

Thus $Cor_{X_{Bp}} = \aleph_{X_{Bp}} \circ Cor_{X_{Bp}}^A$.

- $X_{B(\ell)}$: Denote by $X_{B(\ell)}$ the world sheet given by a sphere with ℓ in-going closed state boundaries. Let Y be a disk with ℓ in-going closed state boundaries and consider the following two cuttings:

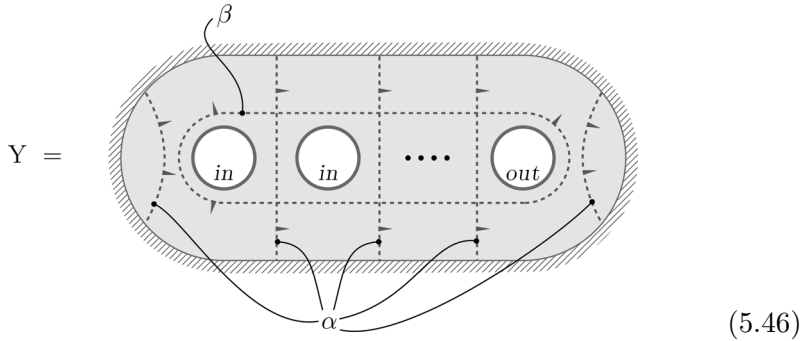

$Y|_{\alpha}$ is isomorphic to $X_{\eta} \sqcup X_{Bb} \sqcup \dots \sqcup X_{Bb} \sqcup X_{\varepsilon}$. By the previous results and Lemma 3.16 we can thus conclude that

$$Cor_Y = \gamma^{2-2\ell} \aleph_Y \circ Cor_Y^A. \tag{5.47}$$

Now apply $P_{S_{\beta}, Y|_{\beta}}^{vac}$ to both sides of this equality. Using Proposition 4.5 one finds

$$\begin{aligned} P_{S_{\beta}, Y|_{\beta}}^{vac} \circ Cor_Y &= \Lambda_S^{-1} E_{S_{\beta}, Y|_{\beta}}^{vac} \circ Cor_{\mathfrak{H}_{S_{\beta}}(Y|_{\beta})} \\ &= \Lambda_S^{-1} E_{S_{\beta}, Y|_{\beta}}^{vac} \circ Bl(q) \circ Cor_{D \sqcup X_{B(\ell)}} \end{aligned} \tag{5.48}$$

for the left-hand side, where $q = (\emptyset, f): D \sqcup X_{B(\ell)} \rightarrow \text{fl}_{S_\beta}(Y|_\beta)$ is an isomorphism of world sheets, while for the right-hand side we get

$$\begin{aligned}
 \gamma^{2-2\ell} P_{S_\beta, Y|_\beta}^{\text{vac}} \circ \aleph_Y \circ \text{Cor}_Y^A &= \gamma^{2-2\ell} \aleph_Y \circ P_{S_\beta, Y|_\beta}^{\text{vac}, A} \circ \text{Cor}_Y^A \\
 &= \gamma^{2-2\ell} \Lambda_A^{-1} \aleph_Y \circ E_{S_\beta, Y|_\beta}^{\text{vac}, A} \circ \text{Cor}_{\text{fl}_{S_\beta}(Y|_\beta)}^A \\
 &= \gamma^{2-2\ell} \dim(A)^{-1} E_{S_\beta, Y|_\beta}^{\text{vac}} \circ \aleph_{\text{fl}_{S_\beta}(Y|_\beta)} \circ B\ell^A(q) \\
 &\quad \circ \text{Cor}_{D \sqcup X_{B(\ell)}}^A \\
 &= \gamma^{2-2\ell} \dim(A)^{-1} E_{S_\beta, Y|_\beta}^{\text{vac}} \circ B\ell(q) \circ \aleph_{D \sqcup X_{B(\ell)}} \\
 &\quad \circ \text{Cor}_{D \sqcup X_{B(\ell)}}^A. \tag{5.49}
 \end{aligned}$$

These equalities are obtained by using (4.12), (4.21) and the fact that, as follows from evaluating (4.26) for the solution $S(\mathcal{C}, A)$, $\Lambda_A = \dim(A)$. Using further that, according to Lemma 4.4, $E_{S_\beta, Y|_\beta}^{\text{vac}}$ is injective, and that since $q = (0, f)$ is an isomorphism, so is $B\ell(q)$, we can conclude that

$$\Lambda_S^{-1} \text{Cor}_{D \sqcup X_{B(\ell)}} = \gamma^{2-2\ell} \dim(A)^{-1} \aleph_{D \sqcup X_{B(\ell)}} \circ \text{Cor}_{D \sqcup X_{B(\ell)}}^A. \tag{5.50}$$

Now $\text{Cor}_D = \gamma^2 \text{Cor}_D^A = \gamma^2 \dim(A) \text{tft}_{\mathcal{C}}(B^3)$ so that, using also that Cor and Cor^A are monoidal,

$$\Lambda_S^{-1} \gamma^2 \dim(A) \text{tft}_{\mathcal{C}}(B^3) \otimes \text{Cor}_{X_{B(\ell)}} = \gamma^{2-2\ell} \text{tft}_{\mathcal{C}}(B^3) \otimes (\aleph_{X_{B(\ell)}} \circ \text{Cor}_{X_{B(\ell)}}^A). \tag{5.51}$$

Since $\text{tft}_{\mathcal{C}}(B^3) \neq 0$ and $\chi(X_{B(\ell)}) = 2 - \ell$, we can finally write

$$\text{Cor}_{X_{B(\ell)}} = \frac{\Lambda_S}{\gamma^4 \dim(A)} \gamma^{2\chi(X_{B(\ell)})} \aleph_{X_{B(\ell)}} \circ \text{Cor}_{X_{B(\ell)}}^A. \tag{5.52}$$

In order to establish (5.37) it remains to be shown that

$$\Lambda_S = \gamma^4 \dim(A). \tag{5.53}$$

This will be done below; for the moment we keep $\mu := \Lambda_S / (\gamma^4 \dim(A))$ as a parameter.

- X_{oo} : To make the calculation below more transparent, we introduce the notations $X_{io} = X_{oi} = X_{Bp}$ and $X_{ii} = X_{B(2)}$, by which the symbols “ i ” and “ o ” indicate the in-going and out-going closed state boundaries on the sphere. Consider the world sheet $X_{oo} \sqcup X_{ii} \sqcup X_{oo}$. There are

morphisms

$$\begin{aligned} l_1 : X_{oo} \sqcup X_{ii} &\rightarrow X_{oi}, & l_2 : X_{oi} \sqcup X_{oo} &\rightarrow X_{oo}, \\ r_1 : X_{ii} \sqcup X_{oo} &\rightarrow X_{io}, & r_2 : X_{oo} \sqcup X_{io} &\rightarrow X_{oo} \end{aligned} \quad (5.54)$$

such that on $X_{oo} \sqcup X_{ii} \sqcup X_{oo}$ one has

$$l_2 \circ (l_1 \sqcup \text{id}_{X_{oo}}) = r_2 \circ (\text{id}_{X_{oo}} \sqcup r_1). \quad (5.55)$$

We can then write

$$\text{Cor}_{X_{oo}} = \text{Bl}(l_2) \circ (\text{Cor}_{X_{oi}} \otimes \text{Cor}_{X_{oo}}). \quad (5.56)$$

For X_{oi} we have already established (5.37), so that

$$\begin{aligned} \text{Cor}_{X_{oi}} &= \aleph_{X_{oi}} \circ \text{Cor}_{X_{oi}}^A = \aleph_{X_{oi}} \circ \text{Bl}^A(l_1) \circ (\text{Cor}_{X_{oo}}^A \otimes \text{Cor}_{X_{ii}}^A) \\ &= \text{Bl}(l_1) \circ \aleph_{X_{oo} \sqcup X_{ii}} \circ (\text{Cor}_{X_{oo}}^A \otimes \text{Cor}_{X_{ii}}^A) \\ &= \text{Bl}(l_1) \circ ((\aleph_{X_{oo}} \circ \text{Cor}_{X_{oo}}^A) \otimes (\aleph_{X_{ii}} \circ \text{Cor}_{X_{ii}}^A)) \\ &= \text{Bl}(l_1) \circ ((\aleph_{X_{oo}} \circ \text{Cor}_{X_{oo}}^A) \otimes (\mu^{-1} \text{Cor}_{X_{ii}})). \end{aligned} \quad (5.57)$$

Substituting this result into the right-hand side of (5.56) gives

$$\begin{aligned} \text{Cor}_{X_{oo}} &= \mu^{-1} \text{Bl}(l_2) \circ (\text{Bl}(l_1) \otimes \text{id}_{\text{Bl}(X_{oo})}) \\ &\quad \circ ((\aleph_{X_{oo}} \circ \text{Cor}_{X_{oo}}^A) \otimes \text{Cor}_{X_{ii}} \otimes \text{Cor}_{X_{oo}}). \end{aligned} \quad (5.58)$$

At this point we can use the defining condition (5.55) for the morphisms $l_{1,2}$ and $r_{1,2}$ to obtain

$$\begin{aligned} \text{Bl}(l_2) \circ (\text{Bl}(l_1) \otimes \text{id}_{\text{Bl}(X_{oo})}) &= \text{Bl}(l_2 \circ (l_1 \sqcup \text{id}_{X_{oo}})) \\ &= \text{Bl}(r_2 \circ (\text{id}_{X_{oo}} \sqcup r_1)) \\ &= \text{Bl}(r_2) \circ (\text{id}_{\text{Bl}(X_{oo})} \otimes \text{Bl}(r_1)). \end{aligned} \quad (5.59)$$

Substituting this into (5.58) yields

$$\begin{aligned} \text{Cor}_{X_{oo}} &= \mu^{-1} \text{Bl}(r_2) \circ (\text{id}_{\text{Bl}(X_{oo})} \otimes \text{Bl}(r_1)) \\ &\quad \circ ((\aleph_{X_{oo}} \circ \text{Cor}_{X_{oo}}^A) \otimes \text{Cor}_{X_{ii}} \otimes \text{Cor}_{X_{oo}}) \\ &= \mu^{-1} \text{Bl}(r_2) \circ ((\aleph_{X_{oo}} \circ \text{Cor}_{X_{oo}}^A) \otimes (\text{Bl}(r_1) \circ \text{Cor}_{X_{ii} \sqcup X_{oo}})) \\ &= \mu^{-1} \text{Bl}(r_2) \circ ((\aleph_{X_{oo}} \circ \text{Cor}_{X_{oo}}^A) \otimes \text{Cor}_{X_{io}}) \\ &= \mu^{-1} \text{Bl}(r_2) \circ ((\aleph_{X_{oo}} \circ \text{Cor}_{X_{oo}}^A) \otimes (\aleph_{X_{io}} \circ \text{Cor}_{X_{io}}^A)) \\ &= \mu^{-1} \text{Bl}(r_2) \circ \aleph_{X_{oo} \sqcup X_{io}} \circ \text{Cor}_{X_{oo} \sqcup X_{io}}^A \\ &= \mu^{-1} \aleph_{X_{oo}} \circ \text{Bl}^A(r_2) \circ \text{Cor}_{X_{oo} \sqcup X_{io}}^A, \end{aligned} \quad (5.60)$$

so that altogether

$$\text{Cor}_{X_{oo}} = \mu^{-1} \aleph_{X_{oo}} \circ \text{Cor}_{X_{oo}}^A. \quad (5.61)$$

Consider now a world sheet Y which is a disk with one in-going closed state boundary,

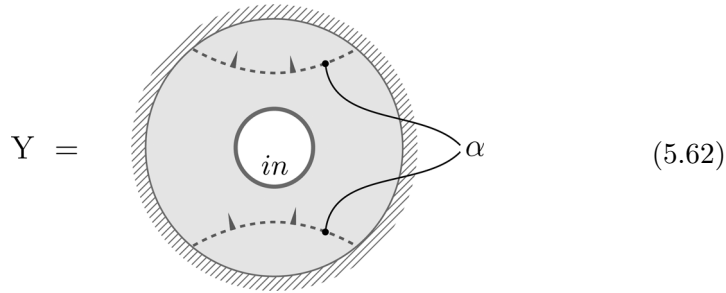

The cutting α shows that there is a morphism $\varpi: X_\eta \sqcup X_{Bb} \sqcup X_\varepsilon \rightarrow Y$, and hence by Lemma 3.16 we see that $Cor_Y = \aleph_Y \circ Cor_Y^A$. Next consider a world sheet X in the form of an annulus with cuttings α and β as follows:

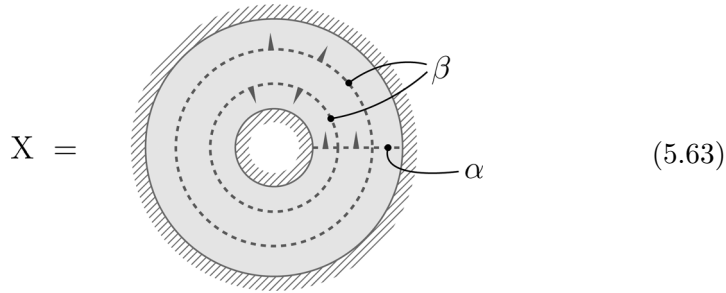

The cutting α shows that there is a morphism $\varpi: X_p \rightarrow X$, so that again by Lemma 3.16 we know that

$$Cor_X = \aleph_X \circ Cor_X^A. \tag{5.64}$$

Resulting from the cutting β there exists a morphism $q: Y \sqcup X_{oo} \sqcup Y \rightarrow X$. Applying this to rewrite Cor_X and invoking (5.61) results in

$$\begin{aligned} Cor_X &= Bl(q) \circ (Cor_Y \otimes Cor_{X_{oo}} \otimes Cor_Y) \\ &= \mu^{-1} Bl(q) \circ (\aleph_Y \otimes_{\mathbb{C}} \aleph_{X_{oo}} \otimes_{\mathbb{C}} \aleph_Y) \circ (Cor_Y^A \otimes Cor_{X_{oo}}^A \otimes Cor_Y^A) \\ &= \mu^{-1} \aleph_X \circ Bl(q) \circ Cor_{Y \sqcup X_{oo} \sqcup Y}^A = \mu^{-1} \aleph_X \circ Cor_X^A. \end{aligned} \tag{5.65}$$

Comparing to (5.64) and using that $Cor_X^A \neq 0$ (as is seen by explicit calculation according to the construction in Section 4.3), we conclude that indeed $\mu = 1$, as required.

The list of world sheets for which we have, by now, established (5.37) includes

$$X_\eta, X_\varepsilon, X_m, X_\Delta, X_{Bb}, X_{B(1)}, X_{B(3)}, X_{oo}. \quad (5.66)$$

Every world sheet can be obtained as a sewing of world sheets in this list, and hence by Lemma 3.16, equation (5.37) holds in fact for all world sheets. This completes the proof of Theorem 4.26.

6 CFT on world sheets with metric

Having completed the proof of the uniqueness theorem, Theorem 4.26, we now return to the issue of passing from the results for correlators on topological world sheets to CFT on conformal world sheets, where one deals with actual correlation *functions* of the locations of field insertions and of the moduli of the world sheet.

6.1 Conformal world sheets and conformal blocks

The basic picture is that the construction of a rational CFT, or more specifically, of a consistent set of correlation functions, proceeds in two steps. The first is complex-analytic and consists of evaluating the restrictions imposed by the chiral symmetries of the theory, which include in particular the Virasoro algebra. The second step then consists of imposing the nonchiral consistency requirements. This step, to which we refer as *solving the sewing constraints*, has been the subject of Sections 3–5. As we have seen, it can be discussed in a purely algebraic and combinatoric framework, without reference to the complex-analytic considerations, and in particular we need to consider the CFT only on topological world sheets.

The correlators are elements of suitable vector spaces of conformal blocks. In the combinatoric setting, a space of conformal blocks is just an abstract finite-dimensional complex vector space. In contrast, for CFT on conformal world sheets each space of conformal blocks is given more concretely as the fibre of a vector bundle, equipped with a projectively flat connection, over a moduli space of decorated complex curves (the complex doubles of the world sheets). This bundle, in turn, is determined through the chiral symmetry algebra \mathcal{V} and the \mathcal{V} -representations that are carried by the field insertions. The chiral symmetries can be formalized in the structure of a conformal vertex algebra \mathcal{V} . Then the space of conformal blocks for a correlator with field insertions carrying \mathcal{V} -representations $\lambda_1, \lambda_2, \dots, \lambda_m$ can be described as a certain \mathcal{V} -invariant subspace in the space of multilinear maps from

$\lambda_1 \times \lambda_2 \times \cdots \times \lambda_m$ to \mathbb{C} . (To describe how these vector spaces fit together to form the total space of a vector bundle of the relevant moduli space one must study sheaves of conformal vertex algebras [5].)

For a rational CFT, the representation category $\mathcal{R}ep(\mathcal{V})$ is ribbon [45] and even modular [46]. Motivated by the path-integral formulation in the case of Chern–Simons theories [47, 48] one identifies the spaces of states that the 3D TFT associated to the modular tensor category $\mathcal{R}ep(\mathcal{V})$ assigns to surfaces with fibres of the bundles of conformal blocks. The 3D TFT should then encode the behaviour of conformal blocks under sewing as well as the action of the mapping class group. (This is known to be true for genus 0 and genus 1 if \mathcal{V} obeys the conditions of Theorem 2.1 in [46], but for higher genus it still remains open.) Note that in the second step, i.e., for solving the sewing constraints, the only input needed is the category $\mathcal{R}ep(\mathcal{V})$ as a ribbon category.

Our aim is now to analyse CFT on conformal world sheets with the help of categories, functors between them and natural transformations that are analogous to those that appeared in the combinatorial setting above. To begin with, it does not suffice to endow the topological world sheet with a conformal structure, but we must also specify a metric in the conformal equivalence class. Thus an (oriented open/closed) *world sheet with metric*, or *world sheet*, for short, is a surface of the type shown in figure 1 (p. 1293), except that the specification of an orientation must be supplemented by the specification of a metric. We denote world sheets with metric by X^c , where X is the underlying topological world sheet. When discussing CFT on world sheets with metric we can draw from descriptions used in string theory (see e.g., [7, 18, 49]), from the study of sewing constraints [20, 50, 51] and from aspects of the axiomatics of [34, 52]. (For recent treatments of open/closed CFT from similar points of view see e.g., [53–55].) What we are interested in here could more precisely be referred to as compact oriented open/closed CFT; the qualifier “compact” refers to a discreteness condition on the relevant spaces of states.

6.2 Consistency conditions for correlation functions

We regard world sheets X^c as the objects of a category $\mathcal{W}Sh^c$ and, analogously as in the case of the category $\mathcal{W}Sh$, as morphisms of $\mathcal{W}Sh^c$ we allow for both isomorphisms of world sheets and for sewings, and for combinations of the two. An isomorphism between world sheets X^c and Y^c is an orientation preserving isometry f from X^c to Y^c that is compatible with the parametrization of the state boundaries. A sewing \mathcal{S} is analogous to a

sewing in \mathcal{WSh} , but only such sewings are allowed which lead to a smooth metric on the sewed world sheet. One can also define a tensor product on \mathcal{WSh}^c by taking disjoint unions; the tensor unit is the empty set.

The defining data of a (compact, oriented) open/closed CFT are the *boundary* and *bulk state spaces*, i.e., spaces of “open” and “closed” states, and a collection Cor^c of *correlation functions* — analogues of the corresponding combinatorial data that enter the definition of the block functor $B\ell$. The state spaces are complex vector spaces which come with a hermitian inner product and are discretely \mathbb{R} -graded by the eigenvalues of the dilation operator; we denote them by H_{op} and H_{cl} , respectively, and their graded duals by H_{op}^\vee and H_{cl}^\vee . Given a world sheet $X^c \in \text{Obj}(\mathcal{WSh}^c)$, we denote by $F(X^c)$ the vector space of multilinear functions

$$f : H_{\text{op}}^{|\text{o-in}|} \times (H_{\text{op}}^\vee)^{|\text{o-out}|} \times H_{\text{cl}}^{|\text{c-in}|} \times (H_{\text{cl}}^\vee)^{|\text{c-out}|} \longrightarrow \mathbb{C} \quad (6.1)$$

subject to a suitable boundedness condition; note that $F(X^c)$ does not depend on the metric. A collection of correlation functions assigns to every $X^c \in \text{Obj}(\mathcal{WSh}^c)$ a multilinear function $Cor_{X^c}^c \in F(X^c)$, called the correlation function on the world sheet X^c . (The boundedness condition on $F(X^c)$ is imposed to ensure that $Cor_{X^c}^c$ is a bounded multilinear function on the relevant product of state spaces.) Given a sewing \mathcal{S} of X^c , we introduce the operation of *partial evaluation* $F(\mathcal{S})$ on $F(X^c)$; it consists of evaluating, for each pair in \mathcal{S} , the corresponding pair H_{op} and H_{op}^\vee , respectively, H_{cl} and H_{cl}^\vee , for the in- and out-going state boundaries of that pair in \mathcal{S} .

To define an open/closed CFT, we now demand that the collection Cor^c of correlation functions possesses the following properties:

- C1 – *Sewing*: $Cor_{\mathcal{S}(X^c)}^c = F(\mathcal{S})(Cor_{X^c}^c)$ for every sewing \mathcal{S} of a world sheet X^c .
- C2 – *Isomorphism*: If two world sheets X^c and Y^c are isomorphic, then $Cor_{X^c}^c = Cor_{Y^c}^c$.
- C3 – *Disjoint union*: $Cor_{X^c \sqcup Y^c}^c = Cor_{X^c}^c \cdot Cor_{Y^c}^c$.
- C4 – *Weyl transformations*: If X^c and $X^{c'}$ have the same underlying topological world sheet X and their metrics g and g' are conformally related, i.e., obey $g'_p = e^{\sigma(p)}g_p$ with some smooth function $\sigma : X \rightarrow \mathbb{R}$, then $Cor_{X^c}^c = e^{cS[\sigma]}Cor_{X^{c'}}^c$, where c is the conformal central charge and $S[\sigma]$ is the Liouville action (see [56, 57] for details).

We will now argue that the conditions C1–C3 amount to requiring Cor^c to be a monoidal natural transformation between suitable functors, analogously

as imposing Cor to be a monoidal natural transformation yields a solution to the sewing constraints for correlators on topological world sheets. We denote by $\mathcal{M}lin(H_{op}, H_{cl})$ the category whose objects are spaces of multilinear maps $H_{op}^m \times (H_{op}^\vee)^n \times H_{cl}^r \times (H_{cl}^\vee)^s \rightarrow \mathbb{C}$ for $m, n, r, s \in \mathbb{Z}_{\geq 0}$ and whose morphisms are suitable linear maps between these spaces, which include in particular the partial evaluations.¹¹ Via the product of multilinear functions (i.e., setting $(f \cdot g)(x, y) := f(x)g(y)$), one turns $\mathcal{M}lin(H_{op}, H_{cl})$ into a symmetric strict monoidal category. The tensor unit is given by the multilinear maps from zero copies of the spaces $H_{op}, \dots, H_{cl}^\vee$ to \mathbb{C} , which we identify with the space M_0 of linear maps from \mathbb{C} to \mathbb{C} .

The assignment F defined through formula (6.1) for world sheets and through partial evaluation for sewings becomes a strict monoidal functor from $\mathcal{W}Sh^c$ to $\mathcal{M}lin(H_{op}, H_{cl})$ by complementing it to act as

$$X^c \mapsto F(X^c), \quad \mathcal{S} \mapsto F(\mathcal{S}) \quad \text{and} \quad f \mapsto F(f) := \text{id}_{F(X^c)} \tag{6.2}$$

for world sheets, sewings, and isomorphisms $f: X^c \rightarrow Y^c$ of world sheets, respectively. Note that if there exists an isomorphism $f: X^c \rightarrow Y^c$, then $F(X^c) = F(Y^c)$.¹² We also need a “trivial” monoidal functor

$$One^c : \mathcal{W}Sh^c \rightarrow \mathcal{M}lin(H_{op}, H_{cl}) \tag{6.3}$$

analogous to (3.22); we set $One^c(X) := \text{id}_{\mathbb{C}} \in M_0$ and $One^c(\mathcal{S}) := \text{id}_{M_0}$ as well as $One^c(f) := \text{id}_{M_0}$.

The conditions C1–C3 are equivalent to the statement that Cor^c is a monoidal natural transformation from One^c to F . Indeed, by definition, a natural transformation furnishes a family $\{Cor_{X^c}^c\}$ of linear maps

$$Cor_{X^c}^c : One^c(X^c) \rightarrow F(X^c) \tag{6.4}$$

¹¹For characterizing the allowed maps one must also address some convergence issues. We refrain from going into any details in the present discussion.

¹²In order for F to be monoidal, for nonconnected world sheets we must define $F(X^c)$ to be the tensor product (in the category $\mathcal{M}lin(H_{op}, H_{cl})$) $F(X_1^c) \otimes \dots \otimes F(X_m^c)$, with X_i the connected components of X . In contrast, were we to take e.g., $F(X_1^c \sqcup X_2^c)$ to consist of all multilinear maps as well, then $F(X_1^c) \otimes F(X_2^c)$ would typically only be a subspace of $F(X_1^c \sqcup X_2^c)$, e.g., not every bilinear function from $H_{op} \times H_{op}$ to \mathbb{C} can be written as a finite sum of products $f \cdot g$ of linear functions f and g from H_{op} to \mathbb{C} .

for $X^c \in \text{Obj}(\mathcal{WSh}^c)$, in a way consistent with composition. Thus for any sewing $\mathcal{S}: X^c \rightarrow \mathcal{S}(X^c)$ and any isomorphism $f: X^c \rightarrow Y^c$ the diagrams

$$\begin{array}{ccc}
 \text{One}^c(X^c) & \xrightarrow{\text{One}^c(\mathcal{S})} & \text{One}^c(\mathcal{S}(X^c)) \\
 \downarrow \text{Cor}_{X^c}^c & & \downarrow \text{Cor}_{\mathcal{S}(X^c)}^c \\
 F(X^c) & \xrightarrow{F(\mathcal{S})} & F(\mathcal{S}(X^c))
 \end{array}
 \quad \text{and} \quad
 \begin{array}{ccc}
 \text{One}^c(X^c) & \xrightarrow{\text{One}^c(f)} & \text{One}^c(Y^c) \\
 \downarrow \text{Cor}_{X^c}^c & & \downarrow \text{Cor}_{Y^c}^c \\
 F(X^c) & \xrightarrow{F(f)} & F(Y^c)
 \end{array}
 \tag{6.5}$$

commute. The first diagram precisely amounts to condition C1, and the second to C2. Finally, that Cor^c is monoidal is, by definition of the tensor product in the category $\mathcal{Mlin}(H_{\text{op}}, H_{\text{cl}})$, nothing but the statement of C3. Thus it is indeed justified to interpret the linear maps (6.4) as the correlation functions.

As outlined in Section 6.1, to find solutions to C1–C4 it is useful to first specify a minimal symmetry one desires the final theory to possess, and then analyse how that symmetry constrains the possible solutions to C1–C4. This approach effectively amounts to selecting a subspace $\text{Bl}^c(X^c) \subset F(X^c)$ for each $X^c \in \text{Obj}(\mathcal{WSh}^c)$. Afterwards one tries to find a consistent set $\text{Cor}_{X^c}^c$ of correlation functions in the restricted spaces $\text{Bl}^c(X^c)$. For suitable choices of symmetry the spaces $\text{Bl}^c(X^c)$ are finite-dimensional, so that passing from F to Bl^c is a significant simplification.

To proceed, one would now like to employ the natural transformation Cor from One to Bl discussed in Sections 3–5 to obtain also a natural transformation Cor^c from One^c to Bl^c which, as just seen, is the same as giving a solution to C1–C3. Condition C4 is then taken care of automatically by the fact that an element in $\text{Bl}(X^c)$ corresponds to an appropriate section in the bundle over the moduli space of world sheets in \mathcal{WSh}^c of the same topological type as X^c , whose fibres are given by $\text{Bl}^c(\cdot)$. How this will work out exactly is, however, still unclear, and thus it seems fair to say that a precise and detailed understanding of the relation between the complex-analytic and the combinatorial part of the construction of RCFT correlation functions is still lacking.

Acknowledgments

We thank Terry Gannon, Liang Kong, Hendryk Pfeiffer, Karl-Henning Rehren and Gerard Watts for useful discussions, and Natalia Potylitsina-Kube for help with the illustrations. J.Fj. received partial support from the EU RTN ‘‘Quantum Spaces-Noncommutative Geometry,’’ J.Fu. from

VR under project no. 621–2003–2385, I.R. from the EPSRC First Grant EP/E005047/1 and the PPARC rolling grant PP/C507145/1, and C.S. from the Collaborative Research Centre 676 “Particles, Strings and the Early Universe — the Structure of Matter and Space-Time.”

References

- [1] J. Fuchs, I. Runkel and C. Schweigert, *TFT construction of RCFT correlators I: partition functions*, Nucl. Phys. B **646** (2002), 353 [arxiv: hep-th/0204148].
- [2] J. Fjelstad, J. Fuchs, I. Runkel and C. Schweigert, *TFT construction of RCFT correlators V: Proof of modular invariance and factorisation*, Theory Appl. Categ. **16** (2006), 342 [arxiv:hep-th/0503194].
- [3] Y.-Z. Huang, *Two-dimensional conformal geometry and vertex operator algebras*, Birkhäuser, Boston, 1997.
- [4] B. Bakalov and A.A. Kirillov, *Lectures on tensor categories and modular functors*, American Mathematical Society, Providence, 2000.
- [5] E. Frenkel and D. Ben-Zvi, *Vertex algebras and algebraic curves*, second edition, Mathematical Surveys and Monographs Series, **88**, American Mathematical Society, Providence, 2004.
- [6] V. Alessandrini, *A general approach to dual multiloop diagrams*, Nuovo Cimento 2A (1971), 321.
- [7] S.K. Blau, M. Clements, S. Della Pietra, S. Carlip and V. Della Pietra, *The string amplitude on surfaces with boundaries and crosscaps*, Nucl. Phys. B **301** (1988), 285.
- [8] M. Bianchi and A. Sagnotti, *Open strings and the relative modular group*, Phys. Lett. B **231** (1989), 389.
- [9] J. Fuchs and C. Schweigert, *Branes: from free fields to general backgrounds*, Nucl. Phys. B **530** (1998), 99 [arxiv:hep-th/9712257].
- [10] G. Felder, J. Fröhlich, J. Fuchs and C. Schweigert, *Correlation functions and boundary conditions in RCFT and three-dimensional topology*, Compos. Math. **131** (2002), 189 [arxiv:hep-th/9912239].
- [11] J. Fuchs, I. Runkel and C. Schweigert, *TFT construction of RCFT correlators IV: structure constants and correlation functions*, Nucl. Phys. B **715** (2005), 539 [arxiv:hep-th/0412290].
- [12] J. Fröhlich, J. Fuchs, I. Runkel and C. Schweigert, *Duality and defects in rational conformal field theory*, Nucl. Phys. B **763** (2007), 354 [arxiv:hep-th/0607247].
- [13] J. Fuchs, I. Runkel and C. Schweigert, *TFT construction of RCFT correlators II: unoriented surfaces*, Nucl. Phys. B **678** (2004), 511 [arxiv:hep-th/0306164].

- [14] C. Schweigert, J. Fuchs and I. Runkel, *Categorification and correlation functions in conformal field theory*, Proceedings of the ICM 2006, M. Sanz-Solé, J. Soria, J.L. Varona and J. Verdera, Eds., European Mathematical Society, 443 (2006) [arXiv:math.CT/0602079].
- [15] V.G. Turaev, *Quantum invariants of knots and 3-manifolds*, de Gruyter, New York, 1994.
- [16] C. Kassel, M. Rosso and V. Turaev, *Quantum groups and knot invariants*, Soc. Math. de France, Paris, 1997.
- [17] R. Longo and K.-H. Rehren, *Local fields in boundary conformal QFT*, Rev. Math. Phys. **16** (2004), 909 [arxiv:math-ph/0405067].
- [18] C. Vafa, *Conformal theories and punctured surfaces*, Phys. Lett. B **199** (1987), 195.
- [19] H. Sonoda, *Sewing conformal field theories*, Nucl. Phys. B **311** (1988), 401.
- [20] D.C. Lewellen, *Sewing constraints for conformal field theories on surfaces with boundaries*, Nucl. Phys. B **372** (1992), 654.
- [21] C.I. Lazaroiu, *On the structure of open-closed topological field theory in two dimensions*, Nucl. Phys. B **603** (2001), 497 [arxiv:hep-th/0010269].
- [22] G. Moore, *Some comments on branes, G-flux, and K-theory*, Int. J. Mod. Phys. A **16** (2001), 936 [arxiv:hep-th/0012007].
- [23] G.B. Segal, *Topological structures in string theory*, Philos. Trans. R. Soc. Lond. **359** (2001), 1389.
- [24] A.D. Lauda and H. Pfeiffer, *Open-closed strings: two-dimensional extended TQFTs and Frobenius algebras*, Topology Applic. **155** (2008), 623 [arxiv:math.AT/0510664].
- [25] G. Moore and G. Segal, *D-branes and K-theory in 2D topological field theory*, preprint, arxiv:hep-th/0609042.
- [26] U. Tillmann, *S-structures for k-linear categories and the definition of a modular functor*, J. London Math. Soc. **58** (1998), 208 [arxiv:math.GT/9802089].
- [27] N.A. Baas, R.L. Cohen and A. Ramírez, *The topology of the category of open and closed strings*, Contemp. Math. **407** (2006), 11 [arxiv:math.AT/0411080].
- [28] N.Yu. Reshetikhin and V.G. Turaev, *Invariants of 3-manifolds via link polynomials and quantum groups*, Invent. math. **103** (1991), 547.
- [29] C. Kassel, *Quantum groups*, Springer Verlag, New York, 1995.
- [30] A. Joyal and R. Street, *Braided tensor categories*, Adv. Math. **102** (1993), 20.
- [31] J. Fröhlich, J. Fuchs, I. Runkel and C. Schweigert, *Correspondences of ribbon categories*, Adv. Math. **199** (2006), 192 [arxiv:math.CT/0309465].

- [32] M. Müger, *From subfactors to categories and topology II. The quantum double of tensor categories and subfactors*, J. Pure Appl. Algebra **180** (2003), 159 [arxiv:math.CT/0111205].
- [33] S. Stolz and P. Teichner, *What is an elliptic object?* in ‘Topology, Geometry and Quantum Field Theory’, Ed. U. Tillmann, London Math. Soc. Lecture Note Series, **308**, Cambridge University Press, Cambridge 2004, 247.
- [34] G.B. Segal, *Two-dimensional conformal field theories and modular functors*, in ‘IXth International Congress on Mathematical Physics’, Eds. B. Simon, A. Truman and I.M. Davis, Adam Hilger, Bristol, 1989, 22.
- [35] G. Moore and N. Seiberg, *Lectures on RCFT*, in ‘Physics, Geometry, and Topology’, Ed. H.C. Lee, Plenum Press, New York 1990, 263.
- [36] J.E. Andersen and K. Ueno, *Modular functors are determined by their genus zero data*, preprint, arxiv:math.QA/0611087.
- [37] D.C. Lewellen, *Constraints for conformal field theories on the plane: reviving the conformal bootstrap*, Nucl. Phys. B **320** (1989), 345.
- [38] G. Pradisi, A. Sagnotti and Ya.S. Stanev, *Completeness conditions for boundary operators in 2D conformal field theory*, Phys. Lett. B **381** (1996), 97 [arxiv:hep-th/9603097].
- [39] R.M. Kaufmann and R.C. Penner, *Closed/open string diagrammatics*, Nucl. Phys. B **748** (2006), 335 [arxiv:math.GT/0603485].
- [40] I. Runkel, J. Fjelstad, J. Fuchs and C. Schweigert, *Topological and conformal field theory as Frobenius algebras*, Contemp. Math. **431** (2007), 225 [arxiv:math.CT/0512076].
- [41] A.D. Lauda and H. Pfeiffer, *State sum construction of two-dimensional open-closed topological quantum field theories*, J. Knot Theory Ramif. **16** (2007), 1121 [arxiv:math.AT/0602047].
- [42] M. Auslander, I. Reiten and S.O. Smalø, *Representation theory of Artin algebras*, Cambridge University Press, Cambridge, 1995.
- [43] P. di Francesco, P. Mathieu and D. Senechal, *Conformal field theory*, Springer Verlag, New York, 1996.
- [44] P.I. Etingof, D. Nikshych and V. Ostrik, *On fusion categories*, Ann. Math. **162** (2005), 581 [arxiv:math.QA/0203060].
- [45] Y.-Z. Huang and J. Lepowsky, *Tensor products of modules for a vertex operator algebra and vertex tensor categories*, in ‘Lie Theory and Geometry’, Eds. R. Brylinski *et al.*, Birkhäuser, Boston 1994, 349 [arxiv:hep-th/9401119].
- [46] Y.-Z. Huang, *Vertex operator algebras, the Verlinde conjecture and modular tensor categories*, Proc. Natl. Acad. Sci. USA **102** (2005), 5352 [arxiv:math.QA/0412261].

- [47] E. Witten, *Quantum field theory and the Jones polynomial*, *Comm. Math. Phys.* **121** (1989), 351.
- [48] J. Fröhlich and C. King, *The Chern–Simons theory and knot polynomials*, *Comm. Math. Phys.* **126** (1989), 167.
- [49] D.H. Friedan and S.H. Shenker, *The analytic geometry of two-dimensional conformal field theory*, *Nucl. Phys. B* **281** (1987), 509.
- [50] J.L. Cardy, *Operator content of two-dimensional conformally invariant theories*, *Nucl. Phys. B* **270** (1986), 186.
- [51] J.L. Cardy and D.C. Lewellen, *Bulk and boundary operators in conformal field theory*, *Phys. Lett. B* **259** (1991), 274.
- [52] G.B. Segal, *The definition of conformal field theory*, in ‘Topology, Geometry and Quantum Field Theory’, Ed. U. Tillmann, *London Math. Soc. Lecture Note Series*, **308**, Cambridge University Press, Cambridge 2004, 421.
- [53] Y.-Z. Huang, *Riemann surfaces with boundaries and the theory of vertex operator algebras*, *Fields Inst. Commun.* **39** (2003), 109 [arxiv:math.QA/0212308].
- [54] Y.-Z. Huang and L. Kong, *Open-string vertex algebras, tensor categories and operads*, *Comm. Math. Phys.* **250** (2004), 433 [arxiv:math.QA/0308248].
- [55] P. Hu and I. Kriz, *Closed and open conformal field theories and their anomalies*, *Comm. Math. Phys.* **254** (2005), 221 [arxiv:hep-th/0401061].
- [56] K. Gawędzki, *Conformal field theory*, *Astérisque* **177–178** (1989), 95.
- [57] ———, *Lectures on conformal field theory*, in ‘Quantum Fields and Strings: A Course for Mathematicians’, Eds. P. Deligne *et al.*, American Mathematical Society, Providence 1999, 727.

