

Parameter space of quiver gauge theories

Martijn Wijnholt

Physics Department, Jadwin Hall, Princeton University,
Princeton, NJ 08544, USA

Abstract

Placing a set of branes at a Calabi–Yau singularity leads to an $\mathcal{N} = 1$ quiver gauge theory. We analyze F -term deformations of such gauge theories. A generic deformation can be obtained by making the Calabi–Yau non-commutative. We discuss non-commutative generalizations of well-known singularities such as the Del Pezzo singularities and the conifold.

We also introduce new techniques for deriving superpotentials, based on quivers with ghosts and a notion of generalized Seiberg duality. The curious gauge structure of quivers with ghosts is most naturally described using the BV formalism. Finally we suggest a new approach to Seiberg duality by adding fields and ghost-fields whose effects cancel each other.

1 Parameter space of quiver gauge theories

One of the most reliable ways to engineer a gauge theory from string theory is by placing a set of D-branes in some background geometry. If we require the gauge theory to be four-dimensional with $\mathcal{N} = 1$ supersymmetry, then up to dualities one typically has to look at D-branes filling four flat dimensions and

wrapped on (possibly collapsed) cycles in a Calabi–Yau threefold. Embedding a gauge theory into string theory is relevant for at least two of the main threads of research: it generates examples of the ADS/CFT correspondence, and it is a first step towards bottom–up string phenomenology. Apart from this, the gauge theory is closely tied to the Calabi–Yau geometry, and there are amusing relations with modern areas of mathematics.

In this article we will focus on the gauge theory one obtains from a set of N D3-branes located at a Calabi–Yau threefold singularity in type IIB string theory. The theories one obtains this way are of quiver type, and for $N > 1$ are believed to flow to interesting interacting conformal field theories. For applications to either ADS/CFT or phenomenology, one would like to understand the possible deformations of the gauge theory.

By ADS/CFT intuition it is tempting to believe that small deformations of the gauge theory can still be realized after embedding in string theory. This is particularly clear when the theory is conformal and the deformations are marginal. Nevertheless, if one examines the quiver gauge theory, the number of deformations is larger than the number of conventional geometric deformations of the local Calabi–Yau geometry. So the puzzle is how to identify the full parameter space of the quiver in string theory.

We will examine a number of well-known Calabi–Yau singularities and account for all the marginal deformations that can be understood as F -term data (i.e., superpotential deformations). Some of these deformations can be understood as conventional complex structure deformations of the Calabi–Yau, and were previously investigated by the author in [2]. Here we find that all the remaining deformations of these quiver theories can be understood as non-commutative deformations of the Calabi–Yau.¹ We emphasize that the four-dimensional gauge theory living on the branes is a conventional commutative gauge theory.

As in our previous work, in order to uncover the map between the gauge theory parameter space and the Calabi–Yau parameter space, we will need to make use of the general technique of exceptional collections. Other approaches that the author is aware of are not flexible enough to deal with deformations. Another complication is that in the presence of non-commutative deformations, the moduli space of the quiver theory for a single D3-brane is not the Calabi–Yau itself.

Another topic we address here is the effect of certain braiding operations on the quiver diagram. It is known [4] that a subset of such operations

¹In particular we find the missing deformations of [3].

can be understood as Seiberg duality on the gauge theory. However there are more general operations (generalized Seiberg dualities) which do not have an immediate gauge theory interpretation. Building on some unpublished work with Cachazo, Katz and Vafa [5] we discuss how to deal with the resulting quivers. The more general quivers one obtains this way can be thought of as quivers with ghosts, and this leads to a consistent way of manipulating them. Our point of view here is not that these manipulations can be carried out in field theory — indeed we do not know how to associate a sensible gauge theory to a quiver with ghosts — however, it is that these manipulations make sense at the level of F -terms and can be used as a technique for computing topological data such as superpotentials in physical quiver gauge theories.

Relations between quivers and non-commutative Calabi–Yau spaces have previously been pursued in the series of papers [6–9]. Other aspects of exceptional collections have recently been explored in [10–12]. A word on notation: when we write superpotentials, the overall trace will be implicit.

2 Large volume construction of quiver theories

2.1 Topological amplitudes

We are interested in the low energy gauge theory for a set of branes placed at a Calabi–Yau singularity in type IIb string theory. It is generally believed that this gauge theory can be described in terms of a basis of “fractional branes” which depend on the singularity. There is no general proof of this statement because the conformal field theory is typically not under complete control, but many cross-checks have been made and the fractional brane picture holds up rather well.

So we assume that there is a set of boundary states $\{F_1, \dots, F_n\}$ “localized” at the singularity, with the following properties:

- the RR charge vectors (which describe the coupling to RR fields) form a basis for the homology lattice of vanishing cycles;
- they all break the same half of the eight supercharges, i.e., they are mutually BPS;
- they are “irreducible” and other possible branes can be expressed as bound states of the fractional branes.

For a discussion of the last item, see [13].

Suppose then we want to describe the world volume theory of some set of branes. For convenience we will take the case of a D3-brane, which corresponds to some boundary state F_p on the Calabi–Yau, and let us denote the RR charge vector by “ch.” Then we can first decompose F_p into the F_i at the level of homology:

$$\text{ch}(F_p) = \sum_{i=1}^n n_i \text{ch}(F_i). \quad (2.1)$$

The massless fields arising from open string modes are easy to recognize. From open strings stretching between the $|n_i|$ fractional branes of type i one expects a vector multiplet in the adjoint of $U(|n_i|)$. Also, for each “intersection” of two fractional branes one expects a chiral multiplet. By “intersection” we mean the intersection of the vanishing cycles associated with a fractional brane according to its charge vector. Even in our case where we only have even cycles, such intersections should be counted with a sign (as is also required in order to be consistent with mirror symmetry). Depending on this sign, one gets a chiral multiplet in the anti-fundamental of F_i and the fundamental of F_j or reversely.

This minimal amount of data determines the massless field content and therefore a large part of the low energy theory. This data, as is well known, can be summarized in a quiver diagram. To fix the parameters in this low energy gauge theory requires one to compute a finite set of string amplitudes and compare with the corresponding amplitudes of the effective gauge theory. Thus our main concern is to find a good basis of fractional branes. Unfortunately except for the case of orbifolds of flat space (i.e., free field theory) one is unable to do that.

There is a trick however if we restrict ourself to a topological subsector of the full open string theory. In our setting this is the (open string) B-model. The matter part of a string vertex operator is composed of a four-dimensional part and an internal six-dimensional part that lives on the Calabi–Yau. A certain class of string amplitudes can be computed in the topologically twisted theory. From the gauge theory point of view, this is the set of amplitudes that can be calculated just from the F -terms without using any information from the D-terms.

The beauty of this class of amplitudes is that they do not depend on the (complexified) Kähler parameters of the Calabi–Yau, since those would only affect the D-terms. From the point of view of the topological BRST operator, Kähler deformations are exact. Therefore we can change the Kähler parameters and go to a point in moduli space where we do know the conformal field theory. Such a point is given by the large volume limit, where

we can use the non-linear sigma model. In this limit, one can describe the fractional branes as certain exceptional collections of sheaves localized on the collapsing cycles.²

In the $n\sigma m$ description, the massless open string modes are counted by certain cohomology groups, the global Ext groups. Thus, given two sheaves F_i, F_j localized on collapsing cycles, we should first extend the sheaves to i_*F_i, i_*F_j on the Calabi–Yau threefold (where i is the embedding of the collapsing cycles into the Calabi–Yau threefold), and then compute³

$$\mathrm{Ext}^p(i_*F_i, i_*F_j). \quad (2.2)$$

The grade p is called the ghost number of a topological vertex operator (it is however in the matter sector in the full ten-dimensional string theory, which uses a different ghost number symmetry).

As argued in [13], the correct large volume description of fractional branes is typically not just a set of sheaves. We should also do some spectral flow on the boundary conditions, using the $U(1)$ generator of the worldsheet $N = 2$ algebra. Unless one takes this into account, one finds that the ghost number of a vertex operator (which is just the charge under this $U(1)$) may not have the same value in the large volume limit. In order to account for this, one embeds the sheaves in the derived category, where the spectral flow we need to repair the ghost number is interpreted as a shift in the position in the complex. Changing the vertex operators by spectral flow is strictly not needed in that the correlation functions in our context are only changed by a trivial factor, but it is nevertheless useful to keep track of it. Spectral flow will be indicated with the conventional derived category notation, e.g., $F[k]$ denotes F with k units of spectral flow applied. The ghost number of

$$V \in \mathrm{Ext}^p(E[q], F[r]) \quad (2.3)$$

is $N_{gh} = p - q + r$. In the following we will assume that the appropriate shifts have been made in (2.2).

It is a well-known fact that the usual physical vertex operators sit at ghost number one, but in principle one can have “ghosts”, i.e., BRST cohomology classes at ghost numbers different from one. The open string field theory for the B-model is of Chern–Simons type [14], and the appearance of many ghosts is quite typical if one quantizes such a theory. As we review momentarily, operators at ghost number zero are associated with symmetries

²Actually it is clear that this needs to be slightly generalized, for instance condensing some fields in a quiver obtained from a three-block exceptional collection does not give rise to another exceptional collection. We will omit such subtleties from the discussion.

³We will often drop the push-forward symbol “ i_* ” in the remainder of this section, to simplify notation.

(boundary ground ring), operators at ghost number minus one with “ghosts for ghosts” (symmetries among symmetries), etc.

We could also get vertex operators with ghost number $p > 1$. These are called the anti-fields. They have the interpretation of obstructions to the deformations, obstructions for the obstructions and so on. There is a pairing between vertex operators of ghost number p and ghost number $3 - p$ given by the disk two-point function (which evaluates to the Serre duality pairing). Given a vertex operator of ghost number $p > 1$, it is more natural for us to consider its dual under this duality pairing. For instance the dual of a ghost number $p = 2$ operator has ghost number $p = 1$, and thus it can be interpreted as a deformation. In our context this corresponds to moving the brane away from the collapsing cycle in the non-compact direction. After GSO projection, an operator of ghost number $p = 1$ gives rise to a chiral field in four dimensions, and its dual operator of ghost number $p = 2$ gives rise to the conjugate anti-chiral field. This is also familiar from heterotic model building on a Calabi–Yau [1].

Given a set of V_i vertex operators of ghost number one, with $V_i \in \text{Ext}^1(F_i, F_{i+1})$ and assuming $F_{n+1} = F_1$, we can define a disk amplitude as

$$\left\langle V_1(\infty)V_2(0)V_3(1) \int_1^{y_4} V_4 \int_{y_4}^{y_5} V_5 \cdots \int_{y_{n-1}}^{\infty} V_n \right\rangle. \quad (2.4)$$

In the low energy gauge theory we get the analogous tree level amplitude to be proportional to a certain coefficient in the superpotential, namely the coefficient of

$$\text{Tr} \int d^2\theta \Phi_1 \Phi_2 \Phi_3 \cdots \Phi_n. \quad (2.5)$$

(since we cannot use the Kähler terms and since there is no mass term in the superpotential, it is impossible to build an n -point Feynman diagram by contracting lower-point vertices). Thus the amplitudes (2.4) compute coefficients in the superpotential.

2.2 Ghost number zero operators

Now let us try to understand the role of vertex operators of ghost number different from one. Suppose again that $V_i \in \text{Ext}^1(F_i, F_{i+1})$ and consider $O \in \text{Ext}^0(F_4, F_1)$. Consider the amplitude

$$\langle V_1(\infty)V_2(0)V_3(1)O(y) \rangle. \quad (2.6)$$

Note that since $O(y)$ has ghost number zero, it should not be integrated over the boundary. Now the amplitude is independent of the position of the

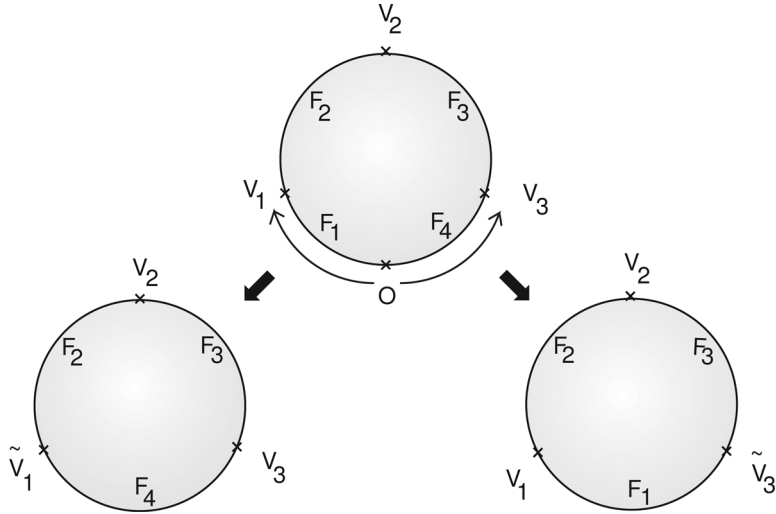

Figure 1: Ghost number zero operators can be used to relate disk amplitudes.

ghost number zero operator (since $\partial O = \{Q, b_{-1}O\}$). So we can take the limit $y \rightarrow 1$, in which case we get

$$\lim_{y \rightarrow 1} V_3(1)O(y) = -V'_3(1) \in \text{Ext}^1(F_3, F_1). \tag{2.7}$$

For chiral primaries there are no poles in the OPEs. Alternatively we can take the limit $y \rightarrow \infty$, in which case we have

$$\lim_{y \rightarrow \infty} O(y)V_1(\infty) = V'_1(\infty) \in \text{Ext}^1(F_4, F_1). \tag{2.8}$$

Therefore we find

$$\langle V_1(\infty)V_2(0)V'_3(1) \rangle + \langle V'_1(\infty)V_2(0)V_3(1) \rangle = 0. \tag{2.9}$$

In other words, the ghost number zero operators generate relations among the superpotential couplings. Such symmetries in turn guarantee the existence of flat directions. Namely the superpotential terms $\text{Tr}(\Phi_1\Phi_2\Phi'_3 + \Phi'_1\Phi_2\Phi_3)$ are invariant under

$$\delta\Phi'_1 = \Lambda\Phi_1, \quad \delta\Phi'_3 = -\Phi_3\Lambda. \tag{2.10}$$

An expectation value for Λ (which we may think of as the four-dimensional partner of O) has no interpretation in the D-brane system, it is purely a redundancy of the description. Therefore we should mod out by such symmetries. If F_1 and F_4 correspond to identical boundary conditions, this is easy to understand; in this case the transformations (2.10) just correspond to the non-abelian gauge transformations that arise when you have a stack of identical branes on top of each other. However we will see examples in which $F_1 \neq F_4$, and there is a generator in $\text{Ext}^0(F_4, F_1)$ but not in $\text{Ext}^0(F_1, F_4)$.

In that case the ghost number zero operators do not generate a reductive Lie algebra, i.e., a sum of simple and semi-simple algebras, but a parabolic algebra, and it seems impossible to gauge it and preserve CPT.

Even though we seem to be unable to associate a physical quiver when we have parabolic symmetries, it will be convenient to associate quiver diagrams to such exceptional collections and manipulate them. Any such collection should contain all the information about F -terms. For each parabolic generator we can introduce a ghost field Λ which is a chiral field except with the opposite statistics. Because of the unusual statistics the corresponding arrow in the quiver diagram should be reversed. Similar remarks apply to operators of ghost number $p < 0$. These correspond to ghosts-for-ghosts, etc. Of course cohomology classes of topological ghost number p do not necessarily correspond to cohomology classes of physical ghost number p , since the ghost number grading in the ten-dimensional string theory is different. For instance cohomology classes of ghost number zero that live in an adjoint representation give rise to physical vector multiplets. Our proposal here is to treat cohomology classes that live in a bifundamental representation as having the same physical and topological ghost number. We will see this is a useful perspective, at least at the level of F -terms.

It has been suggested in the literature that bifundamentals obtained from Ext^0 cohomology classes should correspond to tachyons. This is incompatible with the point of view taken here, since only fields of the right ghost number can get expectation values. In particular we wish to avoid giving expectation values to gauge redundancies.

2.3 Review of Seiberg duality and mutations

We have assumed the existence of a set of boundary states $\{F_1, \dots, F_n\}$ which gets mapped to an exceptional collection in the large volume limit. However for any given singularity there are infinitely many such collections. This is actually not completely surprising, because so far we have only really defined the complex structure of the local singularity, and all collections contain the same holomorphic information. The existence of many collections for a given singularity reflects the fact that there are many points in the Kähler moduli space where the cycles are collapsed to zero size. If we interpolate between such points, the basis of vanishing cycles may undergo a Picard–Lefschetz monodromy. The collection $\{F_1, \dots, F_n\}$ comes with an ordering, and the effect of the monodromy is that a sheaf may be moved to the left or to the right in the collection. When a sheaf F_i is moved to the left or to the right, we end up with a new exceptional collection

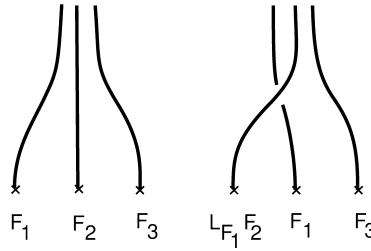

Figure 2: A braiding operation on the collection of fractional branes. These pictures can be interpreted in terms of D6 branes wrapped on Lagrangian cycles in the mirror [15].

$\{F_1, \dots, L_{F_{i-1}} F_i, F_{i-1}, F_{i+1}, \dots, F_n\}$ or $\{F_1, \dots, F_{i-1}, F_{i+1}, R_{F_{i+1}} F_i, \dots, F_n\}$, as indicated in figure 2.

The charge vector of the new sheaf is given by the characteristic Picard–Lefschetz formula:

$$\text{ch}(F_i) \rightarrow \text{ch}(L_{F_{i-1}} F_i) = \pm[\text{ch}(F_i) - \chi(F_i, F_{i-1})\text{ch}(F_{i-1})]. \tag{2.11}$$

Such a monodromy arises around a locus in the moduli space where the central charge of F_{i-1} (i.e., its period) goes to zero. An action on sheaves which has the effect of (2.11) on the charge vectors is called a mutation or a braiding operation. A mutation turns one exceptional collection into another, and (up to some “trivial” operations like tensoring the whole collection with a line bundle) for the cases we consider all exceptional collections may be related through a sequence of mutations. However a Picard–Lefschetz monodromy is typically a composition of a few mutations; not every individual mutation may be realized as a monodromy in the Kähler moduli space.

Once we specify both the complex and the Kähler structure of the local geometry the collection should be uniquely specified. The idea is that an exceptional collection becomes valid if the corresponding fractional branes become mutually supersymmetric, i.e., if the periods of the fractional branes (which depend on the Kähler moduli) line up in the complex plane and have the same phase. Evidence for this picture has been given in [16, 17]. Now suppose further that we take a path in moduli space so that the absolute value of a period of one of the fractional branes goes to zero. Then we expect to get a new collection related by a Picard–Lefschetz monodromy and hence a different quiver gauge theory. The gauge theory interpretation of this is that the gauge coupling associated with the corresponding node blows up, and we get a new quiver related by Seiberg duality to the old one.

Now we can see why only a subset of mutations appears to be realized through monodromies in the Kähler moduli space. Suppose we want to do a

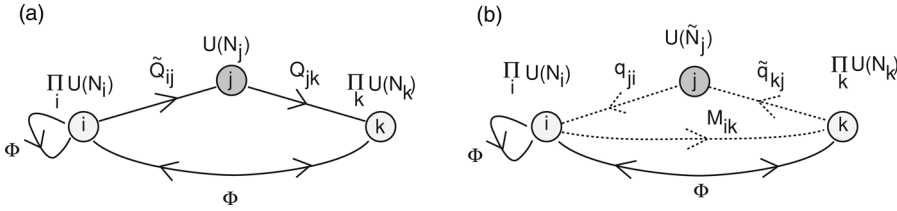

Figure 3: (a) Organizing the nodes before applying a Seiberg duality. (b) The quarks Q are replaced by the dual quarks q and the mesons $M = Q\tilde{Q}$, and the gauge group is changed from $SU(N_c)$ to $SU(N_f - N_c)$.

Seiberg duality on node j (see figure 3). Let us organize the quiver so that all the incoming arrows are all to the left of j , and all the outgoing arrows are to the right of j . Then one can show [4] that a Seiberg duality corresponds to a mutation by j of either (1) all the nodes to the left, or (2) all the nodes on the right.⁴ If we decide to perform a mutation on only a few of the nodes on the left or on the right, then we end up with a quiver with ghosts, for which there does not seem to be a physical interpretation. Nevertheless as we have explained it is possible at the level of F -terms to make sense out of quivers with ghosts, and all such quivers are related through mutations which are not Seiberg dualities. We can therefore view mutations as a “generalized Seiberg duality.” Since there typically are quivers with ghosts that are very easy to calculate, then we can use generalized Seiberg dualities as a technique for deriving ordinary physical quiver gauge theories without ghosts. This will be explained in Section 4.

2.4 Holomorphic deformations of quiver theories

A quiver gauge theory admits a large number of deformations. Here we are interested in deformations of the F -terms, i.e., ratios of superpotential couplings that are invariant under field redefinitions. Such deformations should be given by perturbing the closed string B-model by vertex operators of ghost number 2. The BRST cohomology at ghost number 2 lives in the following cohomology groups [18]:

$$\sum_{i+j=2} H^i(X, \Lambda^j T_X) = H^0(X, \Lambda^2 T_X) \oplus H^1(X, T_X) \oplus H^2(X, \mathcal{O}_X), \quad (2.12)$$

⁴There may also be nodes which are not connected to node j by an arrow; such nodes are not changed under a Seiberg duality.

i.e., tensors of type μ^{ij}, μ_j^i or $\mu_{\bar{i}\bar{j}}$. The interpretation of these deformations is as follows:

- $H^1(X, T_X)$ counts classical complex structure deformations of X ;
- $H^0(X, \Lambda^2 T_X)$ counts global holomorphic Poisson structures, in other words, non-commutative deformations (inverse B -fields);
- $H^2(X, \mathcal{O}_X)$ counts “gerbe” deformations obtained by turning on a B -field with two anti-holomorphic indices.

We will further restrict ourselves to exactly marginal deformations of the conformal theory living on N D3-branes placed at the singularity. Since the radial direction away from the singularity has the interpretation of an energy scale, the scale invariance of the SCFT means that the local geometry is that of a complex cone over a compact complex surface. Marginal deformations will preserve this structure, and so such deformations correspond to deformations of the complex surface.⁵

It must be emphasized that there are plenty of other F -term deformations that are not of this type, and that can become large either close to the tip of the cone or very far away. For instance, we could be interested in adding fractional branes which lead to non-perturbative behavior in the IR triggering an extremal transition; or we could be interested in adding relevant or irrelevant terms to the superpotential, such as mass terms for the adjoints in $N = 4$ YM theory (i.e., the $N = 1^*$ and $N = 2^*$ deformations). All these cases are captured by the B-model, generically on a generalized geometry. But here we will restrict ourselves to scale invariant deformations.

The main class of examples that we consider in detail are the Del Pezzo singularities. Recall that a Del Pezzo surface is either a \mathbf{P}^2 blown up at k points (often denoted \mathcal{B}_k) or $\mathbf{P}^1 \times \mathbf{P}^1$ (often denoted as \mathbf{F}_0). On such a surface $h^2(X, \mathcal{O}_X) = h^{(0,2)} = 0$ so we do not get any gerbe deformations. On \mathcal{B}_k we naively expect $2k$ complex structure parameters (describing the position of k points on \mathbf{P}^2) and $10 - k$ NC deformations (since $\Lambda^2 T_X$ is isomorphic to the line bundle of cubic homogeneous polynomials that vanish at the points that get blown up). Finally the group $PGL(3, \mathbf{C})$ of holomorphic co-ordinate redefinitions kills eight of these parameters, so in total we expect $k + 2$ deformations for \mathcal{B}_k . Similarly for \mathbf{F}_0 there are three deformations. This agrees with the allowed number of deformations that one can read off from the quiver diagram, as one can check easily.

⁵For \mathcal{B}_1 and \mathcal{B}_2 it appears that some of the operators we use to deform the superpotential do not have R -charge exactly equal to 2. This is related to the fact that the parameter that simply rescales the complex variables is not exactly the radial direction in the Calabi–Yau metric in these examples. We thank Sergio Benvenuti for pointing this out.

3 Non-commutative singularities and deformations of superpotentials

3.1 Non-commutative deformations

First we need to discuss some basic properties of non-commutative algebraic geometry. See [19] for a more rigorous review. The first case we will consider is \mathbf{C}^3/Z_3 which has a collapsed \mathbf{P}^2 . Suppose we have a brane that wraps \mathbf{P}^2 and suppose we turn on a B -field with purely holomorphic indices. We will extend the inverse B -field to the Calabi–Yau threefold by making it independent of the radial co-ordinate of the Calabi–Yau and its complex partner. Then we effectively only need to specify it on \mathbf{P}^2 , where $\theta^{ij} \sim (B^{-1})^{ij}$ is a section of $\Lambda^2 T_{\mathbf{P}^2}$. This bundle has many holomorphic sections which we can use to deform the sigma model. The general effect of turning on θ^{ij} is to deform the left- and right-moving $N = 2$ algebra on the worldsheet so that the left- and right-moving complex structures are no longer equal [20, 21]. Geometrically this situation can be described using generalized complex geometry [22, 23]. For the purposes of this paper we are interested in the effect of turning on θ^{ij} on open strings. Then we expect the co-ordinates on \mathbf{P}^2 to become non-commutative according to

$$[x^i, x^j] = \theta^{ij}(x). \quad (3.1)$$

Here x^i, x^j are local co-ordinates; e.g., in the patch $z^3 \neq 0$ they are of the form $(z^3)^{-1}z^1, (z^3)^{-1}z^2$. If θ^{ij} is holomorphic then this is a type of complex structure deformation and should make an appearance in the superpotential.

It will be convenient to express the commutation relations in projective co-ordinates rather than local co-ordinates. It is known that a generic NC structure on \mathbf{P}^2 can be put in the form [24]

$$\begin{aligned} \alpha z_1 z_2 + \beta z_2 z_1 + \gamma z_3^2 &= 0 \\ \alpha z_2 z_3 + \beta z_3 z_2 + \gamma z_1^2 &= 0 \\ \alpha z_3 z_1 + \beta z_1 z_3 + \gamma z_2^2 &= 0 \end{aligned} \quad (3.2)$$

which is known as an “elliptic algebra” or a “Sklyanin algebra.” These equations are familiar from the F -term equations for the Leigh–Strassler deformations of $N = 4$ Yang–Mills theory [25], which is indeed known to be related to non-commutative deformations [6]. In fact the Leigh–Strassler deformations are invariant under the trihedral group Δ_{27} ,⁶ and when we orbifold by a Z_3 subgroup to get \mathbf{C}^3/Z_3 the Leigh–Strassler deformations descend to the NC deformations of the quotient. Nevertheless it will be useful to proceed

⁶We would like to thank Sergio Benvenuti for pointing this out to us.

with our point of view because it can easily be extended to non-orbifold singularities.

When writing homogeneous equations in non-commutative co-ordinates, one can assign an integer grade to a co-ordinate depending on which position in a monomial it appears. In this subsection, we will denote a co-ordinate in the first position as A^i and a co-ordinate in the second position as B^i . It will be evident shortly why this is a useful thing to do.

Then we may rewrite the previous equations (3.2) as

$$\begin{pmatrix} \beta A^2 & \alpha A^1 & \gamma A^3 \\ \gamma A^1 & \beta A^3 & \alpha A^2 \\ \alpha A^3 & \gamma A^2 & \beta A^1 \end{pmatrix} \cdot \begin{pmatrix} B^1 \\ B^2 \\ B^3 \end{pmatrix} \equiv f_{ijk} A^i B^j = 0. \tag{3.3}$$

These equations determine a variety in $\mathbf{P}_A^2 \times \mathbf{P}_B^2$ which one can think of as the graph of a linear isomorphism of a certain elliptic curve. The elliptic curve is given by $A^i \in \mathbf{P}_A^2 \det(f_{ijk} A^i) = 0$, which gives

$$\alpha\beta\gamma((A^1)^3 + (A^2)^3 + (A^3)^3) - (\alpha^3 + \beta^3 + \gamma^3)A^1 A^2 A^3 = 0. \tag{3.4}$$

If A^i lies on this elliptic curve, the matrix $f_{ijk} A^i$ has rank 2, so it has a one-dimensional kernel spanned by some vector $B_A^i \in \mathbf{P}_B^2$. Note that B_A^i must lie on the elliptic curve $\det(f_{ijk} B^j) = 0$, i.e.,

$$\alpha\beta\gamma((B^1)^3 + (B^2)^3 + (B^3)^3) - (\alpha^3 + \beta^3 + \gamma^3)B^1 B^2 B^3 = 0 \tag{3.5}$$

Therefore, f_{ijk} determines an automorphism of the elliptic curve, given by

$$\sigma(A^i) = B_A^i. \tag{3.6}$$

To abbreviate the notation, we will often write $\sigma(A^i) = (A^\sigma)^i$.

The elliptic curve and the automorphism (which can be thought of as translating by some point η on the curve) completely characterize the NC structure on \mathbf{P}^2 . Clearly we have for any point p on the elliptic curve (3.4)

$$f_{ijk} p^i (p^\sigma)^j = 0. \tag{3.7}$$

Thus intuitively the NC structure degenerates along the elliptic curve we have discussed, and we can think of this curve as an embedded commutative curve. The more precise statement is that the twisted homogeneous co-ordinate ring of the curve is equivalent to a commutative ring, in that it has the same modules [19].

It is possible to give a more explicit parametrization of p^σ for general p by uniformizing the elliptic curve using θ -functions. See [26] for details.

3.2 The projective plane

For \mathbf{P}^2 we will take the customary exceptional collection

$$1. \mathcal{O}(0) \quad 2. T(-1) \quad 3. \mathcal{O}(1). \tag{3.8}$$

The maps are given by

$$X_{12} = A^i \partial_i \quad X_{23} = \langle \bullet, B^j \partial_j \rangle \quad X_{13} = C_k z^k. \tag{3.9}$$

Here we have written the NC deformation of the identification $\Lambda^2 T_X \otimes \mathcal{O}(2) \sim \mathcal{O}(1)$ as $\langle \partial_i, \partial_j \rangle = g_{ijk} z^k$ for some tensor g_{ijk} . In the commutative case, $f_{ijk} = \epsilon_{ijk}$, but in the non-commutative one needs some care in defining the bundles and this relation will be continuously deformed. Since $z^i \partial_i$ is a trivial tangent vector, we have $g_{ijk} z^j z^k = g_{ijk} z^i z^k = 0$, hence $g_{ijk} = f_{ijk}$.

From the composition of maps one finds the expected superpotential

$$W = f_{ijk} A^i B^j C^k. \tag{3.10}$$

We can rewrite this as

$$\begin{aligned} W &= \lambda_1 \epsilon_{ijk} A^i B^j C^k + \lambda_2 s_{ijk} A^i B^j C^k \\ &+ \lambda_3 (A^1 B^1 C^1 + A^2 B^2 C^2 + A^3 B^3 C^3) \end{aligned} \tag{3.11}$$

where $s_{ijk} = |\epsilon_{ijk}|$ is a symmetric tensor. As mentioned before these are just the Leigh–Strassler deformations of $N = 4$ Yang–Mills orbifolded by Z_3 . A deformation by λ_2 is called the β -deformation [27, 28].

To find the moduli space we should solve the F- and D-term equations. Let us just consider the case of a single D3-brane. We can be brief because the F -term equations for C^k were already discussed in the previous subsection. The result of that discussion was that for generic values of the NC parameters the set of solutions is just the embedded commutative curve in \mathbf{P}^2 . If we also consider VEVs for C^k then we can also move the D3-brane in the radial direction and the moduli space is just the cone over the elliptic curve. For a larger number of D3-branes one obtains a much more interesting structure

however, for instance for special discrete values of the NC parameters new branches seem to open up where the branes form some fuzzy geometry [29]. Such structure should appear when the automorphism σ is of finite order. In the context of mass deformations of $N = 4$ Yang–Mills theory ($N = 1^*$) this was first investigated in [30], and in the context of marginal deformations this was investigated in [7, 31, 32].

The fact that the superpotential is built on f_{ijk} is actually not too surprising. Even though the $PGL(3, \mathbf{C})$ symmetry of the \mathbf{P}^2 is broken, there is still a quantum group symmetry that uniquely fixes the superpotential. The tensor f_{ijk} corresponds to the quantum determinant $\mathbf{3} \otimes \mathbf{3} \otimes \mathbf{3} \rightarrow \mathbf{C}$.

3.3 The projective plane, revisited

If we take the exceptional collection $\{\mathcal{O}(0), T(-1), \mathcal{O}(1)\}$ and move $T(-1)$ one spot to the right, we get the exceptional collection

$$1. \mathcal{O}(0) \quad 3.\mathcal{O}(1) \quad 2.\mathcal{O}(2) \tag{3.12}$$

where $\mathcal{O}(2) = R_{\mathcal{O}(1)}T(-1)$. Let us try to understand the quiver directly from this collection.

In order to describe a D3 brane, we consider the resolution

$$\mathcal{O}(0)[-2] \rightarrow \mathcal{O}(1)^2[-1] \rightarrow \mathcal{O}(2)[0] \rightarrow \mathcal{O}_p. \tag{3.13}$$

Taking into account the shifts in the derived category (spectral flow), we get

$$\begin{aligned} \text{Hom}(\mathcal{O}(0), \mathcal{O}(1)) &\rightarrow N_{gh} = 0 - (-2) + (-1) = +1 \\ \text{Hom}(\mathcal{O}(1), \mathcal{O}(2)) &\rightarrow N_{gh} = 0 - (-1) + 0 = +1 \\ \text{Hom}(\mathcal{O}(0), \mathcal{O}(2))^* &\rightarrow N_{gh} = 3 - (0 - (-2) + 0) = +1. \end{aligned} \tag{3.14}$$

Therefore the bifundamentals all come from BRST cohomology classes at ghost number one, as required. The associated quiver diagram is drawn in figure 4(b). We have the maps

$$X_{13} = A_i z^i \quad X_{32} = B_i z^i \quad X_{12} = C_{ij} z^i z^j. \tag{3.15}$$

Here we defined $C_{ij}^* = C^{ij}$ to have nine components, whereas $\mathcal{O}(2H)$ has only six generators. We can account for the difference by adding three Lagrange

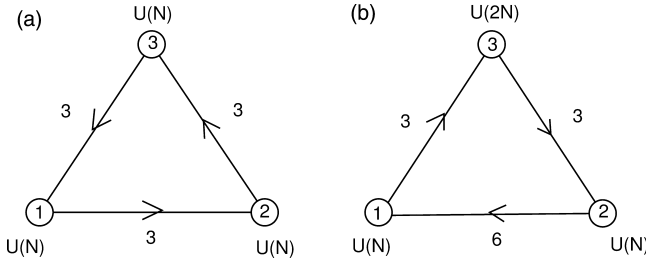

Figure 4: (a) Quiver diagram associated to the exceptional collection (3.8). (b) Dual quiver diagram, obtained from (a) by Seiberg duality on node 3.

multiplier fields Z_1, Z_2, Z_3 and adding the following mass terms to the superpotential:

$$W_{\text{mass}} = f_{ijk} C^{ij} Z^k. \tag{3.16}$$

Then we have the following non-commutative generalization of the usual superpotential:

$$W = A_i B_j C^{ij} + f_{ijk} C^{ij} Z^k. \tag{3.17}$$

If desired one can explicitly integrate out massive fields. If we solve for C^{21}, C^{31} and C^{32} , we obtain

$$\begin{aligned} W &= (\beta A_1 B_1 - \gamma A_3 B_2) C^{11} + (\beta A_1 B_2 - \alpha A_2 B_1) C^{12} \\ &\quad + (-\alpha A_1 B_3 + \beta A_3 B_1) C^{13} + (\beta A_2 B_2 - \gamma A_1 B_3) C^{22} \\ &\quad + (\beta A_2 B_3 - \alpha A_3 B_2) C^{23} + (\beta A_3 B_3 - \gamma A_2 B_1) C^{33}. \end{aligned} \tag{3.18}$$

If there is a quantum group symmetry, the superpotential is again the unique one obtained from picking the singlet in the tensor product of representations $\mathbf{3} \otimes \mathbf{3} \otimes \mathbf{6}$.

Let us briefly check that this result agrees with the previous section. If we perform a Seiberg duality on node 3 we should reproduce the Z_3 symmetric quiver. Thus we replace $A_i B_j$ by the meson fields M_{ij} , add the dual quarks \tilde{A}^i, \tilde{B}^j and modify the superpotential:

$$W_{\text{dual}} = M_{ij} C^{ij} + f_{ijk} C^{ij} Z^k + \tilde{B}^i \tilde{A}^j M_{ij}. \tag{3.19}$$

After integrating out M_{ij}, C^{ij} , we obtain

$$W_{\text{dual}} = -f_{ijk} \tilde{B}^i \tilde{A}^j Z^k \tag{3.20}$$

which is, up to some simple field redefinitions, identical to the superpotential we obtained earlier.

3.4 $\mathbf{P}^1 \times \mathbf{P}^1$

We take the customary collection

$$\begin{matrix} 1.\mathcal{O}(0,0) & 2.\mathcal{O}(0,1) & 4.\mathcal{O}(1,1). \\ & 3.\mathcal{O}(1,0) & \end{matrix} \tag{3.21}$$

The quiver diagram is drawn in figure 5. A look at the standard quiver diagram reveals a three-dimensional space of marginal deformations of the superpotential modulo field redefinitions. This agrees with the geometry: there is a nine-dimensional space of Poisson deformations. Subtracting the six-dimensional space of co-ordinate redefinitions leaves three parameters.

Constructing the superpotential is relatively easy. The discussion closely mirrors the case of \mathbf{P}^2 . Let us denote the co-ordinates on the “left” \mathbf{P}^1 by z^α and the co-ordinates on the “right” \mathbf{P}^1 by w^β . Then we may define a non-commutative structure through the equations

$$\begin{aligned} 0 &= w^1 z^1 + \alpha z^1 w^1 + \delta z^2 w^2 \\ 0 &= w^2 z^1 + \beta z^1 w^2 + \gamma z^2 w^1 \\ 0 &= w^1 z^2 + \beta z^2 w^1 + \gamma z^1 w^2 \\ 0 &= w^2 z^2 + \delta z^1 w^1 + \alpha z^2 w^2. \end{aligned} \tag{3.22}$$

We can write this as

$$\begin{pmatrix} w^1 & 0 & \alpha z^1 & \delta z^2 \\ w^2 & 0 & \gamma z^2 & \beta z^1 \\ 0 & w^1 & \beta z^2 & \gamma z^1 \\ 0 & w^2 & \delta z^1 & \alpha z^2 \end{pmatrix} \cdot \begin{pmatrix} z^1 \\ z^2 \\ w^1 \\ w^2 \end{pmatrix} = 0. \tag{3.23}$$

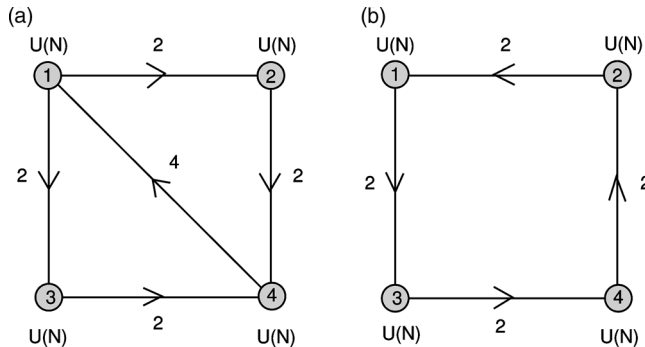

Figure 5: (a) Quiver associated with the collection (3.21). (b) Quiver obtained from (a) by Seiberg duality on node 2.

The determinant of the matrix is an equation of bidegree (2,2) which is an elliptic curve in $\mathbf{P}^1 \times \mathbf{P}^1$. This is the embedded commutative curve where the Poisson structure degenerates. For every point on this curve, the matrix has a unique eigenvector, which determines a point in $\mathbf{P}^1 \times \mathbf{P}^1$. The set of points obtained this way also forms an elliptic curve, and the correspondence point \rightarrow eigenvector again yields an automorphism of the elliptic curve which we denote by σ .

Now we use this to calculate the superpotential. The Ext generators are given by

$$\begin{aligned} X_{13} &= A_\alpha z^\alpha & X_{12} &= C_{\dot{\alpha}} w^{\dot{\alpha}} \\ X_{34} &= B_{\dot{\alpha}} w^{\dot{\alpha}} & X_{24} &= D_\alpha z^\alpha \\ X_{14} &= E_{\alpha\dot{\beta}} z^\alpha w^{\dot{\beta}}. \end{aligned} \tag{3.24}$$

The superpotential is then

$$\begin{aligned} W &= (C_1 D_1 + \alpha A_1 B_1 + \delta A_2 B_2) E^{11} \\ &\quad + (C_2 D_1 + \beta A_1 B_2 + \gamma A_2 B_1) E^{12} \\ &\quad + (C_1 D_2 + \beta A_2 B_1 + \gamma A_1 B_2) E^{21} \\ &\quad + (C_2 D_2 + \delta A_1 B_1 + \alpha A_2 B_2) E^{22}. \end{aligned} \tag{3.25}$$

It is clear that the NC relations (3.22) translate directly into superpotential terms. The earlier discussion therefore implies that the moduli space is simply the (cone over the) embedded commutative elliptic curve.

Before closing this section let us discuss the quiver one obtains from a Seiberg duality on node 2. The quiver is drawn in figure 5(b) and the superpotential is given by

$$\begin{aligned} W_{\text{dual}} &= \lambda_1 (A_1 B_1 C_2 D_2 - A_1 B_2 C_2 D_1 + A_2 B_2 C_1 D_1 - A_2 B_1 C_1 D_2) \\ &\quad + \lambda_2 (A_1 B_1 C_2 D_2 + A_1 B_2 C_2 D_1 - A_1 B_2 C_1 D_2 - A_2 B_1 C_2 D_1 \\ &\quad \quad + A_2 B_2 C_1 D_1 + A_2 B_1 C_1 D_2 - A_1 B_2 C_1 D_2 - A_2 B_1 C_2 D_1) \\ &\quad + \lambda_3 (A_1 B_1 C_2 D_2 + A_1 B_2 C_2 D_1 + A_2 B_2 C_1 D_1 + A_2 B_1 C_1 D_2) \\ &\quad + \lambda_4 (A_1 B_1 C_1 D_1 + A_2 B_2 C_2 D_2) \end{aligned} \tag{3.26}$$

with

$$\begin{aligned} \alpha &= -\lambda_1 + \lambda_2 + \lambda_3 & \gamma &= -2\lambda_2 \\ \beta &= \lambda_1 + \lambda_2 + \lambda_3 & \delta &= \lambda_4. \end{aligned} \tag{3.27}$$

This quiver is related to the conifold singularity by a Z_2 orbifold. Thus for our next example we turn to the conifold.

The NC deformations break the $PGL(2, \mathbf{C}) \times PGL(2, \mathbf{C})$ symmetry of the complex structure. However at least for a subset of the NC parameters there should still be a quantum group symmetry.

3.5 The conifold

The surface $\mathbf{P}^1 \times \mathbf{P}^1$ can be embedded in \mathbf{P}^3 through the Segre embedding. Namely if we define $x^{\alpha\beta} = z^\alpha w^\beta$ then the image of $\mathbf{P}^1 \times \mathbf{P}^1$ is given by the quadric surface $x^{11}x^{22} - x^{12}x^{21} = 0 \in \mathbf{P}^3$. If we regard this as an equation in affine four-space then we do not get the cone over $\mathbf{P}^1 \times \mathbf{P}^1$ but a double cover of it. This is of course the well-known conifold singularity. To recover the cone over $\mathbf{P}^1 \times \mathbf{P}^1$, we have to perform a Z_2 orbifold of the conifold, given by $x^{\alpha\beta} \rightarrow -x^{\alpha\beta}$. We can use the Z_2 orbifolding to obtain the quiver diagram 5(b) from the conifold quiver, or conversely we can recover the conifold quiver from 5(b) by modding out by the Z_2 quantum symmetry, which identifies the fields $A_i = C_i$ and $B_j = D_j$. The resulting quiver is drawn in figure 6.

The space of marginal deformations of the superpotential has already been examined [27], and it was found that there exists a three-parameter family of deformations, just as we found for the quadric. In fact, we can use the fact that the quivers are related by a Z_2 quotient to map the deformations into each other. Thus we get the following superpotential for the conifold quiver:

$$\begin{aligned}
 W_{\text{conifold}} = & 2\lambda_1(A_1B_1A_2B_2 - A_1B_2A_2B_1) \\
 & + 2\lambda_2(A_1B_1A_2B_2 + A_1B_2A_2B_1 - A_1B_2A_1B_2 - A_2B_1A_2B_1) \\
 & + 2\lambda_3(A_1B_1A_2B_2 + A_1B_2A_2B_1) \\
 & + \lambda_4(A_1B_1A_1B_1 + A_2B_2A_2B_2).
 \end{aligned}
 \tag{3.28}$$

The same idea can now be used to obtain the NC structures on the conifold. Again we define $x^{\alpha\beta} = z^\alpha w^\beta$ except that z^α, w^β no longer commute

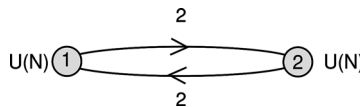

Figure 6: The well-known conifold quiver, a Z_2 quotient of figure 5(b).

but instead satisfy (3.22). This will lead to a deformation of the seven equations $x^{11}x^{22} - x^{12}x^{21} = 0$ and $x^{\alpha\beta}x^{\gamma\delta} - x^{\gamma\delta}x^{\alpha\beta} = 0$. Using a Gröbner basis computation we find the following relations:

$$\begin{aligned}
 0 &= \alpha (\gamma^2 - \beta^2) x^{2\dot{1}}x^{1\dot{2}} + \gamma (\delta^2 - \alpha^2) x^{2\dot{1}}x^{2\dot{1}} + \beta (\alpha^2 - \delta^2) x^{2\dot{2}}x^{1\dot{1}} \\
 &\quad + \delta (\beta^2 - \gamma^2) x^{2\dot{2}}x^{2\dot{2}} \\
 0 &= \delta (\beta^2 - \gamma^2) x^{2\dot{1}}x^{1\dot{1}} + \beta (\alpha^2 - \delta^2) x^{2\dot{1}}x^{2\dot{2}} + \gamma (\delta^2 - \alpha^2) x^{2\dot{2}}x^{1\dot{2}} \\
 &\quad + \alpha (\gamma^2 - \beta^2) x^{2\dot{2}}x^{2\dot{1}} \\
 0 &= -\delta x^{1\dot{2}}x^{1\dot{1}} + \beta x^{1\dot{2}}x^{2\dot{2}} - \alpha x^{2\dot{2}}x^{1\dot{2}} + \gamma x^{2\dot{2}}x^{2\dot{1}} \\
 0 &= -\beta x^{1\dot{1}}x^{2\dot{2}} + \gamma x^{1\dot{2}}x^{1\dot{2}} - \gamma x^{2\dot{1}}x^{2\dot{1}} + \beta x^{2\dot{2}}x^{1\dot{1}} \\
 0 &= -\delta x^{1\dot{1}}x^{2\dot{1}} + \gamma x^{1\dot{2}}x^{2\dot{2}} - \alpha x^{2\dot{1}}x^{2\dot{2}} + \beta x^{2\dot{2}}x^{2\dot{1}} \\
 0 &= \delta (\gamma^2 - \beta^2) x^{1\dot{1}}x^{1\dot{2}} + \alpha (\beta^2 - \gamma^2) x^{1\dot{2}}x^{2\dot{2}} + \gamma (\alpha^2 - \delta^2) x^{2\dot{1}}x^{2\dot{2}} \\
 &\quad + \beta (\delta^2 - \alpha^2) x^{2\dot{2}}x^{1\dot{2}} \\
 0 &= \delta (\beta^2 - \gamma^2) x^{1\dot{1}}x^{1\dot{1}} + \alpha (\gamma^2 - \beta^2) x^{1\dot{2}}x^{2\dot{1}} + \gamma (\delta^2 - \alpha^2) x^{2\dot{1}}x^{2\dot{1}} \\
 &\quad + \beta (\alpha^2 - \delta^2) x^{2\dot{2}}x^{1\dot{1}}.
 \end{aligned} \tag{3.29}$$

Alternatively one could start with a non-commutative structure on \mathbf{C}^4 , perform an NC small resolution of the conifold, and use the method of [33] to derive the superpotential. This is algebraically more complicated, so we chose to exploit the relation to $\mathbf{P}^1 \times \mathbf{P}^1$.

For the quadric (and hence, through our earlier remark, for the conifold) mathematicians have developed the following picture [19]: we start with the four-dimensional Sklyanin algebra, which defines a non-commutative structure on \mathbf{C}^4 :

$$\begin{aligned}
 x^0x^1 - x^1x^0 &= \alpha_1(x^2x^3 + x^3x^2) \\
 x^0x^2 - x^2x^0 &= \alpha_2(x^3x^1 + x^1x^3) \\
 x^0x^3 - x^3x^0 &= \alpha_3(x^1x^2 + x^2x^1) \\
 x^2x^3 - x^3x^2 &= x^0x^1 + x^1x^0 \\
 x^3x^1 - x^1x^3 &= x^0x^2 + x^2x^0 \\
 x^1x^2 - x^2x^1 &= x^0x^3 + x^3x^0
 \end{aligned} \tag{3.30}$$

where the α_i are parameters satisfying $\alpha_1 + \alpha_2 + \alpha_3 + \alpha_1\alpha_2\alpha_3 = 0$. The center of this algebra is generated by two quadratic Casimir elements

$$C_1 = x_0^2 + J_1x_1^2 + J_2x_2^2 + J_3x_3^2, \quad C_2 = x_1^2 + x_2^2 + x_3^2. \tag{3.31}$$

The J_i can be determined in terms of the α_i . This defines a three-parameter family of NC structures on the conifold $C_1 + \lambda C_2 = 0$. If desired, one can do a co-ordinate transformation so that the conifold is written in the standard form and all the parameters appear in the Sklyanin algebra. To get the NC structures on the cone over the quadric we should simply quotient by $x^i \rightarrow -x^i$. The locus $C_1 = C_2 = 0$ is the embedded commutative locus, a cone over the elliptic curve in the quadric. If we put a single D3-brane at the singularity, then this commutative locus is generically the moduli space of the gauge theory. Presumably $\{x^i, \alpha_i, \lambda\}$ and our variables $\{x^{\alpha\beta}, \alpha, \beta, \gamma, \delta\}$ are related through co-ordinate redefinitions.

It is also interesting to consider the non-commutative analog of the conifold transition [34–36]. To this end one puts M fractional D3-branes and one ordinary D3-brane at the conifold. This yields the same quiver theory except that the gauge group is $U(M + 1) \times U(1)$. In the IR this is effectively an $SU(M + 1)$ gauge theory with two quarks and two anti-quarks. Therefore we expect that the Affleck–Dine–Seiberg superpotential gets generated and our total superpotential is

$$W_{\text{total}} = W_{\text{conifold}} + (M - 1) \left(\frac{2\Lambda^{3M+1}}{\det(A_\alpha B_\beta)} \right)^{1/M-1}. \tag{3.32}$$

Now how can we find the deformation of the equations that define the NC conifold? Note that the NC conifold is not (a component) of the moduli space of this theory, since the D3-brane can only move on the locus where the NC structure degenerates. On the other hand, it is not hard to guess what it must be. To get a consistent equation, we can only deform $C_1 + \lambda C_2 = 0$ by adding other Casimirs of the Sklyanin algebra.⁷ Moreover, instanton corrections come with a positive power of Λ , so by dimension counting it must multiply a Casimir of degree less than two (the couplings λ_i are dimensionless). Then the deformation should be of the form

$$C_1 + \lambda C_2 = a(\Lambda^{3M+1})^{1/M} \mathbf{1}. \tag{3.33}$$

The power of Λ is the same as in [34]. Since the coefficient a is non-zero in the commutative limit, it should be non-zero in the non-commutative case also. Note that all the equations are invariant under $x^i \rightarrow -x^i$, so we also expect a transition when we put fractional branes at the non-commutative collapsed $\mathbf{P}^1 \times \mathbf{P}^1$ singularity.

⁷We expect that the Sklyanin algebra itself cannot be deformed by non-perturbative corrections, however we have not proven this statement.

3.6 Blow-ups of \mathbb{P}^2

One can only blow-up commutative points [19], i.e., the points must lie on the elliptic curve where the NC structure degenerates. We will discuss a three-block exceptional collection on Del Pezzo 3 as our main representative of the higher Del Pezzos. As was shown in [2] the calculations up to Del Pezzo 6 are all extremely similar to this case.

A simple three-block exceptional collection of line bundles is given by

$$\begin{aligned}
 &1. \mathcal{O} \quad 2. \mathcal{O}(H - E_1) \quad 5. \mathcal{O}(H) \\
 &3. \mathcal{O}(H - E_2) \quad 6. \mathcal{O}(2H - E_1 - E_2 - E_3). \\
 &4. \mathcal{O}(H - E_3)
 \end{aligned}
 \tag{3.34}$$

The exceptional curves E_1, E_2 and E_3 are obtained by blowing up the points p, q and r . A basis for the linear sections can be constructed as follows:

$$\begin{aligned}
 X_{12} &= A_i z^i & X_{25} &= 1 & X_{26} &= \epsilon_{ijk} (q^\sigma)^i (r^\sigma)^j z^k \\
 X_{13} &= B_i z^i & X_{35} &= 1 & X_{36} &= \epsilon_{ijk} (r^\sigma)^i (p^\sigma)^j z^k \\
 X_{14} &= C_i z^i & X_{45} &= 1 & X_{46} &= \epsilon_{ijk} (p^\sigma)^i (q^\sigma)^j z^k \\
 X_{15} &= D_i z^i
 \end{aligned}
 \tag{3.35}$$

Note that for X_{12}, X_{13}, X_{14} we also added a generator which does not vanish at p, q, r respectively. We can kill these generators by adding Lagrange multiplier fields V_1, V_2, V_3 and mass terms

$$p^i A_i V_1 + q^i B_i V_2 + r^i C_i V_3
 \tag{3.36}$$

to the superpotential. We could of course work directly with the massless generators, but the reason for doing it this way is that we can write the superpotential in a much more symmetric form.

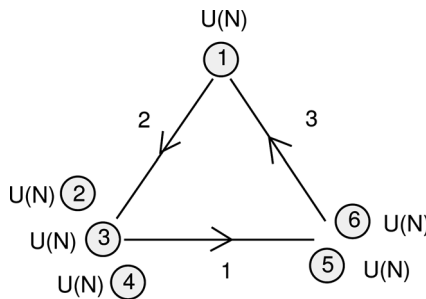

Figure 7: Quiver for Del Pezzo 3 associated to the exceptional collection (3.34).

Finally we need the quadratic generators X_{16} , which are of course more tricky. Sections of $\mathcal{O}(2H - E_1 - E_2 - E_3)$ are of the form $a_{ij}z^i z^j$, subject to the three conditions

$$a_{ij}p^i(p^\sigma)^j = 0, \quad a_{ij}q^i(q^\sigma)^j = 0, \quad a_{ij}r^i(r^\sigma)^j = 0. \quad (3.37)$$

A simple way to proceed is as follows. First we add the additional sections of $\mathcal{O}(2H)$ that do not vanish at p, q, r . We introduce the following nine quadratic sections

$$X_{16} = E_{ij}z^i z^j \quad (3.38)$$

and add three Lagrange multipliers Z^1, Z^2, Z^3 and a mass term $f_{ijk}E^{ij}Z^k$ to get six massless fields. Then we introduce three additional fields Y_1, Y_2, Y_3 and add more mass terms to kill the sections that do not vanish at p, q, r . So in total we have

$$W_{\text{mass}} = p^i A_i V_1 + q^i B_i V_2 + r^i C_i V_3 + f_{ijk}E^{ij}Z^k + \bar{p}_i \bar{p}_j^\sigma E^{ij}Y_1 + \bar{q}_i \bar{q}_j^\sigma E^{ij}Y_2 + \bar{r}_i \bar{r}_j^\sigma E^{ij}Y_3. \quad (3.39)$$

Now it is straightforward to find the following superpotential:

$$W = W_{\text{mass}} + A_{12i}X_{25}D_{51}^i + B_{13i}X_{35}D_{51}^i + C_{14i}X_{45}D_{51}^i + \epsilon_{ijk}(q^\sigma)^i(r^\sigma)^j A_{12m}X_{26}E_{61}^{mk} + \epsilon_{ijk}(r^\sigma)^i(p^\sigma)^j B_{13m}X_{36}E_{61}^{mk} + \epsilon_{ijk}(p^\sigma)^i(q^\sigma)^j C_{14m}X_{46}E_{61}^{mk}. \quad (3.40)$$

In the commutative case we should set $f_{ijk} = \epsilon_{ijk}$, set the automorphism σ equal to the identity and integrate out the massive fields. In this case one reproduces calculations previously performed in [2], which are known to yield the expected superpotential.

By turning on an expectation value for X_{26}, X_{36} or X_{46} we get quiver theories for Del Pezzos with fewer blow-ups.

3.7 Abelian orbifolds

Consider the orbifold \mathbf{C}^3/Z_k where the co-ordinates of \mathbf{C}^3 are taken to have weights (w_1, w_2, w_3) under the action of Z_k (with $w_1 + w_2 + w_3 = k$). In order to derive the quiver gauge theory the simplest method is of course to use the projection methods of [37]. This is more powerful than the large volume description since we also get information about the D-terms. Nevertheless it will be useful to consider the large volume limit. Non-commutative deformations can be described in this framework, and it provides some

insights that should apply more generally to toric singularities and their deformations. For recent progress in the toric case see [38–40].

For $k > 3$ the orbifold \mathbf{C}^3/Z_k contains multiple vanishing four-cycles and we need multiple blow-ups in order to completely resolve the singularity. After a single blow-up we get a finite size $\mathbf{P}^2_{(w_1, w_2, w_3)}$ which typically has orbifold singularities, and further blow-ups are needed to remove these singularities. Nevertheless the weighted projective space $\mathbf{P}^2_{(w_1, w_2, w_3)}$ already has nice sets of exceptional collections that we can use to construct the quiver gauge theory, as we will now review [2, 41].

There are two canonical exceptional collections that are dual to each other. The first is a collection of invertible sheaves $\{R_1, \dots, R_k\} = \{\mathcal{O}(0), \dots, \mathcal{O}(k)\}$ which is called the bosonic basis. The non-zero cohomology groups are $\text{Hom}(R_i, R_j)$ which is generated by the polynomials of total degree $j - i$ in the co-ordinates z^i . The compositions of these maps are the obvious ones. The number of generators can be read off from the coefficient of h^{j-i} of the bosonic generating function (the Hilbert series of $\mathbf{P}^2_{(w_1, w_2, w_3)}$)

$$\chi = (1 - h^{w_1})^{-1}(1 - h^{w_2})^{-1}(1 - h^{w_3})^{-1}. \tag{3.41}$$

Although this exceptional collection is very simple it does not lead to physical quiver diagrams for $k > 3$. One could in principle use mutations to get a physical collection as explained in the section. However it is easier to use the other canonical basis which leads directly to the expected orbifold quiver.

The second collection is called the fermionic basis $\{S_1, \dots, S_k\}$. The exact definition of the S_i is a little murkier but they are roughly of the form $\Lambda^m T \otimes \mathcal{O}(n)$. However it is easy to say what the cohomology groups are: the non-zero ones are $\text{Hom}(S_i, S_j)$ which are generated by contractions with tangent vectors ι_{∂_i} of total degree $-(j - i)$.⁸ The number of generators can be read of from a fermionic generating function which is just the inverse of (3.41):

$$\chi^{-1} = (1 - h^{w_1})(1 - h^{w_2})(1 - h^{w_3}). \tag{3.42}$$

The fermionic basis can be obtained from the bosonic basis (up to tensoring by an invertible sheaf) by the mutations $\{S_1, \dots, S_k\} = \{L^{k-1}R_k, L^{k-2}R_{k-1}, \dots, R_1\}$. The collections are dual in the sense that $\chi(R_i, S_j) = \delta_{ij}$.

⁸This is dual to wedging with the differentials dz^i .

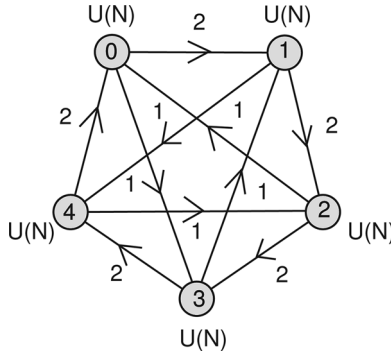

Figure 8: The Z_5 symmetric quiver of \mathbf{C}^3/Z_5 .

For generic (w_1, w_2, w_3) the orbifold \mathbf{C}^3/Z_k admits only one NC deformation:

$$xy = qyx, \quad yz = qzy, \quad zx = qxz. \tag{3.43}$$

The commutation relations of ι_{∂_i} can be deduced for instance from the fact that the fermionic basis is dual to the bosonic basis [42]:

$$\iota_{\partial_x} \iota_{\partial_y} = -q \iota_{\partial_y} \iota_{\partial_x}, \quad \iota_{\partial_y} \iota_{\partial_z} = -q \iota_{\partial_z} \iota_{\partial_y}, \quad \iota_{\partial_z} \iota_{\partial_x} = -q \iota_{\partial_x} \iota_{\partial_z}. \tag{3.44}$$

Using these relations, one finds a deformation of the orbifold theory. It is the same as the β -deformation. Let us consider as an example the orbifold \mathbf{C}^3/Z_5 , the extension to other cases being straightforward. We find the superpotential

$$\begin{aligned} W = & (Y_{01}X_{12} - qX_{01}Y_{12})Z_{20} + (Y_{12}X_{23} - qX_{12}Y_{23})Z_{31} \\ & + (Y_{23}X_{34} - qX_{23}Y_{34})Z_{42} + (Y_{34}X_{40} - qX_{34}Y_{40})Z_{03} \\ & + (Y_{40}X_{01} - qX_{40}Y_{01})Z_{14}. \end{aligned} \tag{3.45}$$

For special (w_1, w_2, w_3) there may exist additional deformations. We expect that if the non-commutative deformations are written as $f_{ijk}z^i z^j = 0$ then the superpotential is of the form $W = f_{ijk}X^i Y^j Z^k$, where X, Y, Z are the projected adjoint fields of the parent $N = 4$ theory.

4 Quivers with ghosts and generalized Seiberg dualities

One of the problems with simple exceptional collections is that they typically contain ghosts. Recall that when we build quiver diagrams out of a set of fractional branes, we must ensure that all the bifundamental fields correspond to vertex operators at ghost number one (in the derived category sense). If some of the bifundamentals have the wrong ghost number, we do not seem to be able to construct a sensible gauge theory.

Nevertheless we will show that one can consistently manipulate such quivers at the level of F -terms. As we discussed in Section 2, the idea is to say that every cohomology class of ghost number $p < 2$ on the Calabi–Yau gives rise to a chiral field in four dimensions with physical ghost number p .

The main objective here is to understand how the quiver theories for different exceptional collections are related. In order to do this we will first discuss the quiver for a brane/anti-brane pair.⁹ Basically the massless open strings between such a pair gives rise to a set of fields and ghost fields which cancel each other precisely. The field/ghost field pairs can then be used to rearrange the degrees of freedom in a quiver to a dual quiver.

Along the way we will also get a new perspective on Seiberg duality.

4.1 The brane/anti-brane quiver

Let us first consider a brane/anti-brane pair in isolation. Such a pair can be regarded as a complicated description of “nothing.”¹⁰ After that we will add such pairs of “nothing” to our quiver theories and use them to rearrange the degrees of freedom. The rearranged quiver will be the Seiberg dual theory of the original quiver.

Consider two identical copies of a brane, F_1 and F_2 . Then the massless spectrum is as follows: we have two ghost number zero operators $\text{Ext}^0(F_1, F_1)$ and $\text{Ext}^0(F_2, F_2)$ which are just the identity map. These correspond to the two $U(1)$ vector multiplets for each brane. We also have a generator from $\text{Ext}^0(F_1, F_2)$ and another from $\text{Ext}^0(F_2, F_1)$. These correspond to the W^\pm bosons, and altogether we therefore have a $U(2)$ vector multiplet.

Now we can apply one unit of spectral flow to one of the branes in order to turn it into an anti-brane (see figure 9). There are basically two choices, we can shift F_1 up or down with respect to F_2 . We will shift F_1 to $F_1[-1]$. The effect of this is to shift the ghost numbers of the open strings stretching between the two branes: the open string stretching from F_1 to F_2 will now have ghost number $N_{gh} = +1$, and the string stretching from F_2 to F_1 will have ghost number $N_{gh} = -1$. In summary:

$$\begin{aligned} N_{gh} = 1 & : X_{\bar{2}2} \\ N_{gh} = 0 & : \Lambda_2, \Lambda_{\bar{2}} \\ N_{gh} = -1 & : \Upsilon_{2\bar{2}}. \end{aligned} \tag{4.1}$$

⁹The idea of adding an anti-brane has also been considered in [43]. However our treatment of the open string modes will be rather different

¹⁰Other examples of systems without physical excitations are the $bc\beta\gamma$ quartets in two-dimensional CFT.

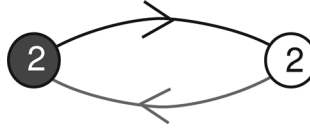

Figure 9: Quiver diagram for the brane/anti-brane system.

The ghost number zero fields generate the following symmetries:

$$\delta X_{22} = \Lambda_{\bar{2}} X_{22} - X_{22} \Lambda_2, \quad \delta \Upsilon_{22} = \Lambda_2 \Upsilon_{22} - \Upsilon_{22} \Lambda_{\bar{2}}. \tag{4.2}$$

Moreover the ghost number minus one field generates a redundancy:

$$\delta \Lambda_2 = \Lambda_{2\bar{2}} X_{\bar{2}2}, \quad \delta \Lambda_{\bar{2}} = X_{\bar{2}2} \Lambda_{2\bar{2}}. \tag{4.3}$$

We can write all this in a more compact form using the BV formalism (for reviews see [56, 57]). We introduce the anti-fields, $\{X_{2\bar{2}}^*, \Lambda_2^*, \Lambda_{\bar{2}}^*, \Upsilon_{22}^*\}$, of ghost numbers $\{2, 3, 3, 4\}$ respectively, and the following bracket:

$$\{A, B\} = \sum_i \frac{\partial_R A}{\partial X_i} \frac{\partial_L B}{\partial X_i^*} - \frac{\partial_R A}{\partial X_i^*} \frac{\partial_L B}{\partial X_i}. \tag{4.4}$$

Here ∂_R, ∂_L denote right and left differentiation. Then we can define an extended superpotential which is a function of all the fields and anti-fields, such that gauge transformations are generated by W itself

$$\delta A = \{W, A\}. \tag{4.5}$$

If we pick the following superpotential:

$$\begin{aligned} W = & X_{2\bar{2}}^* (\Lambda_{\bar{2}} X_{22} - X_{22} \Lambda_2) + \Upsilon_{22}^* (\Lambda_2 \Upsilon_{22} - \Upsilon_{22} \Lambda_{\bar{2}}) \\ & + \Lambda_2^* \Upsilon_{2\bar{2}} X_{\bar{2}2} + \Lambda_{\bar{2}}^* X_{\bar{2}2} \Upsilon_{22} \end{aligned} \tag{4.6}$$

defined on the extended phase space of the B-model, then we reproduce gauge variations (4.2), (4.3). Moreover with this superpotential the BV master equation is satisfied

$$\{W, W\} = 0 \tag{4.7}$$

which just says that the superpotential itself is gauge invariant.

The superpotential (4.6) may presumably be derived more systematically along the following lines. We start with the quiver for two ordinary branes,

which has a $U(2)$ gauge symmetry. The extended superpotential in this case is simply

$$W = \frac{1}{2} \Lambda^{c*} \Lambda_a \Lambda_b f_c^{ab} \quad (4.8)$$

where f_c^{ab} are the structure constants of $U(2)$, Λ_a are the ghost number zero generators of the gauge symmetry (recall they are anti-commuting) and Λ^{c*} the corresponding anti-ghosts. The identity $\{W, W\} = 0$ reduces to the Jacobi identity. Now we apply one unit of spectral flow to the second brane. This shifts the ghost numbers of suitable linear combinations of the Λ_a . There are some sign conventions which we have not completely figured out, but with some suitable signs this procedure should turn (4.8) into (4.6).

For the brane/anti-brane quiver, one cannot construct any gauge invariant operators out of the ghost number one field, so the moduli space consists just of a single point. If we turn on a VEV for the $N_{gh} = +1$ mode, all the degrees of freedom cancel pairwise, and the only state left is the vacuum [55]. The ghost number $+1$ field cancels with the anti-symmetric combination $\Lambda_2 = -\Lambda_{\bar{2}}$, and the ghost number -1 field cancels with the symmetric combination $\Lambda_2 = +\Lambda_{\bar{2}}$. In the extended superpotential, this is manifested as quadratic terms for the fields after we turn on a VEV. This is our model of “nothing.”

Shortly after this paper appeared, it was suggested that in the full ten-dimensional string theory we should interpret topological anti-branes not as ordinary anti-branes but as “ghost-branes.” The world volume theory of N branes and M ghost-branes in the full ten-dimensional string theory should be $\mathcal{N} = 1$ SUSY Yang–Mills theory with the supergroup $U(N|M)$ as gauge group [58]. Due to cancellations in gauge invariant correlation functions, this would give the same answers as in $U(N - M)$ Yang–Mills theory. This is indeed very reminiscent of the structure we have found here. However there is still a puzzle. From the supergroup point of view the ghost number one field $X_{\bar{2}2}$ should be the internal part of the vertex operator for an off-diagonal gauge field of the supergroup. It seems more natural however to say that it gives rise to a physical chiral field in four dimensions. As we will see this will be quite crucial for us because $X_{\bar{2}2}$ is going to give rise to some of the magnetic quarks of the Seiberg dual theory, which are chiral fields. It would be interesting to elucidate this issue.

4.2 The mechanism behind Seiberg duality

Our discussion of the topological brane/anti-brane system puts us in a position to give a proof of Seiberg duality at the level of F -terms. Consider SUSY QCD as in figure 10(a), and add $N_f - N_c$ brane/ghost-brane pairs.

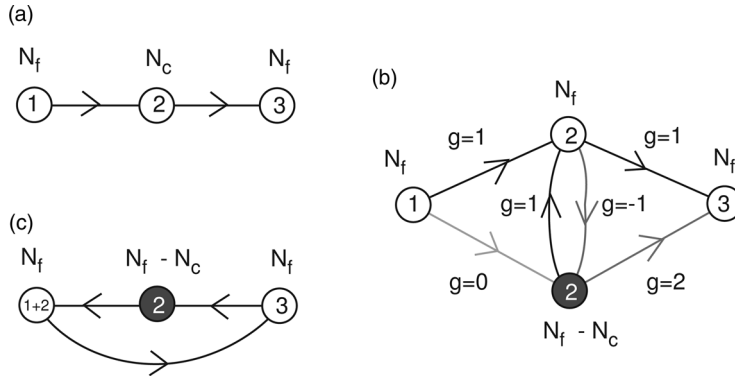

Figure 10: (a) Quiver for SUSY QCD with N_c colors and N_f flavors. (b) Quiver obtained by adding $N_f - N_c$ brane/ghost-brane pairs to (a). (c) Seiberg dual obtained by merging nodes 1 and 2.

The quiver in 10(b) has the following fields:

$$\begin{aligned}
 N_{gh} = 1 & : X_{12}, X_{23}, X_{3\bar{2}}, X_{\bar{2}2}; \\
 N_{gh} = 0 & : \Lambda_2, \Lambda_{\bar{2}}, \Lambda_{1\bar{2}}; \\
 N_{gh} = -1 & : \Upsilon_{2\bar{2}}.
 \end{aligned}
 \tag{4.9}$$

Here we are taking nodes 1 and 3 to be non-dynamical, so we have not included ghost number zero fields for them. We also introduce the anti-fields. By turning on a VEV for $X_{\bar{2}2}$ we go back to the original quiver, and by turning on a VEV for X_{12} we go to the Seiberg dual.

As in the previous subsection, we can obtain the extended superpotential for figure 10(b), which turns out to be:

$$\begin{aligned}
 W = & X_{\bar{2}2} X_{23} X_{3\bar{2}} + X_{3\bar{2}}^* \Upsilon_{2\bar{2}} X_{\bar{2}3}^* + X_{21}^* (-X_{12} \Lambda_2 + \Lambda_{1\bar{2}} X_{\bar{2}2}) + X_{3\bar{2}}^* \Lambda_2 X_{23} \\
 & - X_{23}^* X_{3\bar{2}} \Lambda_{\bar{2}} + X_{\bar{2}2}^* (\Lambda_{\bar{2}} X_{\bar{2}2} - X_{\bar{2}2} \Lambda_2) + \Lambda_{21}^* (-\Lambda_{1\bar{2}} \Lambda_{\bar{2}} + X_{12} \Upsilon_{2\bar{2}}) \\
 & + \Upsilon_{\bar{2}2}^* (\Lambda_2 \Upsilon_{2\bar{2}} - \Upsilon_{2\bar{2}} \Lambda_{\bar{2}}) + \Lambda_2^* \Upsilon_{2\bar{2}} X_{\bar{2}2} + \Lambda_{\bar{2}}^* X_{\bar{2}2} \Upsilon_{2\bar{2}} + W_{\text{gauge}}
 \end{aligned}
 \tag{4.10}$$

where W_{gauge} generates non-abelian gauge transformations, similar to (4.8). If we set all the anti-fields to zero, then we are left over with the following expression:

$$W = X_{\bar{2}2} X_{23} X_{3\bar{2}}.
 \tag{4.11}$$

This will of course descend to the Seiberg dual superpotential.

Let us do some quick counting. Suppose we want to go back to the original quiver by turning on VEVs for $X_{\bar{2}2}$. Since $\delta X_{\bar{2}2} = \Lambda_{\bar{2}} X_{\bar{2}2} - X_{\bar{2}2} \Lambda_2$ is a matrix equation with $N_f(N_f - N_c)$ independent entries, this means there are $N_f^2 + (N_f - N_c)^2 - N_f(N_f - N_c) = N_f^2 + N_c^2 - N_f N_c$ unbroken generators

in Λ_2 and $\Lambda_{\bar{2}}$. Furthermore since $\delta\Lambda_2 = \Upsilon_{2\bar{2}}X_{\bar{2}2}$, $\delta\Lambda_{\bar{2}} = X_{\bar{2}2}\Upsilon_{2\bar{2}}$, the $\Upsilon_{2\bar{2}}$ pair up with an additional $N_f(N_f - N_c)$ generators in Λ_2 and $\Lambda_{\bar{2}}$, leaving just N_c^2 generators, associated with node 2 in the original quiver diagram. Furthermore, because of $\delta X_{12} = \Lambda_{1\bar{2}}X_{\bar{2}2}$, the $N_f(N_f - N_c)$ generators in $\Lambda_{1\bar{2}}$ pair up with an equal number of the X_{12} , leaving us just with the $N_f N_c$ generators in X_{12} as in the original quiver diagram. Similarly, turning on $X_{\bar{2}2}$ yields a mass term for X_{23} and $X_{3\bar{2}}$, and the massless survivors are precisely the original fields.

Instead we could turn on X_{12} , which takes us to the Seiberg dual. The $2N_f^2$ degrees of freedom in Λ_1, Λ_2 are broken to the diagonal N_f^2 , in the process of which the N_f^2 degrees of freedom in X_{12} get eaten. Also because of $\delta\Lambda_{1\bar{2}} = X_{12}\Upsilon_{2\bar{2}}$, the $N_f(N_f - N_c)$ degrees of freedom in $\Lambda_{1\bar{2}}$ pair up with the $N_f(N_f - N_c)$ degrees of freedom in $\Upsilon_{2\bar{2}}$. This leaves us with the Seiberg dual.

The manipulation just performed gives an equivalence at the level of F -terms. It cannot clearly be extended to the full theory because Seiberg duality is not an exact duality. Nevertheless this gives a new perspective on how the degrees of freedom in two dual theories are related.

It is tempting to interpret the extended quiver 10(b) as $U(N_f|N_f - N_c)$ SUSY gauge theory with N_f quarks and N_f anti-quarks. However from this supergroup point of view the magnetic quark fields $X_{\bar{2}2}$ should correspond to off-diagonal vector superfields of the supergroup. This point remains to be clarified.

4.3 Superpotentials via quivers with ghosts

As we reviewed in Section 2, given an exceptional collection of sheaves which generate the derived category (i.e., “fractional branes”), one may obtain another set by applying an operation known as a “mutation”. While the information contained in any of the exceptional collections is equivalent, it is frequently much easier to extract from one collection than from another. Thus one would like a simple set of rules to obtain to transform this information under mutation. So far such a set of rules is known only for exceptional collections that are related by Seiberg duality. Here we discuss a set of rules that is meant to apply for arbitrary mutations, which one may view as “generalized Seiberg dualities.” Using this set of rules in principle makes the computations of the superpotential much more systematic. For instance for the Del Pezzo singularities we can take the exceptional collection

$$\mathcal{O}(0), \mathcal{O}(H), \mathcal{O}(2H), \mathcal{O}_{E_1}, \dots, \mathcal{O}_{E_n}. \quad (4.12)$$

to write down a quiver and superpotential. Clearly this is essentially the same computation for all the Del Pezzo surfaces.

In the following we will start with unphysical but simple to understand quivers which have bifundamental ghosts; such ghosts will be indicated with colored arrows. The game is then to apply mutations to get rid of the colored lines, and end up with a physical quiver.

In order to carry out this procedure we would like a method for deriving the superpotential of the mutated quiver from the original one, without having to do any new calculations with the mutated fractional branes. We saw that for two quivers related by Seiberg duality there is a well-defined method for writing down an intermediate quiver and an extended superpotential by adding brane/anti-brane pairs. We can do the same thing for quivers that are related by a general mutation. We first illustrate the issues in a well-known example based on $\mathbf{P}^1 \times \mathbf{P}^1$. Then we show how it applies to exceptional collections of the form (4.12) for the Del Pezzo surfaces. Along the way, we will see that quantities which only depend on holomorphic data, such as the a -anomaly and the number of dibaryons, can be correctly recovered from quivers with ghosts.

4.4 The quadric: mutation, a -maximization, dibaryons

Our favourite example of a quiver with ghosts is based on the following exceptional collection on $\mathbf{P}^1 \times \mathbf{P}^1$:

$$\begin{aligned}
 &1. \mathcal{O}(-2, -1) \quad 2. \mathcal{O}(-1, -1) \quad 4. \mathcal{O}(0, 0) \\
 &3. \mathcal{O}(-1, 0)
 \end{aligned}
 \tag{4.13}$$

on $\mathbf{P}^1 \times \mathbf{P}^1$. The role of the Ext^0 in this quiver was explained to us by Sheldon Katz as part of a project [5]. Similar observations since then were made independently in [44–46]. For simplicity, we only consider the commutative case in this subsection.

The physical fields are given by

$$\begin{aligned}
 X_{12} &= A_\alpha z^\alpha & X_{24} &= B_{\alpha\dot{\beta}} z^\alpha w^{\dot{\beta}} \\
 X_{13} &= C_{\alpha\dot{\beta}} z^\alpha w^{\dot{\beta}} & X_{34} &= D_\alpha z^\alpha \\
 X_{14} &= E_{\alpha\gamma\dot{\beta}} z^\alpha z^\gamma w^{\dot{\beta}}
 \end{aligned}
 \tag{4.14}$$

After taking spectral flow into account, these correspond to vertex operators of ghost number one. However we also have cohomology classes of ghost

number zero:

$$X_{23} = F_{\dot{\beta}} w^{\dot{\beta}}. \tag{4.15}$$

These are indicated in red in the quiver diagram. The gauge groups are all $U(N)$.

Applying the familiar rules, we get the superpotential

$$W = (A_{\alpha} B_{\gamma \dot{\beta}} + C_{\alpha \dot{\beta}} D_{\gamma}) E^{\alpha \gamma \dot{\beta}}. \tag{4.16}$$

The ghosts generate the following symmetry:

$$\delta C_{\alpha \dot{\beta}} = -A_{\alpha} F_{\dot{\beta}}, \quad \delta B_{\alpha \dot{\beta}} = F_{\dot{\beta}} D_{\alpha} \tag{4.17}$$

which leaves the superpotential invariant. Since as we discussed this is a redundancy, then in order to get the correct moduli space we should mod out by all the gauge groups associated to the nodes as well as the symmetries parametrized by F .

Now we would like to obtain a quiver without ghosts by applying a generalized Seiberg duality, i.e., a mutation. In this case we would like to replace

$$F_{(1)} \rightarrow R_{F_{(2)}} F_{(1)} = \mathcal{O}(0, -1). \tag{4.18}$$

At the level of Chern characters we have

$$\text{ch}(\mathcal{O}(0, -1)) = -[\text{ch}(F_{(1)}) - 2 \text{ch}(F_{(2)})] \tag{4.19}$$

according to the Picard–Lefschetz formula. So we need two copies of $F_{(2)}$ and one copy of $F_{(1)}$ to make $\mathcal{O}(0, -1)$. We first we do an intermediate step by adding brane and anti-brane versions of $F_{(2)} = \mathcal{O}(-1, -1)$ to get an extended quiver diagram.

$$\begin{array}{ccc} \bar{2}. \mathcal{O}(-1, -1)[-2] & \xrightarrow{\oplus} & 2. \mathcal{O}(-1, -1)^2[-1] \\ \oplus & \rightarrow & \oplus \\ 1. \mathcal{O}(-2, -1)[-2] & & 3. \mathcal{O}(-1, 0)[-1] \end{array} \rightarrow 4. \mathcal{O}(0, 0)[0]. \tag{4.20}$$

Since the gauge group associated to node 2 has been enhanced from $U(N)$ to $U(2N)$, there are now effectively twice as many fields corresponding to arrows going into or out of node 2. We will label this explicitly by introducing an index $i = 1, 2$ which keeps track of which of the two nodes with label 2 a field is connected to. In addition we have new fields associated with

the node $\bar{2}$:

$$X_{23} = \tilde{F}_\beta w^\beta, \quad X_{24} = \tilde{B}_{\alpha\beta} z^\alpha w^\beta, \quad X_{22} = U \quad (4.21)$$

as well as extra ghosts

$$X_{1\bar{2}} = \tilde{A}_\alpha z^\alpha. \quad (4.22)$$

The quiver is drawn in figure 12(a). The new superpotential is

$$W = (A_\alpha^i B_{\gamma\beta}^i + C_{\alpha\beta} D_\gamma) E^{\alpha\gamma\beta} + U^i B_{\alpha\beta}^i \tilde{B}^{\alpha\beta} + \tilde{F}_\beta D_\alpha \tilde{B}^{\alpha\beta}. \quad (4.23)$$

The symmetries are now given by

$$\begin{aligned} \delta C_{\alpha\beta} &= -A_\alpha^i F_\beta^i & \delta B_{\alpha\beta}^i &= F_\beta^i D_\alpha & \delta \tilde{F}_\beta &= -U^i F_\beta^i \\ \delta C_{\alpha\beta} &= \tilde{A}_\alpha \tilde{F}_\beta & \delta \tilde{B}^{\alpha\beta} &= -E^{\alpha\gamma\beta} \tilde{A}_\gamma & \delta A_\alpha^i &= \tilde{A}_\alpha U^i. \end{aligned} \quad (4.24)$$

The idea behind these equations is hopefully clear. For every composition of maps we get either a superpotential term or a symmetry. When we add the anti-branes the compositions that go through node 2 are the same as the compositions that go through $\bar{2}$. The only possible difference is in interpretation: when we replace 2 by $\bar{2}$, a superpotential term may give another superpotential term or it may give a symmetry. Hence $A_\alpha^i B_{\gamma\beta}^i E^{\alpha\gamma\beta}$ gives $\delta \tilde{B}^{\alpha\beta} = -E^{\alpha\gamma\beta} \tilde{A}_\gamma$. Similarly a symmetry may give another symmetry or it may give a superpotential term. Hence $\delta C_{\alpha\beta} = -A_\alpha^i F_\beta^i$ gives $\delta C_{\alpha\beta} = \tilde{A}_\alpha \tilde{F}_\beta$ and $\delta B_{\alpha\beta}^i = F_\beta^i D_\alpha$ gives $\tilde{F}_\beta D_\alpha \tilde{B}^{\alpha\beta}$. Finally for every field that goes through node 2 there is a new composition involving its tilde version and the field U . This gives the superpotential terms $U^i B_{\alpha\beta}^i \tilde{B}^{\alpha\beta}$ and the symmetries $\delta \tilde{F}_\beta = -U^i F_\beta^i$, $\delta A_\alpha^i = \tilde{A}_\alpha U^i$.

There is one additional field which is indicated in red in the quiver diagram. Namely apart from X_{22} which has ghost number one, we also have $X_{2\bar{2}}$ which has ghost number *minus* one. Its action on all the fields is somewhat complicated and is best understood by writing the superpotential as a function of all the fields and anti-fields, as in the section on Seiberg duality. However we will only need the action on the ghost number zero fields, which is given by

$$\delta F_\beta^i = X_{2\bar{2}}^i \tilde{F}_\beta, \quad \delta \tilde{A}_\alpha = A_\alpha^i X_{2\bar{2}}^i. \quad (4.25)$$

The next step is to Higgs down to the desired quiver. To this end one turns on expectation values for all the A -fields. Then nodes 1 and 2, which are connected through the A -fields, collapse to the single node associated to $\mathcal{O}(0, -1)$. The $4N^2$ vector multiplets that disappear became massive by eating the $4N^2$ chiral fields A_α^i .

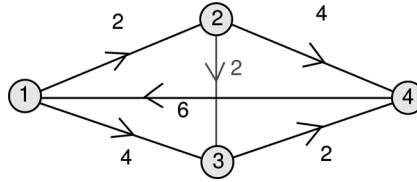

Figure 11: Quiver associated to the exceptional collections (4.13). The ghost fields are indicated by a colored arrow.

When we give an expectation value to A^i_α , the two ghost number -1 fields $X^i_{2\bar{2}}$ cancel with the two ghost number zero fields \tilde{A}_α . Moreover there is a mass term for E and B , as a result of which six of the E 's and six of the B s become massive and are removed from the low energy spectrum. The remaining massless B s can be parametrized by introducing two fields $B_{\dot{\beta}}$ and setting

$$A^i_\alpha B^i_{\dot{\beta}} = B_{\dot{\beta}} \epsilon_{\alpha\gamma} \Leftrightarrow B^i_{\dot{\beta}} = (A^i_\alpha)^{-1} B_{\dot{\beta}} \epsilon_{\alpha\gamma}. \tag{4.26}$$

Then after integrating out the massive degrees of freedom, we are left with the superpotential

$$W = U^i (A^i_\alpha)^{-1} B_{\dot{\beta}} \epsilon_{\alpha\gamma} \tilde{B}^{\gamma\dot{\beta}} + \tilde{F}_{\dot{\beta}} D_\alpha \tilde{B}^{\alpha\dot{\beta}}. \tag{4.27}$$

Up to a field redefinition of the U^i , this is exactly the expected superpotential for figure 12(b). Finally, the C -fields are killed precisely by the symmetry generated by $F^i_{\dot{\beta}}$. Thus we have obtained the correct quiver theory for figure 12(b) by starting with figure 11 and applying a generalized Seiberg duality. This is in agreement with the idea that the F -term information in any quiver obtained from an exceptional collection is equivalent and can be related through generalized Seiberg dualities, or mutations.

We warn the reader that the remainder of this subsection is *rather formal* since we have not defined a physical theory associated to a quiver with

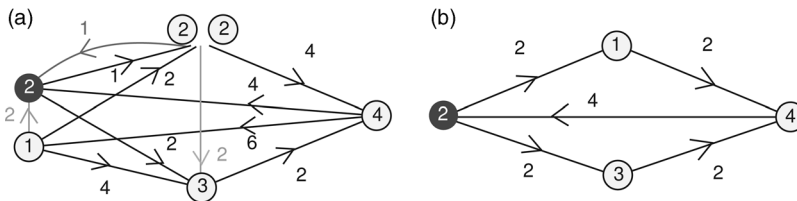

Figure 12: (a) Same quiver as in figure 11 but with brane/anti-brane pair added. (b) Quiver obtained from (a) by condensing the links between nodes 1 and 2. This is the same quiver as in figure 5(b).

ghosts. Nevertheless it indicates that some of the mathematics used for computing F -term quantities in physical quivers can be extended to quivers with ghosts.

R-charges and NSVZ beta-function. For a physical quiver obtained from putting D3-branes at a singularity, the theory flows to $N = 4$ Yang–Mills theory in the IR for generic VEVs, but at the origin of moduli space we expect an interesting $N = 1$ CFT. One may try to compute the R -charges of the fields in the IR by setting the numerator of the NSVZ beta functions for the gauge couplings to zero. Typically one does not find enough constraints, and one employs the strategy of a -maximization to find the correct R -charges as well as the value of the a -anomaly in the IR. Here we will try a similar procedure for the quiver with ghosts of figure 11. For Seiberg dual theories the gauge invariant chiral operators should be identical. Here we also expect to find the correct value of a as well as the correct R -charges for gauge invariant chiral operators when compared with a physical quiver for $\mathbf{P}^1 \times \mathbf{P}^1$, such as in figure 12(b). By gauge invariance we mean both the gauge invariance associated to the nodes as well as the parabolic symmetries.

The numerator of the NSVZ beta function is

$$\beta_i = 3C_2(G) - \sum_{\text{charged chirals}} (1 - 2\gamma_i)T(R_i). \tag{4.28}$$

For $SU(N)$ the second Casimir is $C_2(G) = N$ and the index of the fundamental representation is $T = 1/2$. Moreover at the conformal point the superconformal algebra relates the R -charge and the dimension of an operator as $\Delta = 1 + \gamma = 3R/2$. By the symmetry of the quiver and superpotential we expect that $R_{X_{12}} = R_{X_{34}}$ and $R_{X_{13}} = R_{X_{24}}$. Because of the symmetries $\delta X_{13} = -X_{12}X_{23}$, $\delta X_{24} = X_{23}X_{34}$ we also get $R_{13} = R_{12} + R_{23}$, $R_{24} = R_{23} + R_{34}$. Finally because of this symmetry we know that the Yukawa couplings must be identical, and we expect they have dimension zero.

We still need to specify how to include the contributions from the fields of ghost number zero to the beta function. One can think of X_{23} as giving a contribution to the chiral fields, but because of its ghost number it has opposite statistics, and thus the loop integral which calculates its contribution to the beta function has the same magnitude but the opposite sign from a normal chiral field.

For node 1 one finds

$$3N - \frac{1}{2}(2N(3 - 2\Delta_{X_{12}}) + 6N^2(3 - 2\Delta_{X_{41}}) + 4N(3 - 2\Delta_{X_{13}})) = 0 \tag{4.29}$$

and by symmetry we get the same equation for node 4. Since the superpotential has R -charge 2 we can solve for R_{41} in $R_{41} + R_{12} + R_{24} = R_{41} +$

$R_{12} + R_{13} = 2$ and substitute. This gives

$$R_{13} + 2R_{12} = 1. \tag{4.30}$$

Next we consider nodes 2 and 3 (which will give identical equations):

$$3N - \frac{1}{2}(2N(3 - 2\Delta_{12}) + 4N(3 - 2\Delta_{24}) - 2N(3 - 2\Delta_{23})) = 0. \tag{4.31}$$

Note we have reversed the sign in the contribution for the ghost. Using the previous equations $R_{13} = R_{12} + R_{23}$ and $R_{13} + 2R_{12} = 1$, we find that (4.31) vanishes identically and imposes no new constraint. So we have a one-parameter family of allowed R -charges, parametrized say by R_{12} .

We can compute the 't Hooft anomaly $\text{Trace}(R)$. We get

$$4N^2 + 4N^2(R_{12} - 1) + 8N^2(-2R_{12}) + 6N^2(R_{12}) - 2N^2(-3R_{12}) \tag{4.32}$$

which sums up to zero exactly. The first $4N^2$ is the contribution of the gauginos associated with the four nodes.

Next we will use the proposal by Intriligator and Wecht [47] and maximise the a -anomaly. This yields $R_{12} = \frac{1}{2}$. We then have the following table for the R -charges:

$$\begin{matrix} X_{12} & X_{34} & X_{13} & X_{24} & X_{41} & X_{23} \\ \frac{1}{2} & \frac{1}{2} & 0 & 0 & \frac{3}{2} & -\frac{1}{2} \end{matrix} \tag{4.33}$$

Again we are not bothered by the fact that some of the R -charges in this table are zero or negative. The only criterion is that the gauge invariant operators (the baryons and mesons) have positive R -charge and dimension, and this includes invariance under the parabolic symmetry. Moreover, plugging into the a -anomaly, we get

$$a = \frac{3}{32}(3\text{Tr}(R^3) - \text{Tr}(R)) = \frac{27N^2}{32} \tag{4.34}$$

which is exactly the right answer.

Dibaryon counting. Another check on the R -charges comes from counting dibaryons [48–54]. There should be a 1–1 correspondence between dibaryons of R -charge $2dN/8$ and curves of degree d on $\mathbf{P}^1 \times \mathbf{P}^1$.

Denote by H_1 and H_2 the homology classes for the left and right \mathbf{P}^1 respectively. The degree of a curve is given by intersecting its class with $2H_1 + 2H_2$ using the relations $H_1^2 = H_2^2 = 0$ and $H_1 \cdot H_2 = 1$. The lowest degree rational curves are given by an equation $a_\alpha z^\alpha = 0$ or $b_\beta w^\beta = 0$ and have homology class H_2 or H_1 and degree 2. The moduli space of such curves is given by \mathbf{P}^1 .

Similarly on the quiver side the dibaryons we can write down have R -charge at least $N/2$. We can construct baryonic operators of R -charge $N/2$ as follows. There is one set which we can make out of X_{12} or X_{34} . Recall however from our discussion of the moduli space that $\partial W/\partial X_{41} = 0$ implies $X_{12} \sim X_{34}$, so we can forget about X_{34} because it will not give any new operators. Then we can make dibaryons out of A_1, A_2 of the schematic form

$$(A_1)^s(A_2)^{N-s} \tag{4.35}$$

for $0 \leq s \leq N$. This matches with the fact that a D3-brane wrapped on $H_2 \times S^1$ behaves as an electric particle on the moduli space of the curve H_2 , which is \mathbf{P}^1 with N units of magnetic flux. Quantizing this moduli space, we find the $N + 1$ sections of $\mathcal{O}(N)$ [48]. These dibaryons do indeed have charge $N/2$.

Similarly one can construct eight operators that are invariant under the parabolic symmetry and of ghost number one of the form $X_{12}X_{24} + X_{13}X_{34}$. From the superpotential we get six relations between them, so there are two independent such operators. Then just as with A_1, A_2 we can construct $N + 1$ dibaryons out of them with R -charge $N/2$. These presumably correspond to the states obtained from quantizing the moduli space of D3-branes wrapped on $\mathbf{P}^1 \times S^1$ where the \mathbf{P}^1 has homology class H_1 .

It might be interesting to check some more curves of higher degrees.

4.5 Del Pezzo 3

Let us consider the case of Del Pezzo 3. As before we will encode the NC structure through the tensor f_{ijk} . We choose the following strong exceptional collection (see figure 13)

$$\begin{aligned}
 1. \mathcal{O}(0) \quad 2. \mathcal{O}(H) \quad 3. \mathcal{O}(2H) \quad 4. \mathcal{O}_{E_1} \\
 \quad \quad \quad \quad \quad \quad \quad \quad \quad \quad \quad \quad \quad \quad \quad 5. \mathcal{O}_{E_2} \\
 \quad \quad \quad \quad \quad \quad \quad \quad \quad \quad \quad \quad \quad \quad \quad 6. \mathcal{O}_{E_3}
 \end{aligned} \tag{4.36}$$

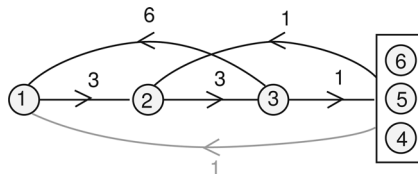

Figure 13: Quiver diagram for (4.36).

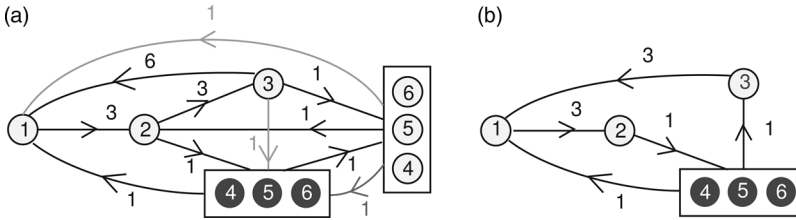

Figure 14: (a) Quiver for (4.42), obtained from figure 13 by adding “anti-branes.” (b) Mutated quiver diagram, which is physical (has no red lines).

The quiver is drawn in Figure 14(a). We will denote the maps as follows:

$$\begin{aligned}
 X_{12} &= A_i z^i & X_{3,456} &= D_i \operatorname{res}_{E_i} \\
 X_{23} &= B_i z^i & X_{2,456} &= E_i^* \operatorname{res}_{E_i} \\
 X_{13} &= C_{ij}^* z^i z^j & X_{1,456} &= F_i^* \operatorname{res}_{E_i}
 \end{aligned}
 \tag{4.37}$$

Here res_{E_i} means “restriction to E_i ,” and as usual we will kill three of the nine components of $(C_{ij}^*)^* = C^{ij}$ by adding Lagrange multipliers Z^k and the mass terms $f_{ijk} C^{ij} Z^k$. Assuming the E_i are exceptional curves obtained from blowing up the points p, q, r respectively, we find the following superpotential

$$W = W_{\mathbf{P}^2} + (p^\sigma)^i B_i D_1 E^1 + (q^\sigma)^i B_i D_2 E^2 + (r^\sigma)^i B_i D_3 E^3
 \tag{4.38}$$

with

$$W_{\mathbf{P}^2} = A_i B_j C^{ij} + f_{ijk} C^{ij} Z^k.
 \tag{4.39}$$

Moreover the F_i correspond to ghosts, so we get the following relations:

$$\begin{aligned}
 \delta E_1 &= p^i F_1 A_i & \delta C^{ij} &= -p^i (p^\sigma)^j D_1 F_1 \\
 \delta E_2 &= q^i F_2 A_i & \delta C^{ij} &= -q^i (q^\sigma)^j D_2 F_2 \\
 \delta E_3 &= r^i F_3 A_i & \delta C^{ij} &= -r^i (r^\sigma)^j D_3 F_3
 \end{aligned}
 \tag{4.40}$$

As one can check, the superpotential is indeed invariant under these symmetries. Clearly one can write down a very similar quiver theory for any of the Del Pezzo surfaces.

Next we would like to do get rid of the ghosts by applying mutations. In the present case it can be accomplished by shifting $\mathcal{O}(2H)$ to the right. Then we get a new sheaf $\tilde{F}(3) = \mathcal{O}(2H - E_1 - E_2 - E_3)$. The charge vectors

are related by

$$\text{ch}(\tilde{F}_{(3)}) = \text{ch}(\mathcal{O}(2H)) - \sum_{i=1}^3 \text{ch}(\mathcal{O}_{E_i}). \tag{4.41}$$

In order to obtain the superpotential for the dual quiver, we first construct the intermediate quiver by adding the antibranes $\mathcal{O}_{E_i}[0]$:

$$\mathcal{O}(0)[-2] \rightarrow \mathcal{O}(H)[-1] \rightarrow \begin{array}{c} \mathcal{O}(2H)[0] \\ \oplus \\ \bigoplus_{i=1}^3 \mathcal{O}_{E_i}[0] \end{array} \rightarrow \bigoplus_{i=1}^3 \mathcal{O}_{E_i}[1]. \tag{4.42}$$

The resulting quiver is drawn in figure 14(b). We have the additional maps

$$\begin{aligned} X_{\overline{456},1} &= \tilde{F}_i & X_{\overline{44}} &= U_1 \\ X_{2,\overline{456}} &= \tilde{E}_i & X_{\overline{55}} &= U_2 \\ X_{3,\overline{456}} &= \tilde{D}_i & X_{\overline{66}} &= U_3 \end{aligned} \tag{4.43}$$

The composition of maps can be easily read off from the sheaves. However our main point is that even if one did not know the sheaves, it would still be straightforward to read the compositions of maps of the extended quiver from the original quiver, and hence find the extended superpotential and symmetries. Clearly there is a correspondence

$$D_i \leftrightarrow \tilde{D}_i, \quad E_i \leftrightarrow \tilde{E}_i, \quad F_i \leftrightarrow \tilde{F}_i. \tag{4.44}$$

The new superpotential is

$$\begin{aligned} W &= W_{\mathbf{P}^2} + (p^\sigma)^i B_i D_1 E^1 + (q^\sigma)^i B_i D_2 E^2 \\ &+ (r^\sigma)^i B_i D_3 E^3 + \tilde{E}_1 U_1 E_1 + \tilde{E}_2 U_2 E_2 + \tilde{E}_3 U_3 E_3 \\ &+ p^i A_i \tilde{E}_1 \tilde{F}_1 + q^i A_i \tilde{E}_2 \tilde{F}_2 + r^i A_i \tilde{E}_3 \tilde{F}_3 \end{aligned} \tag{4.45}$$

and the new symmetries are

$$\begin{aligned} \delta E_1 &= p^i F_1 A_i & \delta C^{ij} &= -p^i (p^\sigma)^j D_1 F_1 & \delta \tilde{F}_1 &= -U_1 F_1 \\ \delta E_2 &= q^i F_2 A_i & \delta C^{ij} &= -q^i (q^\sigma)^j D_2 F_2 & \delta \tilde{F}_2 &= -U_2 F_2 \\ \delta E_3 &= r^i F_3 A_i & \delta C^{ij} &= -r^i (r^\sigma)^j D_3 F_3 & \delta \tilde{F}_3 &= -U_3 \tilde{F}_3 \end{aligned} \tag{4.46}$$

and

$$\begin{aligned} \delta D_1 &= \tilde{D}_1 U_1 & \delta \tilde{E}_1 &= -(p^\sigma)^i B_i \tilde{D}_1 & \delta C^{ij} &= p^i (p^\sigma)^j \tilde{D}_1 \tilde{F}_1 \\ \delta D_2 &= \tilde{D}_2 U_2 & \delta \tilde{E}_2 &= -(q^\sigma)^i B_i \tilde{D}_2 & \delta C^{ij} &= q^i (q^\sigma)^j \tilde{D}_2 \tilde{F}_2 \\ \delta D_3 &= \tilde{D}_3 U_3 & \delta \tilde{E}_3 &= -(r^\sigma)^i B_i \tilde{D}_3 & \delta C^{ij} &= r^i (r^\sigma)^j \tilde{D}_3 \tilde{F}_3. \end{aligned} \tag{4.47}$$

As in the previous example all this information can be easily lifted from the original quiver diagram:

- The superpotential term $(p^\sigma)^i B_i D_1 E^1$, gives rise to the symmetry $\delta \tilde{E}_1 = -(p^\sigma)^i B_i \tilde{D}_1$.
- The symmetry $\delta C^{ij} = -p^i (p^\sigma)^j D_1 F_1$ yields the new symmetry $\delta C^{ij} = p^i (p^\sigma)^j \tilde{D}_1 \tilde{F}_1$.
- The symmetry $\delta E_1 = p^i F_1 A_i$ gives rise to the superpotential term $p^i A_i \tilde{E}_1 \tilde{F}_1$.
- For the new compositions, we add to the superpotential the cubic term $\tilde{E}_1 U_1 E_1$, and we add the symmetries $\delta \tilde{F}_1 = -U_1 F_1$, $\delta D_1 = \tilde{D}_1 U_1$.

Finally there are $X_{4\bar{4}}, X_{5\bar{5}}, X_{6\bar{6}}$ of ghost number minus one which parametrize certain redundancies among the shift symmetries. They are drawn in red.

To get the mutated quiver, we turn on VEVs for D_1, D_2, D_3 . The precise expectation value is not important, so we will just set $\langle D_i \rangle = 1$. Then the ghost number zero fields \tilde{D}_i cancel with the ghost number -1 fields. When turning on the D_i , we get quadratic terms for B_i and E_i , so we should solve for their equations of motion and substitute back. All in all then we are left with the quiver diagram in figure 14(b), with superpotential

$$\begin{aligned}
 W = & f_{ijk} C^{ij} Z^k + p^i A_i \tilde{E}_1 \tilde{F}_1 + q^i A_i \tilde{E}_2 \tilde{F}_2 + r^i A_i \tilde{E}_3 \tilde{F}_3 \\
 & - A_1 \tilde{E}_1 U_1 (m^{11} C^{11} + m^{12} C^{12} + m^{13} C^{13}) \\
 & - A_1 \tilde{E}_2 U_2 (m^{21} C^{11} + m^{22} C^{12} + m^{23} C^{13}) \\
 & - A_1 \tilde{E}_3 U_3 (m^{31} C^{11} + m^{32} C^{12} + m^{33} C^{13}) \\
 & - A_2 \tilde{E}_1 U_1 (m^{11} C^{21} + m^{12} C^{22} + m^{13} C^{23}) \\
 & - A_2 \tilde{E}_2 U_2 (m^{21} C^{21} + m^{22} C^{22} + m^{23} C^{23}) \\
 & - A_2 \tilde{E}_3 U_3 (m^{31} C^{21} + m^{32} C^{22} + m^{33} C^{23}) \\
 & - A_3 \tilde{E}_1 U_1 (m^{11} C^{31} + m^{12} C^{32} + m^{13} C^{33}) \\
 & - A_3 \tilde{E}_2 U_2 (m^{21} C^{31} + m^{22} C^{32} + m^{23} C^{33}) \\
 & - A_3 \tilde{E}_3 U_3 (m^{31} C^{31} + m^{32} C^{32} + m^{33} C^{33}).
 \end{aligned} \tag{4.48}$$

Here

$$m_{ij} = \begin{pmatrix} p_1^\sigma & p_2^\sigma & p_3^\sigma \\ q_1^\sigma & q_2^\sigma & q_3^\sigma \\ r_1^\sigma & r_2^\sigma & r_3^\sigma \end{pmatrix}_{ij} \tag{4.49}$$

and m^{ij} is its inverse. Recall that p^σ is defined to be the unique vector in the kernel of $f_{ijk} p^i$, and similarly for q^σ , r^σ .

This superpotential is still invariant under the remnant symmetry

$$\begin{aligned}
 \delta C^{ij} &= -p^i (p^\sigma)^j F_1 & \delta \tilde{F}_1 &= -U_1 F_1 \\
 \delta C^{ij} &= -q^i (q^\sigma)^j F_2 & \delta \tilde{F}_2 &= -U_2 F_2 \\
 \delta C^{ij} &= -r^i (r^\sigma)^j F_3 & \delta \tilde{F}_3 &= -U_3 F_3
 \end{aligned}
 \tag{4.50}$$

which kills three components of C^{ij} . Once again we can take care of this by adding three Lagrange multipliers and the mass terms

$$\bar{p}_i \bar{p}_j^\sigma C^{ij} Y_1 + \bar{q}_i \bar{q}_j^\sigma C^{ij} Y_2 + \bar{r}_i \bar{r}_j^\sigma C^{ij} Y_3
 \tag{4.51}$$

to the superpotential (4.48). The total superpotential, given by (4.48) plus (4.51), is then our final answer for the physical quiver given in figure 14(b).

We can go one step further and do an additional mutation, to get the exceptional collection (3.34) we studied previously. This mutation actually yields a Seiberg duality on node 2, which was to be expected because we are now mapping a physical ghost-free quiver into another physical quiver. To carry out the Seiberg duality, we introduce the meson fields $L_i = A_i \tilde{E}_1, M_i = A_i \tilde{E}_2, N_i = A_i \tilde{E}_3$ and the dual quarks a^i, h_i . We also modify the superpotential to

$$\begin{aligned}
 W &= f_{ijk} C^{ij} Z^k + \bar{p}_i \bar{p}_j^\sigma C^{ij} Y_1 + \bar{q}_i \bar{q}_j^\sigma C^{ij} Y_2 + \bar{r}_i \bar{r}_j^\sigma C^{ij} Y_3 \\
 &+ p^i L_i \tilde{F}_1 + q^i M_i \tilde{F}_2 + r^i N_i \tilde{F}_3 + h_1 a^i L_i + h_2 a^i M_i + h_3 a^i N_i \\
 &- L_1 U_1 (m^{11} C^{11} + m^{12} C^{12} + m^{13} C^{13}) \\
 &- M_1 U_2 (m^{21} C^{11} + m^{22} C^{12} + m^{23} C^{13}) \\
 &- N_1 U_3 (m^{31} C^{11} + m^{32} C^{12} + m^{33} C^{13}) \\
 &- L_2 U_1 (m^{11} C^{21} + m^{12} C^{22} + m^{13} C^{23}) \\
 &- M_2 U_2 (m^{21} C^{21} + m^{22} C^{22} + m^{23} C^{23}) \\
 &- N_2 U_3 (m^{31} C^{21} + m^{32} C^{22} + m^{33} C^{23}) \\
 &- L_3 U_1 (m^{11} C^{31} + m^{12} C^{32} + m^{13} C^{33}) \\
 &- M_3 U_2 (m^{21} C^{31} + m^{22} C^{32} + m^{23} C^{33}) \\
 &- N_3 U_3 (m^{31} C^{31} + m^{32} C^{32} + m^{33} C^{33}).
 \end{aligned}
 \tag{4.52}$$

After some simple field redefinitions this superpotential coincides exactly with the superpotential we obtained previously (3.40).

Acknowledgments

It is a pleasure to thank S. Benvenuti, F. Cachazo, S. Franco, N. Itzhaki, S. Katz, T. Nevins, L. Rastelli, C. Vafa and H. Verlinde for discussions. This material is based upon work supported by the National Science Foundation Grant no. PHY-0243680. Any opinions, findings and conclusions or recommendations expressed in this material are those of the authors and do not necessarily reflect the views of the National Science Foundation.

References

- [1] M. Green, J. Schwarz and E. Witten, *Superstring theory*, vol. 2, Cambridge University Press, 1987.
- [2] M. Wijnholt, *Large volume perspective on branes at singularities*, Adv. Theor. Math. Phys. **7** (2004), 1117; arXiv:hep-th/0212021.
- [3] H. Verlinde and M. Wijnholt, *Building the standard model on a D3-brane*, preprint, arXiv:hep-th/0508089.
- [4] F. Cachazo, B. Fiol, K.A. Intriligator, S. Katz and C. Vafa, *A geometric unification of dualities*, Nucl. Phys. B **628** (2002), 3; arXiv:hep-th/0110028.
- [5] F. Cachazo, S. Katz, C. Vafa and M. Wijnholt, unpublished.
- [6] D. Berenstein, V. Jejjala and R.G. Leigh, *Marginal and relevant deformations of $N = 4$ field theories and non-commutative moduli spaces of vacua*, Nucl. Phys. B **589** (2000), 196; arXiv:hep-th/0005087.
- [7] D. Berenstein, V. Jejjala and R.G. Leigh, *Noncommutative moduli spaces and T duality*, Phys. Lett. B **493** (2000), 162; arXiv:hep-th/0006168.
- [8] D. Berenstein and R.G. Leigh, *Resolution of stringy singularities by non-commutative algebras*, JHEP **0106** (2001), 030; arXiv:hep-th/0105229.
- [9] J.H. She, *Winding string condensation and noncommutative deformation of spacelike singularity*, Phys. Rev. D **74** (2006), 046005; arXiv:hep-th/0512299.
- [10] C.P. Herzog and R.L. Karp, *Exceptional collections and D-branes probing toric singularities*, preprint, arXiv:hep-th/0507175.
- [11] A. Bergman and N.J. Proudfoot, *Moduli spaces for D-branes at the tip of a cone*, preprint, arXiv:hep-th/0510158.
- [12] D. Auroux, L. Katzarkov and D. Orlov, *Mirror symmetry for del pezzo surfaces: vanishing cycles and coherent sheaves*, ArXiv Mathematics e-prints, 2005, arXiv:math/0506166.

- [13] M.R. Douglas, *D-branes, categories and $N = 1$ supersymmetry*, J. Math. Phys. **42** (2001), 2818; arXiv:hep-th/0011017.
- [14] E. Witten, *Chern–Simons gauge theory as a string theory*, Prog. Math. **133** (1995), 637; arXiv:hep-th/9207094.
- [15] K. Hori, A. Iqbal and C. Vafa, *D-branes and mirror symmetry*, preprint, arXiv:hep-th/0005247.
- [16] M.R. Douglas, B. Fiol and C. Romelsberger, *The spectrum of BPS branes on a noncompact Calabi–Yau*, JHEP **0509** (2005), 057; arXiv:hep-th/0003263.
- [17] P.S. Aspinwall, *D-branes, pi-stability and Theta-stability*, preprint, arXiv:hep-th/0407123.
- [18] E. Witten, *Mirror manifolds and topological field theory*, preprint, arXiv:hep-th/9112056.
- [19] J.T. Stafford and M. Van den Bergh, ArXiv Mathematics e-prints, 1999, arXiv:math/9910082.
- [20] A. Kapustin, *Topological strings on noncommutative manifolds*, Int. J. Geom. Meth. Mod. Phys. **1** (2004), 49; arXiv:hep-th/0310057.
- [21] S.J. Gates, C.M. Hull and M. Rocek, *Twisted multiplets and new supersymmetric nonlinear sigma models*, Nucl. Phys. B **248** (1984), 157.
- [22] N. Hitchin, *Generalized Calabi–Yau manifolds*, Q. J. Math. **54** (2003), no. 3, 281–308; arXiv:math.DG/0209099.
- [23] M. Gualtieri, *Generalized complex geometry*, Oxford University, DPhil thesis, arXiv:math.DG/0401221.
- [24] M. Artin, J. Tate and M. van den Bergh, *Some algebras associated to automorphisms of elliptic curves*, The Grothendieck Festschrift, vol. I, Progr. Math. **86** (1990), 33–85, Birkhäuser, Boston.
- [25] R.G. Leigh and M.J. Strassler, *Exactly marginal operators and duality in four-dimensional $N=1$ supersymmetric gauge theory*, Nucl. Phys. B **447** (1995), 95; arXiv:hep-th/9503121.
- [26] A. Odesskii, *Elliptic algebras*, Russ. Math. Surveys **57** (2002), 6; arXiv:math.qa/0303021.
- [27] S. Benvenuti and A. Hanany, *Conformal manifolds for the conifold and other toric field theories*, JHEP **0508** (2005), 024; arXiv:hep-th/0502043.
- [28] O. Lunin and J. Maldacena, *Deforming field theories with $U(1) \times U(1)$ global symmetry and their gravity duals*, JHEP **0505** (2005), 033; arXiv:hep-th/0502086.
- [29] R.C. Myers, *Dielectric-branes*, JHEP **9912** (1999), 022; arXiv:hep-th/9910053.

- [30] J. Polchinski and M.J. Strassler, The string dual of a confining four-dimensional gauge theory, arXiv:hep-th/0003136.
- [31] N. Dorey and T.J. Hollowood, *On the Coulomb branch of a marginal deformation of $N = 4$ SUSY Yang–Mills*, JHEP **0506** (2005), 036; arXiv:hep-th/0411163.
- [32] F. Benini, *The Coulomb branch of the Leigh–Strassler deformation and matrix models*, JHEP **0412** (2004), 068; arXiv:hep-th/0411057.
- [33] P.S. Aspinwall and S. Katz, *Computation of superpotentials for D-branes*, arXiv:hep-th/0412209.
- [34] I.R. Klebanov and M.J. Strassler, *Supergravity and a confining gauge theory: duality cascades and χ SB-resolution of naked singularities*, JHEP **0008** (2000), 052; arXiv:hep-th/0007191.
- [35] J.M. Maldacena and C. Nunez, *Towards the large N limit of pure $N = 1$ super Yang Mills*, Phys. Rev. Lett. **86** (2001), 588; arXiv:hep-th/0008001.
- [36] C. Vafa, *Superstrings and topological strings at large N* , J. Math. Phys. **42** (2001), 2798; arXiv:hep-th/0008142.
- [37] M.R. Douglas and G.W. Moore, *D-branes, quivers, and ALE instantons*, preprint, arXiv:hep-th/9603167.
- [38] S. Franco, A. Hanany, K.D. Kennaway, D. Vegh and B. Wecht, *Brane dimers and quiver gauge theories*, preprint, arXiv:hep-th/0504110.
- [39] A. Hanany and D. Vegh, *Quivers, tilings, branes and rhombi*, preprint, arXiv:hep-th/0511063.
- [40] B. Feng, Y.H. He, K.D. Kennaway and C. Vafa, *Dimer models from mirror symmetry and quivering amoebae*, preprint, arXiv:hep-th/0511287.
- [41] P. Mayr, *Phases of supersymmetric D-branes on Kaehler manifolds and the McKay correspondence*, JHEP **0101** (2001), 018; arXiv:hep-th/0010223.
- [42] D. Auroux, L. Katzarkov and D. Orlov, ArXiv Mathematics e-prints, 2004, arXiv:math/0404281.
- [43] D. Berenstein and M.R. Douglas, *Seiberg duality for quiver gauge theories*, preprint, arXiv:hep-th/0207027.
- [44] J. McGreevy and S. Hellerman, unpublished.
- [45] P.S. Aspinwall and I.V. Melnikov, *D-branes on vanishing del Pezzo surfaces*, JHEP **0412** (2004), 042; arXiv:hep-th/0405134.
- [46] C.P. Herzog, *Seiberg duality is an exceptional mutation*, JHEP **0408** (2004), 064; arXiv:hep-th/0405118.

- [47] K. Intriligator and B. Wecht, *The exact superconformal R-symmetry maximizes a*, Nucl. Phys. B **667** (2003), 183; arXiv:hep-th/0304128.
- [48] E. Witten, *Baryons and branes in anti de Sitter space*, JHEP **9807** (1998), 006; arXiv:hep-th/9805112.
- [49] S. Gukov, M. Rangamani and E. Witten, *Dibaryons, strings, and branes in AdS orbifold models*, JHEP **9812** (1998), 025; arXiv:hep-th/9811048.
- [50] D. Berenstein, C.P. Herzog and I.R. Klebanov, *Baryon spectra and AdS/CFT correspondence*, JHEP **0206** (2002), 047; arXiv:hep-th/0202150.
- [51] C.E. Beasley and M.R. Plesser, *Toric duality is Seiberg duality*, JHEP **0112** (2001), 001; arXiv:hep-th/0109053.
- [52] C.E. Beasley, *BPS branes from baryons*, JHEP **0211** (2002), 015, arXiv:hep-th/0207125.
- [53] C.P. Herzog and J. McKernan, *Dibaryon spectroscopy*, JHEP **0308** (2003), 054; arXiv:hep-th/0305048.
- [54] C.P. Herzog and J. Walcher, *Dibaryons from exceptional collections*, JHEP **0309** (2003), 060; arXiv:hep-th/0306298.
- [55] C. Vafa, *Brane/anti-brane systems and $U(N-M)$ supergroup*, preprint, arXiv:hep-th/0101218.
- [56] E. Witten, *A note on the antibracket formalism*, Mod. Phys. Lett. A **5** (1990), 487.
- [57] S. Weinberg, *The quantum theory of fields. Vol. 2: Modern applications*, Cambridge University Press, UK, 1996, 489p.
- [58] T. Okuda and T. Takayanagi, *Ghost D-branes*, JHEP **0603** (2006), 062; arXiv:hep-th/0601024.